

WBA Operations Manual

Wholesale Broadband Agreement





WBA Operations Manual

Wholesale Broadband Agreement

nbn® Networks: Fibre, FTTB, FTTN, FTTC, HFC, Wireless and Satellite



Version	Description	Effective Date
5.0	First issued version of WBA 5	1 December 2023
5.1	Amendment to introduce NNI Diversity Upgrade	31 March 2024
5.2	Amendments for Fixed Wireless High Speed Tiers	27 May 2024
5.3	Changes to give RSPs the ability to cancel Trouble Tickets in specified circumstances through the nbn ® Service Portal and B2B Access	25 June 2024
5.4	Expiry of Continued Ordering Period for UNI-V and Battery Backup for nbn Ethernet (Fibre)	26 June 2024
5.5	Changes to Site Induction Course accreditation term and simplification of Minimum Modem Quality Standards (MMQS) testing.	17 July 2024
5.6	Updating WBA to align with NBN Access Transfer Industry Code Update definition of Fibre Connect Eligible Orders to refer to updated definition in the Fibre Connect Program Letter Agreement. Introduce Co-location augmentation with replacement	1 October 2024 3 October 2024
5.7	Fibre Upgrade Installation process clarifications	1 December 2024
5.8	Changes for Service Levels and Operational Targets for Fixed Wireless in Isolated and Limited Access Areas	1 March 2025
5.9	Withdraw a number of non-recurring charges, that are currently not in use or have never been used	12 March 2025
5.10	Updating WBA to change date for NBN Access Transfer Industry Code	1 April 2025
5.11	Amendments for CVC Max bandwidth profile	13 April 2025
5.12	Update regarding use of comments section as enquiry channel for Assurance Enquiries	1 July 2025
5.13	Amendments for Accelerating Great and Speed related Performance Incidents for FTTP	14 September 2025
5.14	Amendments to Pending Order cancellation process	1 January 2026
5.15	Amendments for Speed related Performance Incident for HFC	19 April 2026

Copyright

This document is subject to copyright and must not be used except as permitted below or under the Copyright Act 1968 (Cth). You must not reproduce or publish this document in whole or in part for commercial gain without the prior written consent of **nbn**. You may reproduce and publish this document in whole or in part for educational or non-commercial purposes as approved by **nbn** in writing.

Copyright © 2026 **nbn co** Limited. All rights reserved. Not for general distribution.

Disclaimer

This document is provided for information purposes only. The recipient must not use this document other than with the consent of **nbn** and must make its own inquiries as to the currency, accuracy and completeness of this document and the information contained in it. The contents of this document should not be relied upon as representing **nbn**'s final position on the subject matter of this document, except where stated otherwise. Any requirements of **nbn** or views expressed by **nbn** in this document may change as a consequence of **nbn** finalising formal technical specifications, or legislative and regulatory developments.

Environment

nbn asks that you consider the environment before printing this document.



Table of Contents

Module 1:	Introduction	10
1.1	What is the WBA Operations Manual?	11
1.1.1	A Living Document	11
1.1.2	nbn® Operations User Guide	11
1.1.3	Modules	11
1.1.4	Role Descriptions	12
1.2	Interaction Diagrams	12
1.3	Terminology	13
1.3.1	Interpretation	13
1.3.2	Content	13
1.4	Contacts and the Contact Matrix	14
1.4.1	Maintaining the Contact Matrix	14
1.4.2	Communication Channels	14
1.4.3	RSP Enquiry	14
Module 2:	On-boarding	16
2.1	In This Module	17
2.1.1	Introduction	17
2.1.2	The On-boarding Roadmap	17
2.1.3	Workshops and Training	18
2.2	Conduct Initial On-boarding	18
2.2.1	Define Solution	18
2.2.2	Conduct Pre-Certification Testing	19
2.2.3	Conduct Interoperability Certification Testing	20
2.2.4	Attend Operational Workshop	21
2.2.5	Conduct Operational Accreditation Testing (OAT)	24
2.3	Authority to Order Products	25
2.4	Conduct Supplemental On-boarding Activities	25
2.4.1	Communicate Changes to Offerings	25
2.4.2	Conduct On-boarding for Future Functionality	26
Module 3:	Physical Access	27
3.1	In This Module	28
3.2	Site Induction	28
3.2.1	Physical Access Requests	28
3.2.2	Site Induction Course	28

3.2.3	Electronic Access Cards	29
3.2.4	Physical Key Requests	30
3.2.5	Ordering Electronic Access Cards and Keys	30
3.2.6	Dispatch and Delivery	31
3.3	Electronic Access Cards and Key Maintenance	32
3.3.1	Lost, Stolen or Missing Electronic Access Cards and Keys	32
3.3.2	Lost Electronic Access Cards or Keys: Required information	32
3.3.3	Damaged or Faulty Electronic Access Cards and Keys	33
3.3.4	Transferring Use of Electronic Access Cards and Keys	33
3.3.5	Updating Keys	33
3.3.6	Renewing an Electronic Access Card	34
3.3.7	Returning Electronic Access Cards and Keys	34
3.4	Occupational Health, Safety & Environment Requirements	35
3.4.1	General OH&S and Environment Rules	35
3.4.2	High Risk Works	37
3.4.3	Health, Safety and Environment Audits	37
3.4.4	Health, Safety and Environment Hazard and Incident Notification	38
3.5	Planned Access or Emergency Access	38
3.5.1	Site Entry Prerequisites	38
3.5.2	Requesting Planned Access or Emergency Access	39
3.5.3	Basic Responsibilities	39
3.5.4	Site-specific Requirements	39
3.5.5	Escorted and Unescorted Physical Access	40
3.5.6	Deliveries	42
3.6	Breaches of Access Rules and Procedures	43
3.6.1	Physical Access Refusal or Revocation	43
3.6.2	Compliance Requirements	43
3.7	nbn [®] Building Entry Service (Type 1 Facilities only)	43
3.7.1	Installation of Lead-in or Backhaul Transmission Cables	43
3.7.2	Arranging Physical Access to use the nbn [®] Building Entry Service	43
Module 4:	Activations	45
4.1	In This Module	46
4.2	nbn Rollout Forecasts	46
4.2.1	Rollout Plans	46
4.2.2	One-off Address Queries	47
4.3	Site Qualification	48
4.3.1	Site Qualification Enquiries	48
4.3.2	Historical Footprint List	52

4.4	Products	54
4.4.1	Product Components: Ordering Sequence	54
4.5	Orders	56
4.5.1	About Orders	56
4.5.2	Connect Orders	69
4.5.3	Enhanced Fault Rectification Service	97
4.5.4	Modify Orders	97
4.5.5	Disconnect Orders	105
4.5.6	Temporary POI Migration Orders	108
4.5.7	Same POI Migration Orders	112
4.5.8	NNI Link and V-NNI	115
4.6	Installing nbn [®] Equipment	117
4.6.1	Installation and Charges	118
4.6.2	Installation Guides	118
4.6.3	Standard Installations and Non Standard Installation	118
4.6.4	Activities: Installation	124
4.6.5	Subsequent Installations of NTDs	128
4.6.6	nbn [®] Ethernet (HFC) Installation Options	130
4.6.7	nbn [®] Ethernet (FTTC) - Installation Options	138
4.7	Rearranging/Removing/Repairing Connecting Equipment	146
4.7.1	Interactions: Rearrangement, Removal or Repair	146
4.7.2	Equipment Modification	148
4.8	Changes of Access Technology	148
4.8.1	Process Initiation	148
4.8.2	COAT Process	149
Module 5:	Assurance	153
5.1	In This Module	154
5.2	RSP-Reported Fault Rectification	154
5.2.1	Test & Diagnostics	155
5.2.2	Trouble Tickets	158
5.2.3	Raising, Validating and Resolving a Trouble Ticket	161
5.2.4	Priority Assistance Trouble Tickets	169
5.2.5	Battery Alarm Processes	170
5.2.6	External Faults	172
5.2.7	Resolving Service Faults and Performance Incidents	174
5.2.8	Network Activity	176
5.2.9	Interference Mitigation	179
5.2.10	Trouble Ticket Queries	181

5.2.11	Updating a Trouble Ticket	181
5.2.12	Requesting a Technical Bridge	182
5.2.13	Resolving and Closing a Trouble Ticket	182
5.2.14	Cancelling a Trouble Ticket	186
5.2.15	Escalating an Unresolved Trouble Ticket	187
5.2.16	End User Faults and End User Incidents related to a Network Fault	187
5.2.17	Performance Incidents	187
5.2.18	Self Replacement - FTTC	189
5.3	Service Requests	191
5.3.1	Raising Service Requests	191
5.3.2	Minimum Modem Quality Standards (MMQS)	191
5.3.3	Modem Registration	192
5.3.4	nbn Support for Modem Performance Optimisation	195
5.4	Network Fault Rectification	195
5.4.1	Infrastructure Restoration Trouble Tickets	195
5.4.2	Customer Impact Statement Reports for Network Faults	196
5.5	Planned Outages and Emergency Outages	197
5.5.1	Planned Outage	197
5.5.2	HFC Rollout Planned Outage	199
5.5.3	FTTC Rollout Planned Outage	199
5.5.4	Same POI Migration Planned Outage	199
5.5.5	Fibre Upgrade Outage	199
5.5.6	NNI Migration Outage	200
5.5.7	NTD Replace Outage	200
5.5.8	Planned Outage Queries	200
5.5.9	Emergency Outages	200
5.5.10	Embargo Periods	201
5.5.11	Sun Transit Events	201
5.6	Network protection	201
5.6.1	Repair Profile	201
Module 6:	Appointments	203
6.1	In This Module	204
6.1.1	Introduction	204
6.1.2	Appointment Scenarios	204
6.2	Appointment Overview	204
6.2.1	Appointment Status; description	204
6.2.2	Appointment Life Cycle	206
6.2.3	Appointment Blocks	207

6.2.4	Appointment Completion and Communicating Changes	207
6.2.5	Appointment Communication Responsibilities	207
6.2.6	Appointments and Personal Information	209
6.2.7	Querying the Status of an Appointment	209
6.2.8	Reserved Appointments	209
6.2.9	Priority Assistance Appointments	210
6.3	New Appointments	210
6.3.1	Appointment IDs	211
6.3.2	New Appointment Process	211
6.3.3	Appointment Windows	214
6.4	Rescheduling Appointments	214
6.4.1	Updating and Rescheduling an Appointment	215
6.4.2	Permitted Reasons for Rescheduling	217
6.4.3	Rescheduling Limitations	218
6.4.4	Rescheduling Notifications	218
6.5	Cancelling Appointments	218
6.5.1	Cancelled Appointment (by your Organisation)	218
6.5.2	Cancelled Appointment (by nbn)	219
6.5.3	Required notice periods for Appointment cancellation by your organisation	219
6.6	Missed Appointments	220
6.6.1	Missed Appointments (by your Organisation)	220
6.6.2	Missed Appointments (by nbn)	220
6.7	Installation Specific Processes	221
6.7.1	Selecting Appointments	221
6.7.2	Order Lead Times	225
6.7.3	Availability of Accelerated Appointments	226
6.8	Trouble Ticket Specific Processes	226
6.8.1	Trouble Ticket – Fault Location	226
Module 7:	Event Management	228
7.1	In this Module	229
7.2	Risk of Service or Network Impact (ROSNI)	229
7.2.1	ROSNI	229
7.2.2	ROSNI Updates	229
7.2.3	ROSNI Closure	229
7.3	Force Majeure	229
7.3.1	Force Majeure Event Notice	230
7.3.2	Force Majeure Event Updates	230
7.3.3	Force Majeure Event Closure	230

Module 8:	Billing and Payments	231
8.1	In This Module	232
8.2	About Billing	232
8.3	Billing Periods	232
8.4	Invoicing	232
8.4.1	Forms of Invoice	232
8.4.2	Late Issuing of Forms of Invoice	235
8.5	Claims Process for Rebates and Credits	235
8.5.1	Credits and Rebates	236
8.6	Credits for Satellite Test Services	237
8.7	Payment	237
8.7.1	nbn [®] Bank Account	237
8.7.2	Remittance Advice	237
8.7.3	Record of Payments in Next Invoice	238
8.8	Billing Enquiries and Disputes	238
8.8.1	Authorised Contacts	238
8.8.2	Raising a Billing Enquiry	238
8.8.3	Submitting a Billing Dispute Form	239
8.8.4	Changing the Notification Email Address for Billing Matters	239
Module 9:	Operational Governance	240
9.1	In This Module	241
9.2	Operational Governance	241
9.2.1	Governance Processes	241
9.2.2	Scope	241
9.2.3	Governance Reports	241
9.2.4	Governance Meetings	242
9.2.5	Governance Action Items	243
9.2.6	Requests for ad hoc Reports	243
9.3	Operational Reporting	244
9.3.1	Supplementary Service Level Reports	244
9.3.2	Wireless performance reporting	245
9.3.3	Line Rate and Information Rate reporting	246

Module 1: Introduction



1.1 What is the WBA Operations Manual?

This document is the [WBA Operations Manual](#) which forms part of the [Wholesale Broadband Agreement](#) between **nbn** and your organisation. It describes the processes and procedures that apply to the operational aspects of the supply of Products by **nbn** to your organisation under the [WBA](#), except to the extent that a specific Operations Manual applies in connection with a Product, such as for **nbn**[®] Enterprise Ethernet.

1.1.1 A Living Document

As **nbn** continues to roll out the **nbn**[®] Network, it will develop and refine its operational processes throughout the term of the [WBA](#).

As these changes occur, **nbn** will make corresponding additions and refinements to this document. This will result in changes to the format and content of this document over time as **nbn** introduces new capabilities, and **nbn** and your organisation learn how to operate more effectively and efficiently together.

nbn intends to engage actively with your organisation and Other RSPs in developing these processes.

The [WBA Operations Manual](#) contains content that is applicable to all networks comprising the **nbn**[®] Network (except the Enterprise Ethernet Network – see the [nbn](#)[®] Enterprise Ethernet Operations Manual). The content relevant to your organisation will depend on the agreements entered into between **nbn** and your organisation.

Note: Module F of the [Head Terms](#) sets out how this document may be changed.

1.1.2 **nbn**[®] Operations User Guide

The **nbn**[®] *Operations User Guide* is a companion document that provides step-by-step work instructions and guidelines for activities that relate to the interactions described in this document.



Important: The **nbn**[®] *Operations User Guide* does not form part of this document or the WBA.

Your organisation can obtain a copy of the latest release of the **nbn**[®] *Operations User Guide* from **nbn**'s Website or by contacting the **nbn** Relationship Point of Contact.

1.1.3 Modules

This document is divided into a series of modules, each of which describes a discrete aspect of the operational interactions between your organisation and **nbn**.

Module	Content
2. On-boarding	Describes the processes and activities that provide accreditation required to order Products.
3. Physical Access	Describes the interactions and activities that allow your organisation to access Type 1 Facilities and Type 2 Facilities in connection with the supply of the Facilities Access Service.
4. Activations	Describes the interactions and activities that apply to the ordering and provisioning of Products.
5. Assurance	Describes the processes and interactions that apply to the management and resolution of Service Faults and other service-related issues.
6. Appointments	Describes the processes and interactions that apply in connection with Appointments for both orders and Trouble Tickets

Module	Content
7. Event Management	Describes the processes and interactions that apply in the event of a risk of a network impact or if nbn is the Affected Party in a Force Majeure Event.
8. Billing and Payments	Describes the billing processes and requirements that apply in connection with Products.
9. Operational Governance	Describes the types of reporting that nbn will make available to your organisation and the governance processes that will apply in relation to nbn 's operational performance.

1.1.4 Role Descriptions

Role	Description
RSP Support Centre	RSP Support Centre provides the 'front-of-house' function at nbn . The methods of communication with this team are via the nbn [®] Service Portal, B2B Access, telephone and email. RSP Support Centre is responsible for the following: <ul style="list-style-type: none"> • Responding to general, order-related and Service Fault / Trouble Ticket enquiries • Providing overall operational support.
Service Activation Centre (SAC)	SAC is responsible for the fulfilment of your organisation's orders.
Workforce Management	Workforce Management determines and coordinates nbn 's workforce capacity to address Activations (see Module 4: Activations) and Assurance (see Module 5: Assurance) issues. Your organisation's (and Other RSPs) forecasts and nbn 's historical data comprise the bulk of the information used by Workforce Management to perform this task.

1.2 Interaction Diagrams

The key purpose of this document is to describe the operational interactions that can occur between your organisation and **nbn**.

To help illustrate these interactions, this document uses interaction diagrams, based on the Business Process Model & Notation (BPMN) v2.0 'Choreography' model.

Note: Interaction diagrams are a refinement of the information contained in process diagrams, focussing on the messages (interactions) that **nbn** and your organisation exchange.

Interaction diagrams provide an at-a-glance summary of the interactions relating to a particular operational aspect. They also indicate the general sequence in which these interactions are likely to occur, and if relevant, the circumstances that may trigger the interaction. However, they do not indicate the amount of time that elapses between the interactions.



Important: Interaction diagrams are for illustrative purposes and for assistance only. They do not govern **nbn**'s and your organisation's rights and obligations and are not contractually binding on either **nbn** or your organisation.

The following diagram breaks down the elements of an interaction diagram, as used in this document:

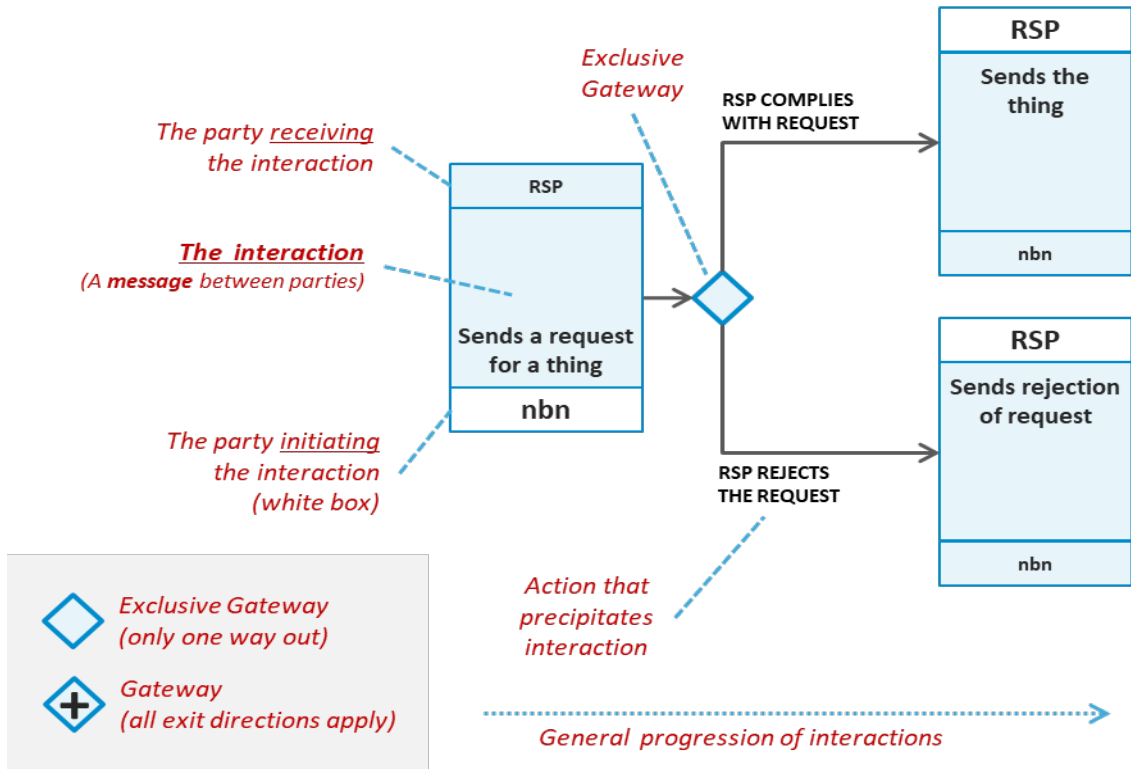

1.3 Terminology

1.3.1 Interpretation

Capitalised terms have the meanings given to those terms in the [Dictionary](#) of the [WBA](#).

1.3.2 Content

Where it is agreed that **nbn** will supply products or services to your organisation by means of particular networks that form part of the **nbn**[®] Network, the content in this document that relates to those networks will apply to your organisation.

Unless otherwise indicated, all content in this document relates to the products or services offered under the [WBA](#), being:

- **nbn**[®] Ethernet (Fibre)
- **nbn**[®] Ethernet (FTTB)
- **nbn**[®] Ethernet (FTTN)
- **nbn**[®] Ethernet (FTTC)
- **nbn**[®] Ethernet (HFC)
- **nbn**[®] Ethernet (Wireless)
- **nbn**[®] Ethernet (Satellite)
- Facilities Access Service
- **nbn**[®] Platform Interfacing Service
- Sandpit
- Any other products or services introduced under the [WBA](#) from time to time.

Where content relates only to **nbn**[®] Ethernet (Fibre), **nbn**[®] Ethernet (FTTB), **nbn**[®] Ethernet (FTTN), **nbn**[®] Ethernet (FTTC), **nbn**[®] Ethernet (HFC), **nbn**[®] Ethernet (Wireless) or **nbn**[®] Ethernet (Satellite) (as applicable), this document uses the following icons:



The FTTB/N icon refers to content that relates to both **nbn**[®] Ethernet (FTTB) and **nbn**[®] Ethernet (FTTN).

In the absence of one of the above symbols, content will relate to all products or services supplied by **nbn**.

1.4 Contacts and the Contact Matrix

When complete, the **Contact Matrix** sets out the contact details for the Personnel from both **nbn** and your organisation who can be contacted in relation to the interactions described in the WBA. The **Contact Matrix** will be created during On-boarding, see section [2.2.4.1 Hold Operational Workshop](#).

Your organisation may obtain a copy of the **Contact Matrix** by contacting the **nbn**[®] Relationship Point of Contact.

1.4.1 Maintaining the Contact Matrix

Both **nbn** and your organisation must ensure that the **Contact Matrix** contains up-to-date details of its Personnel in accordance with clause H1.3 of the [Head Terms](#), and (with the exception of changes to your organisation's Authorised Contacts which are dealt with in section [8.8.1.1 Changing Authorised Contacts](#)), must advise each other in writing of any changes to those Personnel or their contact details within 2 Business Days of the change.

1.4.2 Communication Channels

Any communication from a party to the other party in relation to this document may be given through any of the following channels:

- Email
- Letter
- The **nbn**[®] Service Portal



Important: B2B Access cannot be used for this purpose, except for the limited communications specifically set out in the B2B Specifications.

- Any other form of communication as may be notified by **nbn** to your organisation from time to time.

Different notification requirements apply to any contentious matter or dispute: see clauses H1.1 (e) and H1.1 (f) of the [Head Terms](#).

Each communication in relation to this document must be given to the other party's relevant contact as specified in the **Contact Matrix**, or as otherwise provided in this document.



Important: Where a section of this document or clause H1.1 of the [Head Terms](#) requires a communication to be given in a specific manner, then this section [1.4.2 Communication Channels](#) does not apply and the communication must be given in the manner specified within that section.

1.4.3 RSP Enquiry

RSPs may submit a RSP Enquiry through the enquiry channels supported for the applicable enquiry as outlined in the table below:

Enquiry channels supported	Order Enquiry	Assurance Enquiry	Billing Enquiry
Phone	Y*	Y	Y
Email	N	N	Y
Live chat	Y	Y	N
"Comments" section	N	Y**	N

* **Note:** Phone enquiry channel is not available for Order Enquiry relating to **nbn**[®] Ethernet TC-4.

** **Note:** **nbn** will only respond to the enquiry if the comment contains the prefix "**nbn** Action Required".

Module 2: On-boarding



2.1 In This Module

This module describes the processes and activities that your organisation must undertake to obtain accreditation prior to ordering Products.

These are the On-boarding processes and activities referred to in clause C1 of the [Head Terms](#).

Your organisation must complete all of the On-boarding processes and activities set out in section [2.2 Conduct Initial On-boarding](#) prior to ordering any Product, Product Component or Product Feature.

Your organisation may be required to conduct supplemental On-boarding, for example, where your organisation wishes to order a Product, Product Component or Product Feature for which Interoperability Certification Testing and/or Operational Accreditation Testing have not been performed or when there are significant changes in the **nbn**® Network, Products, Product Components and/or Product Features: see section [2.4 Conduct Supplemental On-boarding Activities](#).

2.1.1 Introduction

The On-boarding processes and activities described in this module will assist to operationally prepare your organisation for interacting with **nbn** in relation to the supply, installation and configuration of Products.

The consultation between **nbn** and your organisation during On-boarding is intended to provide your organisation with a greater understanding of **nbn**'s operational processes.

On-boarding is also intended to assist your organisation to ensure that its systems and proposed RSP Products or technologies are aligned, and compatible with, **nbn**'s systems and Products.

nbn will reasonably assist your organisation in the performance and completion of the On-boarding processes and activities.

Your organisation must complete all of the On-boarding processes and activities at its own cost.

2.1.2 The On-boarding Roadmap

On-boarding consists of a number of stages; each stage is comprised of a sequence of activities.

The following diagram illustrates the stages and activities involved; sections [2.2](#) to [2.4](#) describe each of these in detail:

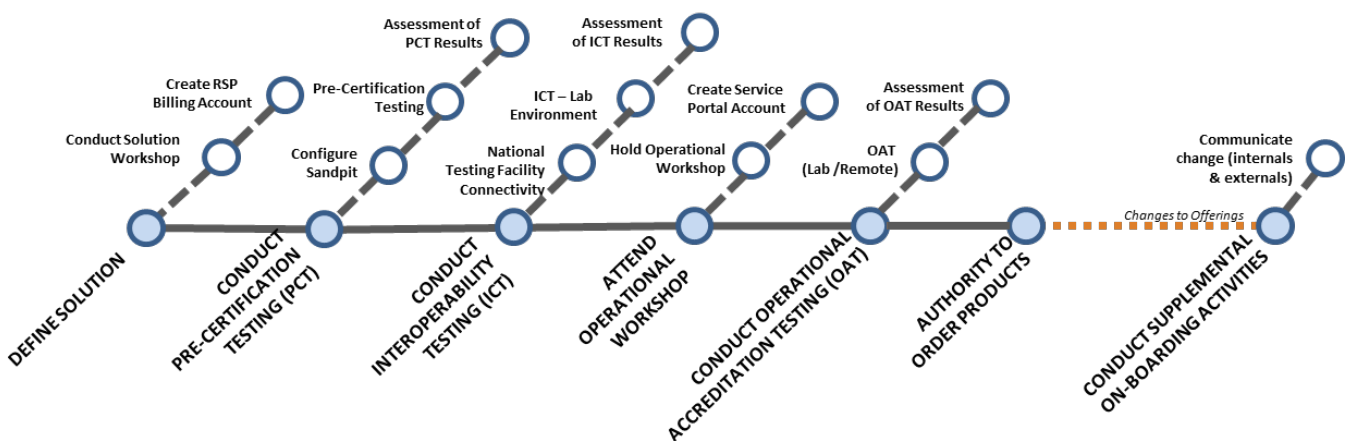

Your organisation must do all of the following (unless otherwise agreed with **nbn**):

- Attend the Solution Workshop prior to conducting Pre-Certification Testing
- Conduct Pre-Certification Testing prior to conducting Interoperability Certification Testing
- Attend the Operational Workshop prior to conducting Operational Accreditation Testing

- Conduct Operational Accreditation Testing prior to being authorised to order Products.

The Operational Workshop must be held after the Solution Workshop, but may be held on the same day.

2.1.3 Workshops and Training

During the On-boarding process, **nbn** may provide workshops and training sessions for your organisation.

The purpose of the workshops and training sessions is to educate your organisation’s Personnel (for example, contact centre and service desk staff) who will be involved in day-to-day transactions between **nbn** and your organisation.



Important: Prior to each workshop or training session, **nbn** will notify your organisation of the type of Personnel (being people who understand your organisation’s business, technical integration, operations and provisioning requirements) that must attend the workshop or training session. Your organisation must ensure that a reasonable number of these Personnel attend the workshop or training session.

2.2 Conduct Initial On-boarding

2.2.1 Define Solution

2.2.1.1 Conduct Solution Workshop

nbn will hold a workshop designed to explain each of the following (Solution Workshop):

- Products
- Interfaces and related integration requirements
- Requirements for the Sandpit
- Requirements for Pre-Certification Testing (PCT) and Interoperability Certification Testing (ICT)
- Other aspects of the On-boarding process, such as the Operational Workshop and Operational Accreditation Testing (OAT)
- How the construction, technology and hardware architecture associated with your organisation’s RSP Network, RSP Platform, RSP Products, systems and services generally need to successfully interact with the **nbn**® Network, **nbn**® Platform and Products.

Following the Solution Workshop, and with **nbn**’s assistance, your organisation must create the following document, which represents the processes and products your organisation must test in order to successfully complete Interoperability Certification Testing:

Document	Description
<i>Solution Brief</i>	<p>High-level document containing information about your organisation’s:</p> <ul style="list-style-type: none"> • Network architecture • Product requirements • Interoperability Certification Testing requirements. <p>Your organisation drafts this document for discussion with, and the approval of, nbn.</p> <p>Your organisation is not required to submit a Product Order Form for B2B Access. Your organisation may request supply of B2B Access by notifying nbn that it is a Product requirement and completing On-boarding for B2B Access.</p>



Important: Both **nbn** and your organisation must finalise the ***Solution Brief*** and your organisation must have appropriate insurance in place (see clause E5 of the [Head Terms](#) and section 3 of the [Service Terms for the Facilities Access Service](#)) before Interoperability Certification Testing can begin.

2.2.1.2 Create an RSP Billing Account

During the Solution Workshop, **nbn** will provide your organisation with a form which your organisation must complete to request that a billing account (**RSP Billing Account**) be created for it (**Billing Account Request Form**).

nbn requires the following information ...	Your organisation must do the following ...
All items as indicated by the fields in the Billing Account Request Form	Send the completed Billing Account Request Form to the nbn [®] Relationship Point of Contact.
The contact details of each Authorised Contact	Add the names and contact details of each Authorised Contact to the Contact Matrix .

After your organisation provides all of the required information and completes all of the activities described above, **nbn** will create the RSP Billing Account for your organisation.

The **nbn**[®] Relationship Point of Contact will notify your organisation as soon as reasonably practicable after **nbn** creates your organisation's RSP Billing Account.

2.2.2 Conduct Pre-Certification Testing

This testing stage consists of the following activities:

Activity	Purpose
Configure Sandpit	Provides your organisation with a safe environment to develop and test technology and systems.
Pre-Certification Testing	Evaluates your organisation's readiness to commence Interoperability Certification Testing.
Assessment of PCT	Determines whether or not your organisation is ready to commence Interoperability Certification Testing.

2.2.2.1 Sandpit Configuration

The [Sandpit Service Description](#) contains details of that environment. Your organisation is required to submit a Product Order Form for the Sandpit. **nbn** will ensure that the Sandpit is configured to allow Pre-Certification Testing to occur.

There are constraints associated with the availability of the Sandpit and the lead times required to provision the service. **nbn** will notify your organisation of the details of these constraints during the Pre-Certification Testing phase.

2.2.2.2 Pre-Certification Testing

nbn will provide your organisation with the Pre-Certification Testing Program.

Your organisation must perform and complete each of the certification tests set out in the Pre-Certification Testing Program. On completion of testing, your organisation will be required to complete a test report demonstrating that you have completed testing requirements.

2.2.2.3 Assessment of PCT

Following the conclusion of Pre-Certification Testing, **nbn** will do each of the following:

- Assess Pre-Certification test report completed by your organisation
- Determine whether or not your organisation has successfully completed the requirements of Pre-Certification Testing
- Prepare the PCT Documentation.

2.2.3 Conduct Interoperability Certification Testing

The purpose of this stage is to ensure that your organisation's systems and technologies will operate correctly with the **nbn**[®] Network and Products.



Important: Your organisation must obtain **nbn**'s approval for the *Solution Brief*, and successfully complete Pre-Certification Testing, before Interoperability Certification Testing can begin.

nbn will provide your organisation with details of the Interoperability Certification Testing required for each relevant Product Testing Module (ICT Program).

Each ICT Program will cover the following:

Activity	Purpose
Ensure connectivity to the National Test Facility	Ensures that your organisation can connect to the National Test Facility to undertake Interoperability Certification Testing.
Interoperability Certification Testing	Evaluates whether your organisation's technology and systems can interoperate effectively with the nbn [®] Network and Products.
Assess Interoperability Certification Testing results	Determines whether or not your organisation's technology and systems can interoperate effectively with the nbn [®] Network and Products.



Note: Your organisation may request a Satellite Test Service from **nbn** during On-boarding in accordance with section 7 of the [nbn[®] Ethernet Product Description](#) by following the process set out in section [8.6 Credits for Satellite Test Services](#).

2.2.3.1 National Test Facility Connectivity

To undertake Interoperability Certification Testing your organisation requires connectivity to the National Test Facility.

The *Access Timetable* specifies the period during which the National Test Facility will be available for use by your organisation.

Your organisation may connect to the National Test Facility by either of the following methods:

Connectivity Method	Description
Your organisation may bring equipment to the National Test Facility itself	<p>If your organisation chooses this connectivity method, your organisation must deliver its equipment to the National Test Facility at its own cost and risk.</p> <p>nbn will do both of the following:</p> <ul style="list-style-type: none"> Install your organisation's equipment (as delivered) in a secured cabinet in the National Test Facility Equipment Room Provide your organisation with a direct connection to that equipment for testing purposes.
nbn can set up a remote connection to your organisation's equipment	<p>If your organisation chooses this connectivity method, nbn will provide a fibre link from the National Test Facility to, and connectivity to an NNI at, the West Melbourne Temporary POI.</p> <p>Your organisation must then connect its test equipment to the NNI (as it would with a normal connection to the Fibre Network) at that site and connect to the National Test Facility via that link.</p>

Note: **nbn** may provide your organisation with additional information related to the National Test Facility from time to time.

2.2.3.2 ICT – Lab Environment

For each relevant Product Testing Module, your organisation must perform and complete each of the certification tests set out in the ICT Program.

Testing Phase Requirements

Your organisation must provide all of the following (including all necessary consents and approvals) for the duration of any Interoperability Certification Testing phase:

- All backhaul between the West Melbourne Temporary POI and your organisation’s facilities (if choosing remote-access connectivity) and RSP Equipment

Note: RSP Equipment includes any additional equipment reasonably requested by **nbn** that is required to conduct Interoperability Certification Testing.

- Connectivity between your organisation’s technology (i.e. the RSP Platform) and the **nbn**[®] Network, through interfaces developed by your organisation
- Permission for **nbn** to use any of your organisation’s RSP Equipment as specified in the ICT Program, so that **nbn** can conduct Interoperability Certification Testing
- Any assistance that is reasonably required by **nbn** to conduct the Interoperability Certification Testing.

Note: This assistance includes your organisation making its technical Personnel available on-site at the National Test Facility, as reasonably requested by **nbn**.

End of Testing: Removal of Equipment and Vacating the National Test Facility

At the end of the period specified in the **Access Timetable**, your organisation must, at its own cost and risk, do all of the following, regardless of whether **nbn** has completed Interoperability Certification Testing:

- Immediately remove all of your organisation’s RSP Equipment from, and vacate, the National Test Facility
- If reasonably requested by **nbn**, remove all backhaul connections used by your organisation in connection with Interoperability Certification Testing from the West Melbourne Temporary POI.

Exception: This does not apply to the extent that **nbn** explicitly directs your organisation to do otherwise.

What happens if Interoperability Certification Testing is not successfully completed during this period?

Your organisation must book a new timeslot to complete Interoperability Certification Testing.

2.2.3.3 Assessment of ICT Results

Following the conclusion of Interoperability Certification Testing, **nbn** will do each of the following:

- Determine whether or not your organisation has successfully completed the requirements of Interoperability Certification Testing
- Prepare the ICT Documentation
- Provide a copy of the ICT Documentation to your organisation.

2.2.4 Attend Operational Workshop

2.2.4.1 Hold Operational Workshop

nbn will hold a workshop, designed to introduce your organisation to working with **nbn** (Operational Workshop). It will include each of the following topics:

- Overview of **nbn**[®] documentation (including this document, the **Contact Matrix** and the **Test & Diagnostic Checklist**)

- Roles and responsibilities for both **nbn** and your organisation
- Activations
- Assurance
- **nbn**® Service Portal
- Billing.

In the journey leading up to the workshop, your organisation will be introduced to a range of documents/resources. The following table describes the documents commonly referred to elsewhere in this document:

Document	Description
WBA Operations Manual	This document, which describes the interactions between your organisation and nbn .
Contact Matrix	<p>When complete, the Contact Matrix sets out contact details for Personnel from both nbn and your organisation, who can be contacted in relation to the interactions described in the WBA.</p> <div style="background-color: #fff9c4; padding: 10px; border: 1px solid #ccc;"> <p> Important: nbn may request certain elements of the Contact Matrix information prior to the Operational Workshop to complete the set-up process for Operational Accreditation Testing. Within 10 Business Days of completing the Operational Workshop, your organisation must do both of the following:</p> <ul style="list-style-type: none"> • Complete the full details of your Personnel who can be contacted in relation to the matters specified in the Contact Matrix • Provide the completed Contact Matrix to nbn. </div> <p>Both nbn and your organisation must ensure that the Contact Matrix contains up-to-date details of their respective Personnel in accordance with clause H1.3 of the Head Terms. Whenever those Personnel or their contact details change, each party must advise the other party of those changes in accordance with section 1.4.1 Maintaining the Contact Matrix.</p>
Test & Diagnostic Checklist	The Test & Diagnostic Checklist will assist your organisation to identify Service Faults prior to reporting them to nbn .

Note: **nbn** will organise the Operational Workshop for a date and time suitable to both your organisation and **nbn**. It may be held either on the same day as the Solution Workshop, or at a later date.

2.2.4.2 Create **nbn**® Service Portal Accounts

Prior to or during the Operational Workshop, **nbn** will provide your organisation with a form to request the creation of **nbn**® Service Portal accounts for your organisation’s Delegated Administrator(s) and Authorised Users (**nbn**® **Service Portal Request Form**).

Your organisation must complete and return the **nbn**® **Service Portal Request Form** to **nbn** within 10 Business Days from the date of original request. Earlier submission of this form will result in your organisation being able to complete Operational Accreditation Testing sooner.

 **Important:** Prior to the workshop **nbn** may request that your organisation provide additional information to configure the **nbn**® Service Portal OAT environment for Operational Accreditation Testing (OAT). It is important for your organisation to provide **nbn** with this information and test your organisation’s access to the environment.

The **nbn**® **Service Portal Request Form** must contain all of the following information:

Intended role	Permitted Personnel	Rights	Required information
Delegated Administrator	Each senior employee of your organisation who will act as an administrator of the nbn [®] Service Portal (each a Delegated Administrator).	All of the following: <ul style="list-style-type: none"> • Activation Rights • Administrator Rights • Appointment Rights • Assurance Rights • Billing Rights • Change Rights • Complaints Rights • Network Element Management Rights • Service Request Rights. 	Each person's: <ul style="list-style-type: none"> • First and last names • Job title • Fixed and mobile phone numbers • Email address • Work postal address • Physical workplace address (<i>if different from the work postal address</i>).
Authorised User	Personnel of your organisation who will require some level of authorised access to the nbn [®] Service Portal (each an Authorised User).	One or more of the following: <ul style="list-style-type: none"> • Activation Rights • Appointment Rights • Assurance Rights • Billing Rights • Change Rights • Complaints Rights • Network Element Management Rights • Service Request Rights. 	Each person's: <ul style="list-style-type: none"> • First and last names • Job title • Fixed and mobile phone numbers • Email address • Work postal address • Physical workplace address (<i>if different from the work postal address</i>) • The specific rights required.

After your organisation has provided this information, **nbn** will create an **nbn**[®] Service Portal account for each Delegated Administrator and Authorised User your organisation has nominated.

 **Important:** Your organisation must ensure that all Delegated Administrator and Authorised User details are accurate and up-to-date at all times by using the External User Administration Portal, and that each Delegated Administrator and Authorised User agrees to, and complies with, the **nbn**[®] EUAP Terms and Conditions.

nbn[®] Service Portal Rights

The following table describes each of the **nbn**[®] Service Portal rights exercisable on behalf of your organisation:

Rights	Description
Activation Rights	The authority to use the sections of the nbn [®] Service Portal associated with the ordering and activation of Product Components and Product Features. Note: There is also read only access to sections of the nbn [®] Service Portal associated with the ordering and activation of Product Components and Product Features.
Administrator Rights	The authority to add or suspend Authorised Users, and to change Authorised User details.
Appointment Rights	The authority to use the sections of the nbn [®] Service Portal specifically associated with viewing or reserving Appointments for Connect Orders or Modify Orders and Trouble Ticket Appointments for the rectification of Service Faults, Performance Incidents and for performing Site Qualification Enquiries. Note: Each Authorised User with either Activation Rights or Assurance Rights will also have access to the equivalent Appointment Rights functionality.
Assurance Rights	The authority to use the sections of the nbn [®] Service Portal associated with Service Fault and Performance Incident reporting, diagnosis, investigation and repair.

Rights	Description
Billing Rights	The authority to use the sections of the nbn [®] Service Portal associated with viewing and downloading invoices and billing data.
Change Rights	The authority to use the sections of the nbn [®] Service Portal associated with Planned Outage activities.
Complaints Rights	Authority to use sections of the nbn [®] Service Portal associated with the raising of complaints on behalf of a Contracted End User.
Network Element Management Rights	The authority to perform specific actions (e.g. order, activate, assure, migrate, etc.) on one or more network elements via the nbn [®] Service Portal. Sample transactions could be: order an NNI, migrate an AVC, create a CVC alias, etc.
Service Request Rights	The authority to use the sections of the nbn [®] Service Portal associated with submitting an enquiry or request to nbn .

2.2.5 Conduct Operational Accreditation Testing (OAT)



Important: Your organisation must have completed the Operational Workshop and any of its prerequisites before OAT can begin.

This testing stage consists of the following activities:

Activity	Purpose
Perform OAT	Evaluates whether your organisation can effectively interact with the nbn [®] Network and systems.
Assessment of OAT Results	Determines whether or not your organisation's technology and systems can interoperate effectively with the nbn [®] Network and systems.

2.2.5.1 Perform OAT

Preparation for OAT

In preparation for OAT, **nbn** will do each of the following in respect of each Product Testing Module:

- Provide your organisation with an OAT Plan
- Confirm with your organisation, the mutually-agreed period during which the test environment will be made available to perform elements of the testing.

Testing Locations and Access Times

OAT will be conducted remotely (at a mutually-agreed time), between **nbn**'s and your organisation's respective facilities, using the OAT environment for the **nbn**[®] Service Portal.

Constraints

For each relevant Product Testing Module, your organisation must perform and complete OAT:

- Via telephone or email (the performance of which **nbn** must be reasonably able to monitor)
- During the mutually-agreed period for the relevant Product Testing Module's **OAT Plan**.

nbn Participation

nbn or its agents may also choose to participate in the performance of any element of OAT.



Important: Any **nbn** participation in OAT does not alter your organisation's obligation to both perform and complete testing.

Interruptions to Testing

If an incident arises during OAT, which **nbn** determines is critical, the **nbn**[®] Personnel coordinating the OAT will, as soon as reasonably practicable, inform your organisation's Personnel performing OAT.



Important: All critical issues must be fixed before your organisation can successfully complete OAT. **nbn** may request your organisation to repeat certain OAT test cases in order to rectify any issues encountered during OAT.

Your organisation must fix any non-critical issues during OAT where reasonably practicable.

2.2.5.2 Assessment of OAT Results

On completion of OAT, **nbn** will do all of the following:

- Determine whether or not your organisation has successfully completed the testing requirements
- Issue an OAT test summary report
- Record any outstanding non-critical issues, and track these issues during the Governance Meetings.

2.3 Authority to Order Products

Upon successful completion of OAT and post testing system readiness activities, **nbn** will confirm your authority to order the Products where you have completed the On-boarding process for that Product.

2.4 Conduct Supplemental On-boarding Activities

Following initial On-boarding, your organisation may wish to order Products, Product Components or Product Features for which Interoperability Certification Testing and/or Operational Accreditation Testing have not been performed.

Before your organisation can place such orders, **nbn** may require your organisation to undergo supplemental On-boarding activities for each Product, Product Component, or Product Feature, as relevant.

2.4.1 Communicate Changes to Offerings

If there are significant changes in the **nbn**[®] Network, Products, Product Components and/or Product Features, **nbn** may require your organisation to take part in supplemental On-boarding activities.

What kinds of changes are considered significant?

Examples include the following (not a comprehensive list):

- **nbn** introduces new Products
- **nbn** introduces variations and enhancements to existing Products
- **nbn** introduces new systems and/or new processes
- **nbn** updates its systems or processes, including by means of any Minor B2B Interface Change or Major B2B Interface Change
- **nbn** wishes to implement a Major Upgrade

nbn will consider the impact of all changes and costs on your organisation and Other RSPs, and notify your organisation if any supplemental On-boarding activities are necessary.

Supplemental On-boarding activities may also be necessary where your organisation wishes to order a Product, Product Component or Product Feature for which Interoperability Certification Testing and/or Operational Accreditation Testing have not been performed.

If **nbn** requires your organisation to complete supplemental On-boarding activities, it will endeavour to bundle multiple changes within a single release (if such changes occur at the same time) to minimise the administrative impact on your organisation.

Your organisation must complete any required supplemental On-boarding activities which **nbn** notifies your organisation of, before your organisation is able to place orders for each relevant Product, Product Component or Product Feature.

2.4.2 Conduct On-boarding for Future Functionality

nbn may allow your organisation to conduct On-boarding for a proposed product, product component or product feature (each a Future Functionality) prior to the date that it is available to be ordered as a Product, Product Component or Product Feature (as applicable), in which case:

- **nbn** will invite your organisation to conduct On-boarding for the Future Functionality
- **nbn** will notify your organisation of the terms and conditions which will apply to **nbn**'s supply of the Future Functionality for the purposes of On-boarding (Future Functionality On-boarding Terms)
- your organisation must comply with the Future Functionality On-boarding Terms
- subject to the Future Functionality On-boarding Terms, this [Module 2](#) will apply to the On-boarding as if references to a Product, Product Component and Product Feature are references to Future Functionality.

Module 3: Physical Access



3.1 In This Module



This Module is concerned with the protection of **nbn**'s and your organisation's information and physical assets in connection with the supply of the Facilities Access Service, including the use of locks and biometric identification systems to limit access to Authorised Persons.

This Module describes the processes, rights and obligations applicable to gaining physical access to Type 1 Facilities and Type 2 Facilities, where this is permitted in connection with **nbn** supplying a Service Element of the Facilities Access Service to your organisation.

During On-boarding, or as a part of a Site Induction Course, your organisation will be provided with information, rules and policies regarding physical access to Type 1 Facilities and Type 2 Facilities.

Refer to the [Service Description for the Facilities Access Service](#) for a description of the differences between a Type 1 Facility and a Type 2 Facility.

3.2 Site Induction

3.2.1 Physical Access Requests

Your organisation may request physical access to Type 1 Facilities and Type 2 Facilities for the purposes outlined in section 10 of the [Service Description for the Facilities Access Service](#).

During On-boarding or as part of a Site Induction Course, and from time to time, **nbn** will outline the processes and procedures relating to physical access, and provide contact details (through the **Contact Matrix**) relating to Physical Access Requests.

Requesting access refers to the process of gaining approval to access Type 1 Facilities and Type 2 Facilities in connection with the supply of relevant Service Elements of the Facilities Access Service.

Subject to the other requirements in the [WBA](#), your organisation's permission to access Type 1 Facilities and Type 2 Facilities will last for 12 months (or a lesser period, where Site Induction Course accreditation is due to expire within 12 months). The period of your organisation's permission to access Type 2 Facilities is also subject to the requirements of the Underlying Facility Provider.

During the period of permitted access, your organisation's Authorised Persons will be issued with Electronic Access Cards, and/or Keys, depending on each site's specific entry requirements.

3.2.2 Site Induction Course

Your organisation must ensure that each of its proposed Authorised Persons has completed a Site Induction Course prior to their first attendance at any Type 1 Facility or Type 2 Facility.

Your organisation must also ensure that each of its proposed Authorised Persons comply with any requests of **nbn** to complete any other required Site Induction Courses or briefings before accessing or continuing to access any Type 1 Facility or Type 2 Facility.

nbn will provide the details of Site Induction Courses (including any associated costs or locations) from time to time.

After a proposed Authorised Person has successfully completed the Site Induction Course, **nbn** will provide that Authorised Person with a unique reference number. Your organisation must include the reference number in each subsequent Physical Access Request for an Authorised Person, including applications for Electronic Access Cards or Keys.

Are there any charges associated with Site Induction Courses?

nbn's Charges for Site Induction Courses (if any) are set out in the [Facilities Access Service Price List](#). Charges levied by Third Party Suppliers are not dealt with under the [WBA](#).

How long does accreditation from a Site Induction Course last?

Accreditation is valid for **2 Years** (or such other period as may be determined by **nbn** or the Underlying Facility Provider and notified to your organisation from time to time) from the date of successful completion of the relevant Site Induction Course.

Your organisation must ensure that its Authorised Persons maintain and renew their Site Induction Course credentials as required.

3.2.3 Electronic Access Cards

3.2.3.1 Single or Multiple Electronic Access Cards?

Each Electronic Access Card will provide an Authorised Person with one of the following, at **nbn**'s discretion:

- Access to a single site (i.e. a single Type 1 Facility or Type 2 Facility), as requested.
- Access to all instances of a single site type (i.e. Type 1 Facilities or Type 2 Facilities), for one State and/or Territory, as requested.



Important: A Type 1 Electronic Access Card will be required for access to electronic key safes in both Type 1 Facilities and Type 2 Facilities. For details on electronic key safes, see section [3.2.4 Physical Key Requests](#).

Note:

- Access to Type 1 Facilities in the Australian Capital Territory is granted as part of access to Type 1 Facilities in New South Wales
- For Type 2 Facilities access, your organisation must request each State and Territory separately.

If any of your organisation's Authorised Persons require access to both Type 1 Facilities and Type 2 Facilities, or to Type 2 Facilities at which they wish to access electronic key safes, they will require at least two Electronic Access Cards: one for Type 1 Facilities and electronic key safes and the other for Type 2 Facilities. For details on electronic key safes, see section [3.2.4 Physical Key Requests](#).

nbn's ability to provide Electronic Access Cards for Type 2 Facilities is subject to availability and receipt of such cards from the Underlying Facility Provider.

Electronic Access Cards and Access in Multiple States

Your organisation can request, or **nbn** may issue at its discretion, an Electronic Access Card that is valid for Type 1 Facilities or Type 2 Facilities in more than one State and/or Territory, for an individual Authorised Person of your organisation.

Following such a request, and subject to eligibility, **nbn** may issue your organisation with a single Electronic Access Card for that Authorised Person, which will be valid for all Type 1 Facilities or Type 2 Facilities in the requested States and/or Territories. Otherwise, that Authorised Person will require multiple cards to cover the requested States and/or Territories.

Note: Your organisation's Authorised Person will still require separate cards for Type 1 Facilities and electronic key safes, and for Type 2 Facilities, if needed.



Important: If the relevant Authorised Person is a sub-contractor working both for your organisation and one or more Other RSPs, they will require one Electronic Access Card for your organisation and a separate Electronic Access Card for each Other RSP.

Before issuing Electronic Access Cards to one person for multiple organisations, **nbn** may in its discretion ask them and each organisation to confirm the person's roles and authorisations, and check the Authorised Person's name, address and date of birth.

3.2.4 Physical Key Requests

3.2.4.1 Type 1 Facilities

Keys may be required to enter relevant parts of Type 1 Facilities and will be securely stored in an electronic key safe accessible by the Authorised Person using their Electronic Access Card(s) in accordance with instructions notified by **nbn** from time to time and by security guards at the relevant Type 1 Facility.

Security guards will require presentation of a valid Electronic Access Card, confirmation of identity, and the Authorised Person's approved Planned Access Request or Emergency Access Request for the related Planned Access or Emergency Access (in accordance with section [3.5 Planned Access or Emergency Access](#)).

3.2.4.2 Type 2 Facilities

In order to gain access to Type 2 Facilities, your organisation will in most cases be issued with an Electronic Access Card and in some cases may require Keys.

During On-boarding or as part of a Site Induction Course, and from time to time, **nbn** may provide your organisation with information regarding the Type 2 Facilities that require Keys.

nbn's ability to provide Keys for Type 2 Facilities is subject to receipt of such Keys from the Underlying Facility Provider.

Your organisation may request Keys for a Type 2 Facility whenever **nbn** supplies your organisation with the relevant Service Elements of the Facilities Access Service which require Physical Access to that Type 2 Facility.

Your organisation may request Keys to more than one Type 2 Facility for an individual Authorised Person.

The Keys to the Equipment Racks supplied to your organisation within Type 2 Facilities will be stored in an electronic key safe accessible by the Authorised Person using a Type 1 Electronic Access Card, which must be used in accordance with instructions notified by **nbn** from time to time.



Important: An Electronic Access Card issued for access to a Type 2 Facility cannot be used to access an electronic key safe in the Type 2 Facility. Your organisation must request, and **nbn** may issue a separate Type 1 Electronic Access Card which may be used to access the electronic key safe.

Electronic key safes which are accessible by your organisation's Authorised Persons may not be available at all Type 2 Facilities. **nbn** will notify your organisation of the Type 2 Facilities at which electronic key safes are accessible by your organisation's Authorised Persons from time to time.

If electronic key safes are not available at a Type 2 Facility, your organisation's Authorised Person must order Keys in accordance with section [3.2.5 Ordering Electronic Access Cards and Keys](#) and may only access your organisation's Equipment Racks by requesting Escorted Physical Access (in accordance with section [3.5.5 Escorted and Unescorted Physical Access](#)).

3.2.5 Ordering Electronic Access Cards and Keys

To order Electronic Access Cards and/or Keys, your organisation must perform all of the following steps:

Steps	Action
1	Complete the Physical Access Request Form accessible on the External User Administration Portal.
2	Ensure that all requests for Electronic Access Cards or Keys are only submitted for Authorised Persons.
3	Submit the completed Physical Access Request Form via the External User Administration Portal.

Note: Your organisation may request up to a maximum of 50 Electronic Access Cards and/or Keys for individuals using a **Physical Access Request Form**. Any requests for additional Electronic Access Cards and/or Keys will require a 'show cause' and **nbn** may elect to issue further Electronic Access Cards and/or Keys if it determines, in its absolute discretion, that your organisation has demonstrated a need for them. **nbn** may elect to charge your organisation for additional Electronic Access Cards and/or Keys as specified in the [Facilities Access Service Price List](#).



Important: Your organisation must ensure that each of your Personnel agrees to, and complies with, the **nbn**[®] EUAP Terms and Conditions when accessing the External User Administration Portal.

nbn will check submitted **Physical Access Request Forms** to ensure that your organisation has validly completed all mandatory fields. **nbn** may contact your organisation to confirm that your organisation's Personnel identified in the **Physical Access Request Form** are Authorised Persons. **nbn** may reject any invalid **Physical Access Request Forms**.

If **nbn** rejects an invalid **Physical Access Request Form**, it will notify your organisation's Operational Point of Contact.

For Type 1 Facilities and Type 2 Facilities in which electronic key safes are available, your organisation does not need to order Keys to the Equipment Racks which **nbn** is supplying to your organisation. After **nbn** begins supplying an Equipment Rack to your organisation, the Keys will be stored in the electronic key safe by **nbn** and your organisation will be notified. Your organisation's Authorised Persons may then access the Keys from the electronic key safe in accordance with instructions notified by **nbn** from time to time.

Note: For Type 2 Facilities – if the Electronic Access Card has not been used for a 6 month period in any given State or Territory, it will be deactivated.

3.2.6 Dispatch and Delivery

nbn will inform your organisation when ordered Electronic Access Cards or Keys are available and/or dispatched.

Both Electronic Access Cards and the instructions to activate them will be made available for collection at a place nominated by **nbn**, or as follows:

- (Electronic Access Cards for Type 1 Facilities) Delivered to any address for Electronic Access Card deliveries nominated by your organisation that is acceptable to **nbn**
- (Electronic Access Cards for Type 2 Facilities) Delivered to your organisation via post to the address provided in the relevant **Physical Access Request Form**.

Provided that the following requirements have been met (as applicable) **nbn** will use reasonable endeavours to provide (or make available) Electronic Access Cards or Keys within 25 Business Days of receiving the **Physical Access Request Form**:

- The **Physical Access Request Form** has been completed correctly
- (In the case of Type 2 Facilities) The Underlying Facility Provider has supplied any necessary Electronic Access Cards or Keys

- (In the case of replacement cards) The requirements of section 3.3.1 Lost, Stolen or Missing Electronic Access Cards and Keys and section 3.3.3 Damaged or Faulty Electronic Access Cards and Keys (as the case requires) are satisfied.

What if ordered Electronic Access Cards / Keys fail to arrive or be made available within the expected time?

For Type 1 Facilities, your organisation should email **nbn** at nbn-siteaccess@nbnco.com.au, providing all relevant details of the order and attaching a copy of the relevant **Physical Access Request Form**.

For Type 2 Facilities, your organisation should email **nbn** at nbn-exchangeaccess@nbn.com.au, providing all relevant details of the order and attaching a copy of the relevant **Physical Access Request Form**.

What if my organisation has other issues relating to an Electronic Access Card or Key request?

Your organisation should contact **nbn**, using the details provided in the **Contact Matrix**.

3.3 Electronic Access Cards and Key Maintenance

When in possession of Electronic Access Cards or Keys (including when Keys are temporarily accessed from an electronic key safe within a Type 1 Facility or Type 2 Facility for use within that facility), your organisation must (and must ensure that each of its Authorised Persons) do all of the following:

- Adopt effective security measures to prevent loss, damage and unauthorised use or access to the Electronic Access Cards and/or Keys
- Ensure there is no unauthorised copying of Keys and Electronic Access Cards
- Provide assistance as requested by **nbn** (or the Underlying Facility Provider in relation to Type 2 Facilities) in ensuring adequate security and safety in the Type 1 Facilities and Type 2 Facilities to which your organisation has Electronic Access Cards and/or Keys
- Immediately return any Electronic Access Cards or Keys to **nbn** or the electronic key safe, as applicable, when your organisation or its Authorised Persons no longer require access to (or are no longer authorised to access) the relevant Type 1 Facility or Type 2 Facility in accordance with the process in section 3.3.7 Returning Electronic Access Cards and Keys
- (Where applicable) ensure that any Key accessed from an electronic key safe at a Type 1 Facility or Type 2 Facility does not leave that facility at any time
- (Where applicable) ensure the security of the electronic key safe from which any Key is accessed.

3.3.1 Lost, Stolen or Missing Electronic Access Cards and Keys

As soon as your organisation becomes aware that an Electronic Access Card or Key has become lost, has been stolen or is missing, your organisation must do both of the following:

- Telephone **nbn** immediately, using the relevant contact details provided during On-boarding or as specified in the **Contact Matrix**
- Log the incident using iSafe.

See section 3.4.4 Health, Safety and Environment Hazard and Incident Notification.

3.3.2 Lost Electronic Access Cards or Keys: Required information

When your organisation contacts **nbn** to notify **nbn** that an Electronic Access Card or Key for a Type 1 Facility or Type 2 Facility has become lost, has been stolen or is missing, your organisation must provide the following information:

- The Electronic Access Card number (located on the Electronic Access Card) or the Key serial number (as applicable)
- The circumstances surrounding the loss, theft or misplacement of the Electronic Access Card(s) and/or Key(s).

In addition to reporting the lost/stolen/missing Electronic Access Card(s) and/or Key(s), your organisation must also request a new Electronic Access Card or Key if a replacement Electronic Access Card or Key is required.

3.3.3 Damaged or Faulty Electronic Access Cards and Keys

When your organisation discovers that an Electronic Access Card or Key for a Type 1 Facility or Type 2 Facility has become faulty or is damaged, your organisation must do each of the following:

- Telephone **nbn** immediately, using the relevant contact details provided during On-boarding or as specified in the **Contact Matrix**
- Log the incident using iSafe
See section [3.4.4 Health, Safety and Environment Hazard and Incident Notification](#)
- For Type 1 or Type 2 Facilities, return (in person or by post) the faulty Electronic Access Card(s) and/or Key(s) (other than Keys accessed from electronic key safes at the facility) to the following address:
Security Administration Team
nbn
Level 13, Tower 5
727 Collins St
Docklands VIC 3008
- Replace the faulty Key(s) (if they are Keys accessed from electronic key safes at the facility) to the electronic key safe
- Request a new Electronic Access Card or Key if a replacement Electronic Access Card or Key is required.

3.3.4 Transferring Use of Electronic Access Cards and Keys

Means of access for Type 1 Facilities are not transferrable.

To transfer use of Electronic Access Cards and/or Keys between Authorised Persons for Type 2 Facilities, your organisation must complete and submit to **nbn**, a **Physical Access Request Form**.

In doing so, your organisation must provide all of the following information (as applicable):

- The Electronic Access Card number (located on the Electronic Access Card)
- The Key serial number
- Details of the Authorised Person from whom the specific Electronic Access Card or Key is being transferred
- Details of the Authorised Person to whom the Electronic Access Card or Key is being transferred.

For Type 2 Facilities, your organisation must then email the form to **nbn** at nbnexchangeaccess@nbn.com.au

Your organisation must ensure that transfer requests of this kind are only submitted for transfers between Authorised Persons. **nbn** will notify your organisation's Operational Point of Contact of the successful transfer once the process is complete.

Note: The transfer of Electronic Access Cards and/or Keys between Authorised Persons for Type 2 Facilities is subject to the approval of the Underlying Facility Provider.

3.3.5 Updating Keys

3.3.5.1 Type 1 Facilities

Physical Keys are kept on-site at Type 1 Facilities. They are provided as appropriate by the facility's security personnel or retrieved from the electronic key safe by Authorised Persons using their Electronic Access Cards, in accordance with section [3.2.4.1 Type 1 Facilities](#).

3.3.5.2 Type 2 Facilities

Whenever **nbn** or the Underlying Facility Provider reconfigures locks in Type 2 Facilities, **nbn** will inform your organisation's Operational Point of Contact of the update and provide your organisation with updated Keys.

Where an electronic key safe is available at a Type 2 Facility as described in section [3.2.4.2 Type 2 Facilities](#), updated Keys to Equipment Racks that are supplied to your organisation within the Type 2 Facility will be stored in the electronic key safe at the Type 2 Facility.

3.3.6 Renewing an Electronic Access Card

Electronic Access Cards for both Type 1 Facilities and Type 2 Facilities have a rolling 12-month expiry period (or a lesser period, where Site Induction Course accreditation is due to expire within 12 months).

Your organisation must monitor and manage the expiry of Electronic Access Cards, and request replacements or renewals as required by your organisation, by completing and submitting a **Physical Access Request Form** through the External User Administration Portal.

Your organisation must lodge renewal requests between 20 and 40 Business Days prior to the expiry date of Electronic Access Cards.

What does my organisation need to verify when renewing Electronic Access Cards?

Your organisation must confirm all of the following:

- That each Authorised Person who will use an Electronic Access Card currently works for your organisation
- That the requested Electronic Access Cards are still required by your organisation
- That the current Electronic Access Cards are still in your organisation's possession.

When the relevant **Physical Access Request Form** is received by **nbn**, **nbn** will confirm each of the following:

- Whether or not the **Physical Access Request Form** submitted by your organisation has been correctly completed
- That the current Electronic Access Card assigned to each Authorised Person is currently valid (i.e. the person's credentials have not expired)
- That the Authorised Person(s) induction accreditation is valid for at least six (6) calendar months from submission of the **Physical Access Request Form**, and that there are no outstanding incidents recorded against them (for example, improperly retained Keys).

If **nbn** determines that the above matters have been satisfied, **nbn** will extend the Electronic Access Card's expiry date to either the Authorised Person's induction expiry date, or for another 12 calendar months, whichever is shorter. **nbn** will also advise your organisation's Operational Point of Contact of the successful renewal.

If **nbn** determines that any of the above matters have not been satisfied or cannot be verified, **nbn** will reject the renewal request, and notify your organisation's Operational Point of Contact.

What if my organisation does not wish to renew Electronic Access Cards?

Your organisation must return the relevant Electronic Access Cards as described in the following section.

3.3.7 Returning Electronic Access Cards and Keys

To return Electronic Access Cards and/or Keys for Type 1 Facilities or Type 2 Facilities that are in the possession of your organisation or any of its Authorised Persons (in the case of Keys, for a Type 2 Facility at which an electronic key safe is not accessible by your organisation's Authorised Persons), your organisation must return (in person or by post) the Electronic Access Card(s) and/or Key(s) to the following address:

For Type 1 or Type 2 Facilities
 Security Administration Team
nbn
 Level 13, Tower 5
 727 Collins St
 Docklands VIC 3008

Where an electronic key safe is accessible by your organisation’s Authorised Persons at a Type 1 Facility or Type 2 Facility, the Keys accessed by your organisation’s Authorised Person must be returned to the electronic key safe by the Authorised Person immediately upon completing work at the relevant Equipment Rack.

Your organisation will be responsible for each of the following:

- Any Key accessed from an electronic key safe and any damage to the electronic key safe after it has been opened by an Electronic Access Card issued to your organisation (including to your organisation’s Authorised Persons) until the electronic key safe is locked
- Any damage, interference or other act affecting an Equipment Rack supplied to your organisation or the RSP Active Equipment in it after the Equipment Rack has been accessed by a Key issued to your organisation’s Authorised Person, until the Equipment Rack is locked
- Any damage, interference or other act that occurs in connection with use of a Key issued to your organisation’s Authorised Person until that Key is returned by the Authorised Person and, in the case of return to an electronic key safe, until the electronic key safe is locked with the returned Key inside.

What does my organisation do with Electronic Access Cards that have been cancelled or are no longer required?

Your organisation must return cancelled or no longer required Electronic Access Cards and/or Keys, by returning them to the address provided (in person or by post).

3.4 Occupational Health, Safety & Environment Requirements

3.4.1 General OH&S and Environment Rules

In addition to complying with the OH&S Laws and Environmental Laws and the matters set out in this section [3.4 Occupational Health, Safety & Environment Requirements](#), your organisation must comply with the following rules:

Rules	
Do	Ensure that your organisation’s Authorised Persons attend any briefings (as required by nbn from time to time) on OH&S (including safe work practices) and the Environment in relation to Type 1 Facilities or Type 2 Facilities.
Do	Ensure that the Site Attendance Logbooks are signed by your organisation’s Authorised Persons.
Do	Ensure that your organisation’s Authorised Persons display your organisation’s identification card while on site at a Type 1 Facility or Type 2 Facility at all times.
Do	Ensure that each of your organisation’s Authorised Persons is familiar with the applicable emergency procedures at each Type 1 Facility or Type 2 Facility and that those Authorised Persons attend to and obey any direction given by nbn or an Underlying Facility Provider in accordance with an emergency management plan and/or by emergency management personnel.
Do	Ensure that your organisation’s Authorised Persons keep all Type 1 Facilities and Type 2 Facilities in a neat and tidy state while in attendance, and: <ul style="list-style-type: none"> • promptly remove all waste, fibre filings and dust to appropriate receptacles once produced • promptly remove any excess equipment of your organisation or its Authorised Persons once it is no longer required • keep exits and paths clear of obstructions and trip hazards at all times.
Do	Follow any procedures of nbn or the Underlying Facility Provider in respect to accessing locations or undertaking works that may be deemed “notifiable” works during the Site Induction Course or as otherwise notified by nbn , including the completion of any forms or the provision of any required information prior to such works commencing. Details will be provided during On-boarding and/or any Site Induction Courses.

Rules	
Do	Co-operate with nbn and Other RSPs in respect of Type 1 Facilities and nbn , the Underlying Facility Provider and Other RSPs in respect of Type 2 Facilities, to the extent that your organisation and its Authorised Persons are accessing such facilities at the same time.
Do	Complete all relevant nationally recognised competence training courses (at your organisation's expense) where any activity within an area at a Type 1 Facility or Type 2 Facility is classified as a confined space.
Do	Complete a risk-assessment and establish the relevant control measures for any activities that require it (as required by any applicable law or otherwise).
Do	Comply with all laws relating to use of the Type 1 Facility or Type 2 Facility, including OH&S Laws and Environmental Laws.
Do	Comply with all reasonable directions of nbn relating to OH&S and the Environment in accessing a Type 1 Facility.
Do	Comply with all reasonable directions of the Underlying Facility Provider relating to OH&S and the Environment in accessing a Type 2 Facility.
Do	Identify hazards and assess the risks in relation to accessing and undertaking your organisation's work within Type 1 Facilities or Type 2 Facilities and implement adequate risk controls in relation to the proposed physical access.
Do	Notify nbn of any inspection, record, finding or notice of a Government Agency that relates to your organisation's use of the Type 1 Facility or Type 2 Facility (including providing a copy of any documentation exchanged with the Government Agency).
Do	Identify and manage through the implementation of appropriate policies and procedures and in accordance with applicable OH&S Laws and Environmental Laws, all relevant risks to OH&S and the Environment arising from, or in relation to, works and activities undertaken when accessing the Type 1 Facility or Type 2 Facility, including without limitation, risks arising from the presence of any confined spaces (for example, fibre pits at Type 1 Facilities).
Do	Notify nbn if your organisation reasonably considers that an action of another person in the Type 1 Facility or Type 2 Facility may threaten the immediate safety of your organisation, its Authorised Persons, nbn or other users of the Type 1 Facility or Type 2 Facility.
Do	Notify nbn of your organisation's intention to, and obtain nbn 's prior written consent to: <ul style="list-style-type: none"> store any goods or substances (including any Hazardous Materials) at a Type 1 Facility or Type 2 Facility change to the nature, composition or volume of any goods or substances (including any Hazardous Materials) stored at a Type 1 Facility or a Type 2 Facility.
Do	Give notice to nbn of any Contamination or Hazardous Materials in any Type 1 Facility or Type 2 Facility.
Do	Follow all directions of nbn as to the notices required in relation to Hazardous Materials where your organisation has obtained that consent, including notifying nbn of any change to the nature, composition or volume of those Hazardous Materials and obtaining consent from nbn .
Do	Comply with all directions of nbn and/or the Underlying Facility Provider where nbn or the Underlying Facility Provider reasonably consider that an action of your organisation or its Authorised Person threaten the immediate safety of persons or plant in the relevant Type 1 Facility or Type 2 Facility.
Do	Submit an AVF if required by section 3.4.2 High Risk Works .
Do not	Store any goods or substances at Type 1 Facilities or Type 2 Facilities while your organisation or its Authorised Persons are not present at the site, unless agreed by nbn in writing.
Do not	Cause or contribute to any Contamination or an Environmental Hazard, at, under or in respect of a Type 1 Facility or a Type 2 Facility, including by way of handling, storing or using Hazardous Materials in a manner likely to give rise to an Environmental Hazard.

Rules	
Do not	Dump Hazardous Materials or cause Hazardous Materials or Contamination to emanate to, or from, the Type 1 Facility or Type 2 Facility.
Do not	Carry out any activities in a Type 1 Facility or Type 2 Facility that: <ul style="list-style-type: none"> • endangers the health or safety of Personnel of the Underlying Facility Provider or any other party • causes a nuisance while accessing a Type 1 Facility or Type 2 Facility • interferes with or prejudices the integrity of, or cause damage to any network, communications within a network, infrastructure or other property or facilities of the Underlying Facility Provider or any other party.

3.4.2 High Risk Works

3.4.2.1 High Risk Work in Type 1 Facilities

Your organisation must submit an AVF to **nbn** via a Service Request when your organisation wants to perform any high risk activities whilst on site at a Type 1 Facility, such as work in confined spaces like the starter pipe/duct, or involves hazardous and/or electrical work. Your organisation must not commence the work until the AVF is approved by **nbn**.

Your organisation must request Escorted Physical Access if it intends to conduct high risk works and must submit the AVF before the associated request for Escorted Physical Access under section [3.5.5.3 Requesting Escorted and Unescorted Physical Access](#).

nbn will endeavour to process the AVF (and subsequently approve or reject it) within three Business Days of your organisation submitting the AVF (if **nbn** requires further information from your organisation this period may be extended). **nbn** will advise your organisation via email if the AVF is approved or rejected, including any reasons for rejection or any conditions of approval (including any agreed variations to the request).

nbn will assess the timing and duration of the access period requested in the AVF, taking into account factors including:

- The type of work and expected duration of that type of work
- Conflicting work for the same period
- Any HSE hazards/risks preventing work in the requested area
- Applicable Embargo Period (see section [5.5.8 Embargo Periods](#))
- Any other conditions specific for the requested site.

When **nbn** is unable to provide access to perform the works identified in the AVF at the time requested by your organisation, **nbn** will contact your organisation's Authorised Person (as specified in the Service Request) to arrange a suitable alternative time for both your organisation and **nbn**, and update the Service Request with the agreed time.

If **nbn** approves the AVF:

- your organisation must perform the works in accordance with any conditions of that approval
- the work to which it relates must be performed within the approved window specified within the AVF.

3.4.2.2 High Risk Works in Type 2 Facilities

If your organisation intends to perform high risk works within Type 2 Facilities, your organisation must notify the Underlying Facility Provider via its notify processes and forms.

3.4.3 Health, Safety and Environment Audits

From time to time, **nbn** may undertake audits of your organisation's health, safety and environmental systems, documents and records to confirm that, as far as reasonably practicable, your organisation is compliant with

relevant workplace health, safety and environment management requirements relating to its continued physical access to Type 1 Facilities or Type 2 Facilities.

How will this occur?

nbn will provide the relevant information regarding the procedures that **nbn** or your organisation must follow when **nbn** proposes to undertake an audit in the manner described above, when it communicates with your organisation's Operational Point of Contact.

If required, **nbn** will report back to the relevant Government Agency in relation to the audit.

3.4.4 Health, Safety and Environment Hazard and Incident Notification

Your organisation must immediately report all of the following that occur within Type 1 Facilities or Type 2 Facilities using iSafe:

- All work and/or health, safety and environment hazards
- All Environmental Hazards, Hazardous Material and Contamination
- All other health and safety incidents.

Your organisation must also report these matters to the **nbn** health, safety and environment contact (as specified in the **Contact Matrix**).

What is iSafe?

iSafe is a software application used by **nbn** to log occupational health, safety and environmental incidents and Environmental Hazards.

During the On-boarding process, **nbn** will supply your organisation with access to *iSafe*.

Your organisation must use *iSafe* to capture all hazards, Environmental Hazards, Hazardous Materials, Contamination or health and safety incidents that occur within Type 1 Facilities and Type 2 Facilities.

Your organisation must provide all required details when submitting any "hazard" or "incident" form required in the iSafe submission procedure, and any resultant investigation and corrective/preventative action plans.

nbn will investigate and work with your organisation to resolve all hazards, including Environmental Hazards, remove all Hazardous Material and Contamination, and address other such health and safety incidents which occur at or in relation to Type 1 Facilities or Type 2 Facilities.

Your organisation must also do each of the following:

- Notify **nbn** if a fault, defect, damage or problem with any of your organisation's equipment causes, or might reasonably cause, damage to the relevant Underlying Facility Provider's infrastructure in a Type 2 Facility, **nbn**® Equipment in a Type 1 Facility or a Type 2 Facility, or pose a risk to the health or safety of any person
- Repair the fault, defect or problem or take other appropriate corrective action, immediately in the case of an Emergency or immediate danger, and as soon as practicable after your organisation becomes aware of it in all other cases
- Notify **nbn** if your organisation becomes aware of a fault, defect, damage, problem or risk to the health or safety of persons or the environment in respect of an Underlying Facility Provider's infrastructure in a Type 2 Facility, or **nbn**® Equipment in a Type 1 Facility or a Type 2 Facility, to which your organisation has been granted access.

3.5 Planned Access or Emergency Access

3.5.1 Site Entry Prerequisites

Before entering a site, your organisation must have satisfied all of the following site entry requirements:

- All Authorised Persons have completed the required Site Induction Courses

See section [3.2 Site Induction](#)

- Your organisation’s Authorised Persons have the correct Electronic Access Cards and/or Keys, as required for the relevant site(s)

See section [3.2 Site Induction](#)

- All relevant on-site entry requirements and responsibilities are met
- Any other site entry requirements of **nbn** or, where relevant, the Underlying Facility Provider, have been met.

3.5.2 Requesting Planned Access or Emergency Access

Whenever your organisation wishes to gain Planned Access or Emergency Access for the Permitted Purpose to a Type 1 Facility or a Type 2 Facility, your organisation must submit a Service Request to **nbn**.

The Service Request must include all relevant site-specific information including as required under section [3.5.5.3 Requesting Escorted and Unescorted Physical Access](#).

3.5.3 Basic Responsibilities

While working at a Type 1 Facility or Type 2 Facility, your organisation must abide by the rules of **nbn** and/or any Underlying Facility Provider for working at that facility, as well as those of a relevant facility owner (if any).

At every site, your organisation must, and must ensure that each of its Authorised Persons, do the following:

Basic Responsibilities	
Do	Ensure that all risks associated with the work undertaken are identified, assessed and controlled.
Do	Be in possession of a valid induction number (from a Site Induction Course), valid for 3 years (or such other period as may be determined by nbn or the Underlying Facility Provider and notified to your organisation from time to time) from the completion date.
Do	Report all health, safety and environment hazards and incidents to the nbn [®] site contact, and log the hazard in iSafe. See section 3.4.4 Health, Safety and Environment Hazard and Incident Notification .
Do	Report any property damage, faults or incidents to the nbn [®] site contact and the relevant manager in your organisation.
Do	Adhere to all site-specific health, safety and environment procedures and signage, including any health, safety and environment and security framework provided to your organisation during On-boarding.
Do	Adhere to all site rules and prohibitions, including in relation to the consuming of food, drugs or alcohol.

3.5.4 Site-specific Requirements

Your organisation must, and must ensure that each of its Authorised Persons, adhere to the following rules at all times:

Site-specific Rules	
Do	Complete all site orientation briefings, if and when required.
Do	Only ever physically enter a Type 1 Facility or Type 2 Facility by way of any entry point identified in the relevant Site Induction Course, or as advised by the Underlying Facility Provider.
Do	Ensure that only Authorised Persons nominated on the Physical Access Request Form submitted by your organisation in relation to the Type 1 Facility or Type 2 Facility gain access to the Type 1 Facility or Type 2 Facility.

Site-specific Rules	
Do	Only ever physically enter a Type 1 Facility or Type 2 Facility as is permitted by the Service Description for the Facilities Access Service .
Do	Follow any procedures of nbn or the Underlying Facility Provider (as applicable) in respect of a notice of departure from Type 1 Facilities or Type 2 Facilities.
Do	Keep all Type 1 Facilities and Type 2 Facilities free from any unnecessary obstruction and promptly clear away any rubbish, excess equipment, fibre filings or dust once produced.
Do	Remove any construction plant and equipment no longer required by your organisation.
Do	Ensure all applicable security arrangements in place prior to entering a Type 1 or Type 2 Facility are in place prior to leaving the Type 1 or Type 2 Facility and, where practical and under the control of an Authorised Person, remain in place while they are at the Type 1 or Type 2 Facility.
Do	Use due care and attention regarding security of the infrastructure and equipment in or forming part of Type 1 Facilities or Type 2 Facilities.
Do	Remove Authorised Persons from any Type 2 Facility to the extent necessary to enable the Underlying Facility Provider to remedy significant faults in its services or address an Emergency.
Do	Remove Authorised Persons from any Type 1 Facility to the extent necessary to enable nbn to remedy significant faults in its services or address an Emergency.
Do	Obtain nbn 's prior written consent to replace, modify, rearrange, or remove your organisation's equipment on rack space in a Type 1 Facility or a Type 2 Facility.
Do	Allow nbn or the Underlying Facility Provider to inspect all works undertaken by your organisation or its agents on all your organisation's equipment in Type 1 Facilities or Type 2 Facilities.
Do	Notify nbn of any breach by your organisation or its Authorised Persons of any requirement in this section, or section 3.4 Occupational Health, Safety & Environment Requirements , as soon as possible and in any case within one Business Day of becoming aware of the breach.
Do	Acknowledge that, as between your organisation and nbn , any Heritage Items discovered by your organisation in a Type 1 Facility or a Type 2 Facility are the property of nbn .
Do Not	Interrupt or interfere with any nbn [®] Equipment or the equipment of Other RSPs, including (but not limited to) generators, heating, ventilation, and air conditioning and fire systems.
Do Not	Erect, install or display any advertising, promotional or similar signage on or in any Type 1 Facility or Type 2 Facility without the prior written agreement of nbn and the Underlying Facility Provider.
Do Not	Damage, disturb or destroy any cultural or Heritage Items in or on Type 1 Facilities or Type 2 Facilities or act in a way which is contrary to any applicable laws relating to any cultural or Heritage Items.
Do Not	Make, or cause to be made, any visual or audio-visual recordings within any relevant POI Site or Aggregation Node Site, including photographs or videos, without the prior written consent of nbn (which may be given or withheld or given with conditions, in nbn 's discretion) or in accordance with sections 7.5(d) and 10.4(d) of the Service Description for the Facilities Access Service - for details on how to request consent to take photographs please refer to the nbn [®] <i>Operations User Guide</i> .

3.5.5 Escorted and Unescorted Physical Access

3.5.5.1 Escorted Physical Access

In accordance with section [3.5.5.3 Requesting Escorted and Unescorted Physical Access](#), your organisation must request Escorted Physical Access when carrying out any work at a Type 1 Facility, except in the cases detailed in section [3.5.5.2 Unescorted Physical Access](#).

Where an AVF is required by section [3.4.2 High Risk Works](#), your organisation must:

- Submit the AVF together with the request for Escorted Physical Access; and

- Ensure that the Authorised Person(s) brings a copy of the approved AVF (or the approved AVF reference number) to the Type 1 Facility on each day of access to undertake the work detailed in the approved AVF. Your organisation must comply with any access conditions specific for the requested site when on site for Escorted Physical Access.

3.5.5.2 Unescorted Physical Access

Except where **nbn** or a relevant Underlying Facility Provider, at its discretion, requires Escorted Physical Access, your organisation may access a Type 1 Facility or Type 2 Facility using Unescorted Physical Access where your organisation has:

- acquired Co-location and:
 - your Authorised Persons need to access an Equipment Rack being supplied by **nbn** to your organisation; and
 - an electronic key safe accessible by your organisation’s Authorised Persons is available at the relevant Type 1 Facility or Type 2 Facility (see section 3.2.4.1 Type 1 Facilities and section 3.2.4.2 Type 2 Facilities); or
- obtained Escorted Physical Access for the Permitted Purpose of an **nbn**® Building Entry Service installation and informs **nbn** that your organisation requires further access for that Permitted Purpose using Unescorted Physical Access.

3.5.5.3 Requesting Escorted and Unescorted Physical Access

Your organisation must request Escorted Physical Access or Unescorted Physical Access for the Permitted Purpose by raising a Service Request using the **nbn**® Service Portal and, in doing so, providing all of the following information:

- The reason for Escorted Physical Access or Unescorted Physical Access (Planned Access or Emergency Access)
- The type of work to be completed
- (Where applicable), the Equipment Rack location including the floor, suite and rack number
- Contact details for the Authorised Person for whom your organisation is requesting access
- The Electronic Access Card number(s) to be used by the Authorised Person for whom your organisation is requesting access
- The POI Site or Aggregation Node Site to which your organisation is requesting access
- Requested start and end time for access
- Any other preferred appointment details
- An approved AVF or the approved AVF reference number (if applicable)
- Any additional matters set out in Additional Requirements and Information below.

Additional Requirements and Information

In addition to the matters set out above, whenever your organisation requests Escorted Physical Access or Unescorted Physical Access, **nbn** and your organisation must comply with the following requirements and provide the following information:

Access Type	Requirements and Information
Planned Access	<p>Escorted Physical Access</p> <ul style="list-style-type: none"> • Your organisation must provide nbn with 5 Business Days’ prior notice of the requested Escorted Physical Access • nbn will then contact your organisation’s Authorised Person (as defined in the Service Request) to confirm the requested time for Escorted Physical Access, and update the Service Request with the confirmed time(s) • When nbn is unable to provide Escorted Physical Access at the requested time, nbn will contact your organisation’s Authorised Person (as specified in the Service Request)

Access Type	Requirements and Information
	<p>to arrange a suitable alternative time for both your organisation and nbn, and update the Service Request with the agreed time</p> <ul style="list-style-type: none"> If relevant, your organisation must permit the Underlying Facility Provider (if it requests) to attend certain works, as described earlier in this section. <p>Unescorted Physical Access (Co-location rack access only)</p> <ul style="list-style-type: none"> Your organisation must provide nbn with the following prior notice of requested Unescorted Physical Access: <ul style="list-style-type: none"> (If your organisation is not required to submit an AVF in accordance with section 3.4.2 High Risk Works) at least 1 Business Day in advance of the required access date provided in the Service Request. (If your organisation has submitted an AVF in accordance with section 3.4.2 High Risk Works in connection with prior Escorted Physical Access and is requesting further Unescorted Physical Access) at least 3 Business Days in advance of the required access date (if nbn requires further information from your organisation, nbn may extend this period). nbn is unable to provide Unescorted Physical Access if an electronic key safe accessible by your organisation's Authorised Persons is not available at the relevant Type 1 Facility or Type 2 Facility. In this case, nbn will contact your organisation's Authorised Person (as specified in the Service Request) to arrange a suitable alternative time for both your organisation and nbn to facilitate Escorted Physical Access, and update the Service Request with the agreed time. <p>Note: Your organisation may request Unescorted Physical Access in connection with the nbn[®] Building Entry Service. See section 3.5.5.2 Unescorted Physical Access.</p>
Emergency Access	<ul style="list-style-type: none"> nbn will endeavour to provide Escorted Physical Access in a timely manner. nbn Personnel will contact your organisation's Authorised Person (as defined in the Service Request) to arrange and agree a suitable time for both your organisation and nbn. If an electronic key safe accessible by your organisation's Authorised Persons is available at a Type 1 Facility or Type 2 Facility (see section 3.2.4.1 Type 1 Facilities and section 3.2.4.2 Type 2 Facilities) your organisation may request Unescorted Physical Access for an Authorised Person. nbn will endeavour to enable Unescorted Physical Access in a timely manner.

3.5.6 Deliveries

If your organisation wishes to make a delivery to a Type 1 Facility or a Type 2 Facility, it must comply with the following rules.

Facility	Rules
Type 1 Facility	<p>Your organisation must provide 24 hours' notice of the delivery either to RSP Support Centre, or to the nbn[®] Operational Point of Contact (as defined in the Contact Matrix).</p> <p>Any person making a delivery to a Type 1 Facility on behalf of your organisation can only access the Facility when under the supervision of one of your organisation's Authorised Persons at all times during the delivery, and must leave the Facility as soon as the delivery has been made.</p> <p>Unless separately agreed with nbn, nbn is not required to accept deliveries on behalf of your organisation.</p>
Type 2 Facility	<p>Any person making a delivery to a Type 2 Facility on behalf of your organisation can only access the Facility when under the supervision of one of your organisation's Authorised Persons at all times during the delivery, and must leave the Facility as soon as the delivery has been made. Unless separately agreed with the Underlying Facility Provider, the Underlying Facility Provider is not required to accept deliveries on behalf of your organisation.</p>

3.6 Breaches of Access Rules and Procedures

nbn will work with your organisation during On-boarding to ensure that your organisation is provided with rules and policies relating to physical access to Type 1 Facilities and Type 2 Facilities.

If **nbn** determines that your organisation and/or its Personnel have breached these rules/policies or the **Access Seeker Undertaking**, **nbn** may do either or both of the following:

- Immediately refuse your organisation access to any Type 1 Facilities and Type 2 Facilities
- Revoke your organisation's existing physical access approvals.

3.6.1 Physical Access Refusal or Revocation

nbn or the Underlying Facility Provider may at any time revoke physical access to, or request your organisation's Authorised Persons to cease work and/or leave a Type 1 Facility or Type 2 Facility immediately, on any of the following bases:

- On the grounds set out in the [Service Description for the Facilities Access Service](#) or the [Service Terms for the Facilities Access Service](#)
- **nbn** reasonably believes that your organisation is in breach of any of its obligations under the [WBA](#) and/or policies as provided to your organisation
- Any Personnel of your organisation commits (or **nbn** reasonably believes that any Personnel of your organisation has committed) any type of security breach, or has engaged in any unlawful act
- Any Personnel of your organisation improperly enters a Type 1 Facility or Type 2 Facility, or does not produce acceptable photographic identification when requested by **nbn** or an Underlying Facility Provider
- Any Personnel of your organisation enters a Type 1 Facility or Type 2 Facility without having completed the Site Induction Course or other relevant course for that facility or the Personnel no longer has valid accreditation for the Site Induction Course or other relevant course.

If **nbn** decides to refuse or revoke physical access to a Type 1 Facility or Type 2 Facility to any of your organisation's Personnel, **nbn** will notify your organisation and provide reasons for the refusal or revocation unless it considers it is inappropriate or unable to do so for privacy, confidentiality or legal reasons.

3.6.2 Compliance Requirements

Your organisation must, and must ensure that each of its Authorised Persons, immediately comply with any direction given by **nbn** or the applicable Underlying Facility Provider, regarding cessation of work or leaving any Type 1 Facility or Type 2 Facility, including any direction given pursuant to an **Access Seeker Undertaking**.

Where **nbn** considers it to be appropriate, **nbn** will work with your organisation to resolve issues relating to immediate physical access refusal to enable your organisation and its Authorised Persons to return to the Type 1 Facility or Type 2 Facility within a reasonable period.

3.7 **nbn**[®] Building Entry Service (Type 1 Facilities only)

This section [3.7 **nbn**[®] Building Entry Service \(Type 1 Facilities only\)](#) does not apply to Type 2 Facilities.

3.7.1 Installation of Lead-in or Backhaul Transmission Cables

Refer to section [4.5.2.7 **nbn**[®] Building Entry Service \(Type 1 Facilities\)](#).

3.7.2 Arranging Physical Access to use the **nbn**[®] Building Entry Service

Your organisation must separately arrange physical access for its Authorised Persons in relation to the **nbn**[®] Building Entry Service, including for each of the following purposes:

- Installing lead-in or backhaul transmission cables pursuant to the **nbn**[®] Building Entry Service
- Observing **nbn**'s performance of Post-Installation Audits and Inspections.

Module 4: Activations



4.1 In This Module







This module describes the processes and interactions that apply to the ordering and provisioning of **nbn**[®] Ethernet (Fibre), **nbn**[®] Ethernet (FTTB), **nbn**[®] Ethernet (FTTN), **nbn**[®] Ethernet (FTTC), **nbn**[®] Ethernet (HFC), **nbn**[®] Ethernet (Wireless) and **nbn**[®] Ethernet (Satellite) Products and some elements of the Facilities Access Service.

4.2 nbn Rollout Forecasts

4.2.1 Rollout Plans

4.2.1.1 Network Rollout Communication Plan

The **nbn**[®] Network is being rolled out in regions (Rollout Regions) according to a range of plans (Rollout Plans).

Network Type	Rollout Region
 	In the case of the Fibre Network, FTTB Network, FTTN Network, FTTC Network and HFC Network, a Rollout Region is typically, but not always, a Serving Area Module (SAM) or new development site.
 	
	In the case of the Wireless Network, a Rollout Region is typically, but not always, a Wireless Serving Area (WSA).
	In the case of the Satellite Network, a Rollout Region is a State or Territory except where specified otherwise by nbn .

nbn will endeavour to make information available to your organisation (via **nbn**'s Website) relating to the rollout of the **nbn**[®] Network.

For information about the available Rollout Plans, refer to the latest **nbn**[®] *Access Seeker Communications Pack*, available from **nbn**'s Website.

4.2.1.2 Material Changes to Connectivity Serving Areas (CSAs)

nbn will provide at least 6 months prior written notice to your organisation of a material change to the characteristics of a CSA associated (at the time of the change) with an Established POI (specified in a POI Rollout Plan) where your organisation has active services which are likely to be impacted by that change.

For the purposes of this section, a 'material change to the characteristics of a CSA' includes any of the following:

- A change to the POI Site or Aggregation Node Site with which the CSA is associated
- A material change to the geographic boundaries of the CSA
- A change of more than +/- 10% to the approximate number of Premises served by the CSA (on completion).

However, a 'material change to the characteristics of a CSA' does not include the following:

- A change to the name of the CSA
- A change to the identifier for the CSA
- A change in relation to a CSA associated with a Temporary POI
- A change regarding the POI Site or Aggregation Node Site in respect of which a CSA is associated, where the existing POI is a Temporary POI and the new POI is an Established POI.

4.2.1.3 nbn Rollout Forecasts

Each month, **nbn** will publish an **nbn Rollout Forecast**. It provides forecasts of the Rollout Regions that **nbn** expects to deliver each month for 12 months. The first of the 12 months included in the forecast is the month after publication. Each **nbn Rollout Forecast** is the Lock-in **nbn** Forecast for the 4th month covered in that **nbn Rollout Forecast**.

Example: The following table provides an example of **nbn** Rollout Forecast periods

Forecast	Month nbn Rollout Forecast published	Forecast Period	nbn Rollout Forecast is the Lock-in nbn Forecast for the month of...
1 st	July 2017	August 2017 to July 2018	November 2017
2 nd	August 2017	September 2017 to August 2018	December 2017

4.2.2 One-off Address Queries

Your organisation can query address information contained in either the **Proposed Footprint List** or the **Historical Footprint List** by raising a Service Request (**Address Query**).

4.2.2.1 Interactions: Submit an Address Query

The following diagram illustrates the interactions between your organisation and **nbn** that can arise from the submission of an Address Query.

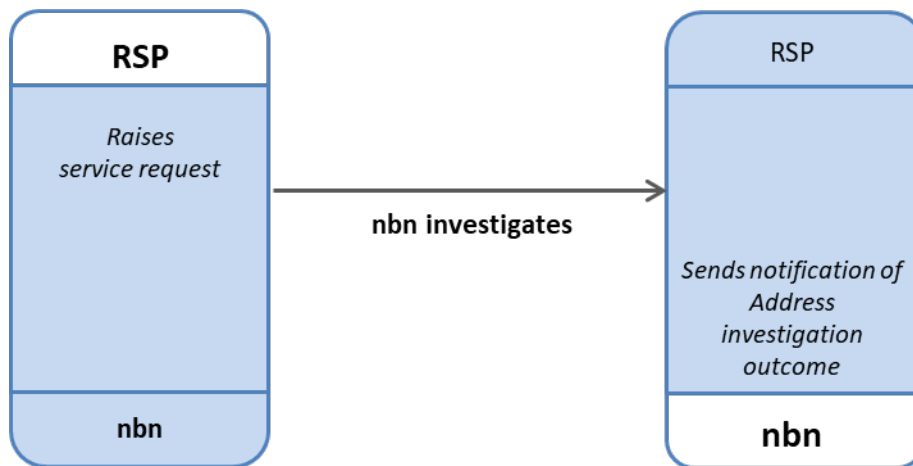

Description

The following table describes the interactions between your organisation and **nbn** that can arise from the submission of an Address Query.

Who	Activity
Your organisation...	<p>Reviews the Historical Footprint List and the Proposed Footprint List, and depending on what it finds, does one of the following:</p> <ul style="list-style-type: none"> (If the address is not present in the Historical Footprint List or the Proposed Footprint List) Reviews the Historical Rollout Region List to confirm whether or not the SAM or WSA or Rollout Region for that area is ready for service. <p>If the SAM or WSA or Rollout Region is not present in the Historical Rollout Region List, the address is not Serviceable, and no further action will be taken</p>

Who	Activity
	<ul style="list-style-type: none"> (If the address is present in any of the Historical Footprint List, the Proposed Footprint List or the Historical Rollout Region List) Raises a Service Request.
nbn...	<p>(Following investigation of address discrepancies identified by your organisation through this process) Notifies your organisation (via the nbn[®] Service Portal) of any necessary changes to the Historical Footprint List and the Proposed Footprint List (or any other documents) arising from that investigation, and closes the Service Request.</p>

4.2.2.2 Service Request: Information Required

If your organisation is required to raise a Service Request (as described in section 4.2.2.1 [Interactions: Submit an Address Query](#) above), your organisation must include all of the following information:

- (If the address is considered incorrect), the existing original address
- The requested correct address
- The missing address
- Additional information (if applicable for the relevant network).

4.3 Site Qualification

4.3.1 Site Qualification Enquiries

nbn will provide, from both the **nbn**[®] Service Portal and B2B Access, tools designed to enable your organisation to determine whether a particular premises or Non-Addressable Object is Serviceable at a given point in time (Site Qualification Enquiry).

If a Site Qualification Enquiry indicates that a premises or Non-Addressable Object is Serviceable, the **nbn**[®] Service Portal or B2B Access (as applicable) will return applicable information, including:

- The Service Class of the Premises or Non-Addressable Object and, for **nbn**[®] Ethernet (FTTB), **nbn**[®] Ethernet (FTTN), and **nbn**[®] Ethernet (FTTC), the Service Class of the relevant **nbn**[®] Copper Pair
- The Products that are available for the Premises or Non-Addressable Object and whether any Product Feature(s) are subject to supply limitations for the Premises or Non-Addressable Object
- Whether there is a Booked Appointment, or other existing planned installation date, relating to the Premises or Non-Addressable Object including in respect to an NTD and FTTC-NCD or a Power Supply Unit
- Whether an alternative access technology is available or, for the **nbn**[®] Service Portal only, planned to be made available at the Premises (e.g. through a Fibre Connect Connection)
- Where available, whether the Charge applicable to New Development Locations under the [nbn[®] Ethernet Price List](#) will apply to the location
- If a Site Qualification Enquiry indicates that a Premises is, or may be, located within the footprint of the Satellite Network, additional information returned will include the Service Level Region of the Premises, indicative dish size for the outdoor unit of the Satellite NTD, whether or not the Premises has existing satellite equipment installed in connection with the Interim Satellite Service, and whether the Premises exists within an Australian External Territory
- Any additional information (if applicable for the relevant network), including (where available) any Estimated Speed
- (For **nbn**[®] Ethernet (FTTN)) if Voiceband Continuity is not available at the location
- (Where available), the Line Status (in response to a Site Qualification Enquiry submitted in respect to a single location within the footprint of the FTTB Network*, FTTN Network or FTTC Network)
- (For **nbn**[®] Ethernet (Fibre)) the type of F-NTD(s) installed, the number of available UNI-D ports on the F-NTD(s) and the available bandwidth of the F-NTD(s) installed at the Premises.

*In certain circumstances this data may be available for the FTTB Network, but only on a limited basis and subject to availability.



Important: Provision, access, use and disclosure of FNN/ULL Data (including Service Type and Line Status) is governed by section 11 of the [Service Terms for the nbn® Platform Interfacing Service](#). **nbn** may take remedial action for breach of those terms by your organisation, Downstream Service Provider or Contracted End User in accordance with the [Service Terms for the nbn® Platform Interfacing Service](#), which may include suspension of access to the Site Qualification System, Site Qualification Information and/or FNN/ULL Data.

nbn will not provide your organisation with any FNN for a Premises or other location.



Important: **nbn** may change which of the access technologies that form part of the **nbn**® Network will be used to serve a Premises from time to time. Notwithstanding that a Site Qualification Enquiry may indicate that an address is served by a particular network, **nbn**'s acceptance of an order is conditional until **nbn** confirms which network will be used to serve that Premises. **nbn** may make a field site visit to confirm which network will be available at the relevant Premises.



Important: If a Premises has been Serviceable from a Temporary POI, then on and from the date that **nbn** will accept orders for that Premises to be served by an Established POI, **nbn** will update the **Historical Rollout Region List** to include details of:

- Both the Established POI CSA and Temporary POI CSA associated with that Premises; and
- The date from which your organisation may place a Temporary POI Migration Order to migrate Ordered Products supplied to that Premises from the Temporary POI CSA to the Established POI CSA.

After **nbn** updates the Historical Rollout Region List to show the association between a Premises and both an Established POI CSA and Temporary POI CSA, but prior to the Block-Out Period commencing in respect of the Temporary POI CSA, a Site Qualification Enquiry performed in respect of a Premises or a Non-Addressable Object via either the **nbn**® Service Portal or B2B Access will return the name associated Established POI CSA.

During this period, your organisation may place a Connect Order in respect of a Premises associated with the Temporary POI CSA and the Established POI CSA in accordance with section 4.5.6 [Temporary POI Migration Orders](#).

Once the Block-Out Period commences in respect of a Temporary POI CSA, **nbn** will permanently remove that Temporary POI CSA from the Historical Rollout Region List for that Rollout Region. See section 4.5.6 [Temporary POI Migration Orders](#) for Connect Orders which your organisation may place in respect of Premises affected by a Block-Out Period during and after the Block-Out Period.

If **nbn** determines that the premises is not Serviceable or may be served by a network forming part of the **nbn**® Network that is different to the network shown in response to a Site Qualification Enquiry, **nbn** will do each of the following:

- Cancel any orders for **nbn** to supply **nbn**® Ethernet in respect of that premises
- Update the **nbn**® Service Portal and B2B Access (as applicable) to indicate that the premises is not Serviceable or to correct the details of the network which is available at the premises
- Update the **Historical Footprint List** to indicate that the premises is not Serviceable or to correct the details of the network which is available at the premises.



Important: For **nbn**® Ethernet (Wireless), if **nbn** determines (including following a site survey) that the premises is unable to achieve the ordered PIR (or, in the case of Wireless Plus, the relevant Information Rate in section 3.8(c) of the [nbn® Ethernet Product Description](#)) at least once per 24 hour period, it may:

- cancel any orders for **nbn** to supply the relevant **nbn**® Ethernet (Wireless) Ordered Product in respect of that premises; and
- update the **nbn**® Service Portal and B2B Access (as applicable) to indicate that the relevant bandwidth profile is not available at the premises.

nbn may further update the **nbn**® Service Portal, B2B Access and **Historical Footprint List** if required by subsequent investigations (e.g. if a premises has been re-categorised as being eligible for **nbn**® Ethernet

(Satellite), but a subsequent field survey finds that it does not have the line-of-sight to an **nbn** satellite required in relation to **nbn**® Ethernet (Satellite).

Note: If a Site Qualification Enquiry indicates that a premises is not Serviceable and returns a 'Planned' or 'Scheduled' target date, the **nbn**® Service Portal or B2B Access (as applicable) will not return any further information in respect of the premises and no further information is available.

As **nbn** expands the **nbn**® Network to serve new Premises, **nbn** will introduce new addresses into the system.

Note: **nbn** will also provide your organisation with the new or updated addresses in the *Historical Footprint List*.

4.3.1.1 Address Enquiry

If your organisation cannot locate a premises in a search using the **nbn**® Service Portal, B2B Access, or in the *Historical Footprint List* but believes the premises is Serviceable, your organisation may raise a Service Request via the **nbn**® Service Portal or B2B Access to request that **nbn** investigates the premises by conducting an Address Enquiry.



If a premises is within the footprint of the Satellite Network, your organisation must perform a Site Qualification Enquiry using the premises' latitude and longitude before raising a Service Request to request that **nbn** conduct an Address Enquiry.

How does my organisation request an investigation?

Through the **nbn**® Platform Interfacing Service (i.e. either the **nbn**® Service Portal or B2B Access).

nbn will perform the investigation. Depending on the result of that investigation, **nbn** will determine and communicate the following information to your organisation:

Investigation result	Consequence
Address is not valid	Your organisation cannot place an order for the premises.
Address is valid and Serviceable	nbn will provide your organisation with the valid nbn ® Location ID and the Service Class for that Premises.
Address is not Serviceable	nbn will update the Site Qualification Enquiries system and the <i>Historical Footprint List</i> to indicate that the premises is not Serviceable.

If your organisation is not satisfied with the information that **nbn** provides in response to an Address Enquiry, your organisation may escalate the matter to **nbn** via your organisation's Operational Point of Contact.

4.3.1.2 Enhanced Site Qualification – service transition

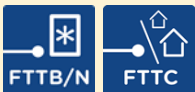

Enhanced Site Qualification Enquiries can only be submitted in respect to a single location which is Serviceable by **nbn**® Ethernet (FTTB), **nbn**® Ethernet (FTTN) or **nbn**® Ethernet (FTTC).

Your organisation must only submit an Enhanced Site Qualification Enquiry where your organisation has Customer Authority.



Important: Provision, access, use and disclosure of FNN/ULL Data is governed by section 11 of the [Service Terms for the nbn® Platform Interfacing Service](#). **nbn** may take remedial action for breach of those terms by RSP, Downstream Service Provider or Contracted End User in accordance with the [Service Terms for the nbn® Platform Interfacing Service](#), which may include suspension of access to the Site Qualification System, Site Qualification Information and/or FNN/ULL Data.

nbn will not provide your organisation with any FNN for a Premises or other location.

Enhanced Site Qualification Enquiry details

Subject to section 8 and 11 of the [Service Terms for the nbn® Platform Interfacing Service](#), your organisation may submit the following information in an Enhanced Site Qualification Enquiry via the **nbn**® Service Portal or B2B Access:

- The FNN or ULL ID for a Premises or other location; and/or
- A Customer Authority Date to **nbn** that is not more than 45 days before the date of the Enhanced Site Qualification request.



Important: **nbn** will not process a Transition Order (with or without Voiceband Continuity) that does not contain an accurate FNN or ULL ID, where required, for the **nbn**® Copper Pair ID to be transitioned.

Exception: **nbn** will process the Transition Order without your organisation submitting a valid FNN or ULL ID where:

- there is only one ULLS supplied to the Premises, or
- the Transition Order is a valid Connect Outstanding Transition Order.

Your organisation must ensure that all other details required by the Product Order Form for the Transition Order are accurate.

If your organisation cannot identify the relevant FNN or ULL ID, your organisation:

- may order the **nbn**® Ethernet Product as a new connection. In this case, the new connection may be a Subsequent Installation – see section [4.5.2 Connect Orders](#); or
- may submit a Connect Outstanding Transition Order where relevant;

Voiceband Continuity will not be available in either of the above cases

Enhanced Site Qualification Enquiry submitted with FNN/ULL ID

The results of this Enhanced Site Qualification Enquiry will comprise a list of **nbn**® Copper Pair IDs that are available for the relevant Premises or other location, together with the following (where available):

- A 'Yes' or 'No' flag is provided against an **nbn**® Copper Pair ID on the list (Whether the FNN or ULL ID submitted does/does not correspond to the **nbn**® Copper Pair ID)
- Service Type (FNN, ULL, Special Service Flag)
Note: Voiceband Continuity cannot be ordered on an **nbn**® Copper Pair with a Special Service Flag (see section [4.5.2.4 Voiceband Continuity \(optional\)](#))
- Line Status
- Last Active Date
- Where applicable, ULL IDs for any existing active ULLS supplied to the location
- Where available from the FNN/ULL Database, the FNN/ULL Provider ID.

Note: In certain circumstances this data may be available for the FTTB Network, but only on a limited basis and subject to availability.



Important: Where the Line Status of an **nbn**® Copper Pair is inactive, no results will be returned except for the Line Status and Last Active Date.

Enhanced Site Qualification Enquiry submitted with no FNN/ULL ID

The results of this Enhanced Site Qualification Enquiry will comprise a list of **nbn**[®] Copper Pair IDs that are available for the relevant Premises or other location, together with each of the applicable results for the Enhanced Site Qualification submitted with an FNN or ULL ID (where available).

Exception: A 'Yes' or 'No' flag will not be provided against an **nbn**[®] Copper Pair ID on the list.

Note: In certain circumstances this data may be available for the FTTB Network, but only on a limited basis and subject to availability.



Important: Where the Line Status of an **nbn**[®] Copper Pair is inactive, no results will be returned except for the Line Status and Last Active Date.

4.3.1.3 Enhanced Site Qualification Enquiries - Service Transfer Order

Where your organisation wishes to place a Service Transfer Order, your organisation may submit an Enhanced Site Qualification Enquiry to identify the existing **nbn**[®] Ethernet Product supplied to a Premises, which will be the subject of the Service Transfer Order. An Enhanced Site Qualification Enquiry can only be submitted in respect of a single location which is Serviceable.

Your organisation may only submit an Enhanced Site Qualification Enquiry via the **nbn**[®] Service Portal or B2B Access in respect of a Service Transfer Order if:

- an existing service which relies on an **nbn**[®] Ethernet Product as an input is supplied to the relevant location;
- your organisation is the Gaining RSP in respect of the existing service;
- your organisation submits a Customer Authority Date in respect of that existing service which is not more than 45 days before the date of the Enhanced Site Qualification Enquiry (and not future dated); and
- one active EPID Code is required to be nominated and displayed against each used data port on the Enhanced Site Qualification and on the loss notification.

The results of an Enhanced Site Qualification Enquiry in respect of a Service Transfer Order will comprise a list of services supplied by **nbn** in respect of the relevant Premises or other location, any linkages between UNI-V and UNI-D Ports, the EPID of the Losing RSP and, if your organisation has included an AVC ID in the Enhanced Site Qualification Enquiry, confirmation of whether the AVC ID corresponds to an Ordered Product supplied to an Other RSP at that Premises.



Important: Your organisation may order an **nbn**[®] Ethernet Ordered Product as a new connection if it cannot identify the relevant existing service for a Service Transfer Order. The new connection may be a Subsequent Installation - see section [4.5.2 Connect Orders](#).

If your organisation is unable to successfully match the AVC ID to facilitate placement of a Service Transfer Order, it is recommended to ensure you have obtained the correct address and AVC ID before raising a Service Request to **nbn** for further investigation.

4.3.1.4 NTD Shortfall

Where a Premises displays as Service Class 24 on Site Qualification but UNI ports are not available on the existing HFC-NTD or the HFC-NTD is missing, the Premises will be treated as either:

- Service Class 23 Premises (see definition of "Service Class 23" in the Dictionary); or
- Service Class 22 or 23 Premises, in the event that a Subsequent Installation of an NTD is ordered (see section [4.6.5 Subsequent Installations of NTDs](#)).

4.3.2 Historical Footprint List

Each week, **nbn** will provide your organisation with access to a Historical Footprint List.

nbn will provide the Historical Footprint List to your organisation's Operational Point of Contact as specified in the **Contact Matrix**.

Note: The **Historical Footprint List** will not list each Centralised Deployment location within a Multi-Premises Site.

Can my organisation use Historical Footprint Lists in any way it chooses?

No: Historical Footprint Lists remain the Confidential Information of **nbn**.

4.3.2.1 Service Classes

The Service Class of a Premises describes its state of readiness. The Service Class of a Non-Addressable Object describes the state of readiness of the associated Centralised Deployment. The various Service Classes are each defined in the [Dictionary](#).



For **nbn**® Ethernet (FTTN) and **nbn**® Ethernet (FTTC), the Service Class of the Premises is derived from the highest Service Class of any existing **nbn**® Copper Pairs used to serve the Premises.

Can the Service Class change?

Yes: **nbn** can change the Service Class of a Premises or Non-Addressable Object or in respect of an **nbn**® Copper Pair. The new Service Class applies immediately. **nbn** may change the network forming part of the **nbn**® Network that is used to serve a Premises (including where your organisation is serving a Non-Addressable Object in a Premises), and the corresponding Service Class of that Premises or Non-Addressable Object, and any **nbn**® Copper Pairs used to serve that Premises, after it has included that Premises or Non-Addressable Object in a Proposed Footprint List or Historic Footprint List. If **nbn** changes the network serving the Premises or Non-Addressable Object, in the case of an in-flight order that has not passed its Point of No Return **nbn** will provide a Cancelled Notification to your organisation.

4.3.2.2 Facilities Access Service enquiries

If requested, **nbn** will tell your organisation the following information about the type of Aggregation Node Site located at the Established POI at which the Facilities Access Service is supplied:

- The Established POI has an Incorporated Aggregation Node Site (Type 1 Facility or Type 2 Facility)
- The Established POI has an Annexed Aggregation Node Site (Type 2 Facilities only).

4.3.2.3 Centralised Deployment Site enquiries



This section applies to **nbn**® Ethernet (Fibre) and **nbn**® Ethernet (HFC).

nbn may conduct a Centralised Deployment at a Multi-Premises Site to allow your organisation to supply RSP Products (or support the supply of Downstream Products) to Non-Addressable Objects.

To assist your organisation to supply RSP Products (or support the supply of Downstream Products) to Non-Addressable Objects, **nbn** will identify:

- each Centralised Deployment location
- each NTD at a Centralised Deployment location

- each Non-Addressable Object which **nbn** has identified in the Multi-Premises Site to which your organisation may wish to supply an RSP Product (or support the supply of a Downstream Product).

nbn will assign a Service Class to each Non-Addressable Object to assist your organisation to understand the activities which **nbn** will need to conduct to complete a Centralised Deployment to support your organisation to supply RSP Products (or support the supply of Downstream Products) to the Non-Addressable Object.



Important: **nbn**'s assignment of a Service Class to a Non-Addressable Object does not mean that **nbn** will supply **nbn**[®] Ethernet to that Non-Addressable Object. **nbn** will only supply **nbn**[®] Ethernet to the UNI on an NTD installed in a Centralised Deployment location associated with the Non-Addressable Object.

If **nbn** has installed an NTD in a Multi-Premises Site, section [4.6.5 Subsequent Installations of NTDs](#) will apply to the Installation of each subsequent NTD at the Multi-Premises Site, regardless of whether each NTD is used in connection with a different Non-Addressable Object in the Multi-Premises Site.

Your organisation must perform a Site Qualification Enquiry in relation to the Non-Addressable Object through B2B Access or the **nbn**[®] Service Portal, and not the Centralised Deployment location.

If your organisation performs a Site Qualification Enquiry for:

- the Centralised Deployment location (contrary to the obligation above), the Service Class will always be Service Class 0
- the Non-Addressable Object, the appropriate Service Class is returned (e.g. Service Class 0, Service Class 1, Service Class 2 or Service Class 3).

4.4 Products

4.4.1 Product Components: Ordering Sequence

Prerequisite: Your organisation will require physical access to an Established POI for certain Infrastructure Components (e.g. **nbn**[®] Building Entry Service, ODF Termination, Co-location and Cross Connects) before your organisation can order certain Product Components.

Before starting any order, your organisation must be certified for physical access to the relevant POI. See [Module 3: Physical Access](#).

Note: If your organisation intends to order a V-NNI, your organisation:

- does not need to be certified for physical access prior to starting an order; and
- appoints the relevant NNI Link RSP as your agent for the purpose of physical access to the relevant POI.

Note: For details associated to NNI Link and V-NNI – refer to section [4.5.8 NNI Link and V-NNI](#).

There may be significant lead times between your organisation placing an order for an Infrastructure Component or a Connectivity Component and **nbn** commencing supply of that Infrastructure Component or Connectivity Component, as applicable.



Important: **nbn** is not responsible for any delays in supplying Access Components to your organisation by reason of a failure by your organisation to take account of these lead times, which is an RSP Event for the purposes of the [WBA](#).

High-level Summary

The following diagram and description outline the high-level ordering sequence to which your organisation and **nbn** must adhere:

Note: If your organisation intends to order a V-NNI, a number of these activities will be undertaken by the relevant NNI Link RSP as agent on your organisation's behalf.

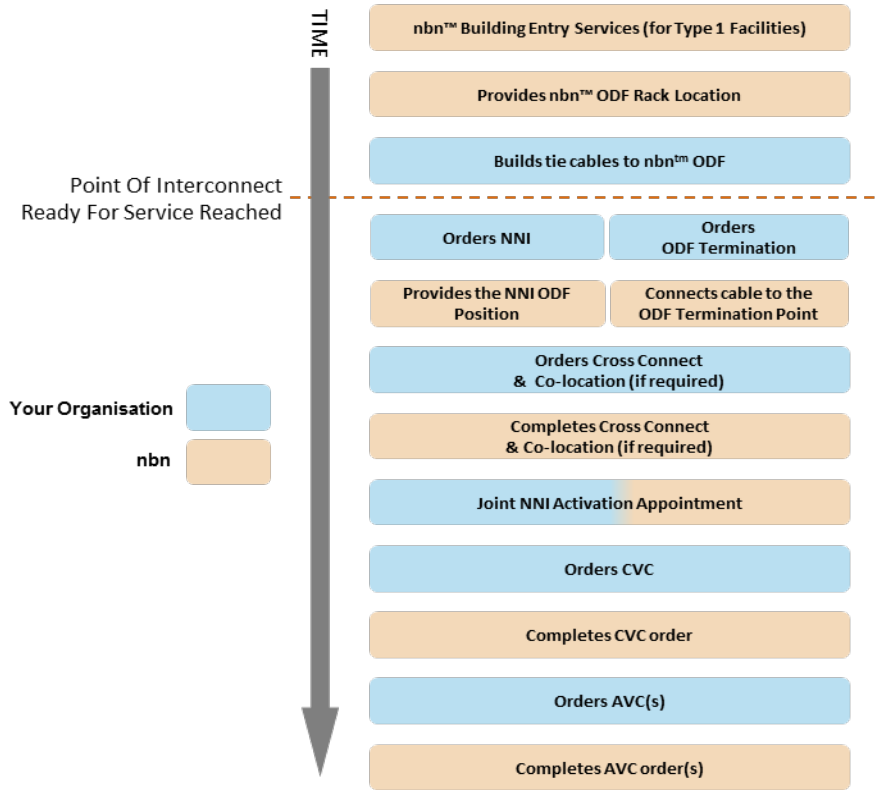

Detailed description

The steps comprising that process, and the associated activities **nbn** and your organisation must perform in relation to each step, are defined in the table below.

Who	Activity
nbn...	<p>(Approximately 2 months before the POI is ready for service) Provides your organisation with the physical rack location of the nbn® ODF. This specifies the floor number, suite and rack number where your organisation will install their backhaul.</p> <p>! Important: (For Type 2 Facilities only) Your organisation requires this information before commencing work with the Underlying Facility Provider.</p> <p>! Important: Your organisation should be aware that nbn may, (or may authorise others), to move or change the designated rack locations of the ODF Termination Point.</p>
Your organisation...	<p>Works with nbn and the Underlying Facility Provider (for Type 2 Facilities) to install backhaul cables above the ODF Termination Point. (If required) Orders the nbn® Building Entry Service for Type 1 Facilities.</p>
Your organisation...	<p>Orders the NNI.</p>

Who	Activity
Your organisation...	Orders ODF Termination. Note: The NNI and ODF Termination are dependent on each other, but are ordered separately. nbn matches up the orders after your organisation submits them.
nbn...	<i>(On acceptance of the NNI order)</i> Provides your organisation with specific details of the NNI's position on the nbn ® ODF.
nbn ...	Attends the POI Site and terminates your organisation's backhaul cables.
Your organisation...	<i>(After the ODF Termination Point is in place and the NNI position is known)</i> Orders a Cross Connect. This Product Component joins together the ODF Termination Point and the NNI.
nbn...	Attends the site and completes fibre patching between the ODF Termination Point and the NNI (the Cross Connection).
nbn...	Activates the NNI. On activation, the status of the NNI order advances to Complete.
Your organisation...	Orders a CVC.
nbn...	Completes the CVC order.
Your organisation...	<i>(When nbn completes the CVC order)</i> Orders AVC/UNI for each Premises.
nbn...	Completes the AVC/UNI order.

Does this mean that for each AVC/UNI, my organisation must place an order for each/all of the other Product Components of **nbn**® Ethernet as well?

No. The above diagram illustrates the sequence in which to order and connect Product Components; not the quantities. Your organisation will (for example) order multiple AVCs to connect to a single CVC, and multiple CVCs to connect to a single NNI. For a detailed description, refer to the [nbn® Ethernet Product Description](#) contained in the [nbn® Ethernet Product Module](#).



Important: For **nbn**® Ethernet (Satellite), if your organisation places an order for a Service Element for a Facilities Access Service, an NNI or a CVC through the **nbn**® Service Portal or B2B Access, your organisation must select the specific attributes detailed in the **nbn**® *Operations User Guide*.

4.5 Orders

4.5.1 About Orders

4.5.1.1 Ordering Product Components

Your organisation can order all Product Components of **nbn**® Ethernet and the Facilities Access Service through the **nbn**® Service Portal.

Note: If your organisation has B2B Access, some Product Components can also be ordered through that interface.

**Important:**

- If **nbn** is unable to obtain lawful access to Premises in order to perform all necessary Installation activities in connection with an order for a Product, or a Professional Wiring Service, **nbn** may update the Order Status to **Pending** until such time as such access is obtained or the Order Status is otherwise changed.
- If **nbn** is unable to obtain lawful access to Common Property in order to perform all necessary Installation activities in connection with an order for a Product, **nbn** may update the Order Status to **Held** until such time as such access is obtained or the Order Status is otherwise changed.
- Your organisation must obtain FTTB/FTTN Installation Consents or FTTC Installation Consents in accordance with section 5 of the [nbn[®] Ethernet Product Terms](#).
- Your organisation is responsible for communicating to the Contracted End User that an existing **nbn[®]** Ethernet (FTTC) Ordered Product to a Premises will experience a temporary service interruption during the performance of any of the following activities:
 - Installation
 - Activation
 - Relocations; and
 - Any activities reasonably incidental to installation, activation and relocation affecting other services (including another Ordered Product or another Carriage Service or Content Service supplied by a retail service provider or any third party) using the same PCD or HFC Lead-in Cable as the existing Ordered Product.



Important: There are a number of circumstances in which **nbn** may place an order into a **Pending** status (see section [4.5.1.6 Order Status Life-cycle](#)) including where your organisation fails to provide safe and timely access to a Premises of Contracted End Users. In the case of a Centralised Deployment at a Multi-Premises Site, **nbn** may request that your organisation procure safe and timely access to multiple areas within the Multi-Premises Site and may place a related Order into a **Pending** status until your organisation does so.

There are also a number of circumstances in which **nbn** may place an order into a **Held** status (see section [4.5.1.6 Order Status Life-cycle](#)) including where **nbn** cannot obtain safe and timely access to property. In the case of a Centralised Deployment at a Multi-Premises Site, if **nbn** attempts to procure its own access to any area within the Multi-Premises Site (e.g. to Common Property) and cannot obtain access in a safe and timely manner, **nbn** may place a related Order into a **Held** status until it can do so.



Important: If **nbn** is unable to obtain lawful access to Premises, including because your organisation fails to obtain all necessary consents in accordance with section 6 of the [nbn[®] Ethernet Product Terms](#), in order for **nbn** to perform all necessary Installation activities (including, where relevant, to de-install and remove any existing satellite equipment) in connection with an order for **nbn[®]** Ethernet (Satellite), **nbn** may update the Order Status to **Pending** until such time as such access is obtained or the Order Status is otherwise changed.

**Important:**

- If **nbn** is unable to obtain lawful access to Premises in order to perform all necessary Installation activities in connection with an order for a Product, **nbn** may update the Order Status to **Pending** until such time as such access is obtained or the Order Status is otherwise changed.
- If **nbn** is unable to obtain lawful access to Common Property in order to perform all necessary Installation activities in connection with an order for a Product, **nbn** may update the Order Status to **Held** until such time as such access is obtained or the Order Status is otherwise changed.
- Your organisation must obtain HFC Installation Consents (as applicable) in accordance with section 7 of the [nbn[®] Ethernet Product Terms](#).

- Your organisation is responsible for communicating to the Contracted End User that an existing **nbn**[®] Ethernet (HFC) Ordered Product to a Premises will experience a temporary service interruption during the performance of any of the following activities:
 - Installation
 - Activation
 - Relocations; and
 - Any activities reasonably incidental to installation, activation and relocation affecting other services (including another Ordered Product or another Carriage Service or Content Service supplied by a retail service provider or any third party) using the same PCD or HFC Lead-in Cable as the existing Ordered Product.



Important:



Your organisation is responsible for communicating to the Contracted End User that an existing **nbn**[®] Ethernet (FTTN), **nbn**[®] Ethernet (FTTC) or **nbn**[®] Ethernet (HFC) Ordered Product to a Premises may experience a service interruption during an Installation related to an **nbn**[®] Ethernet (Fibre) Ordered Product (e.g. where **nbn** performs pull through activities in respect of an existing Lead-In Cable).



Important: Your organisation is responsible for communicating to your affected Contracted End User that an existing **nbn**[®] Ethernet (Fibre) Ordered Product supplied to a Premises will experience a temporary service interruption during the performance of an NTD Replace.

Order Types

The following table outlines the three types of order:

Order Type	Description
Connect Order	A request for the installation and/or configuration of a Product Component.
Modify Order	A request for modifications to an existing installed/configured Product Component.
Disconnect Order	A request to disconnect an existing installed/configured Product Component.

Your organisation can place the following order types for each of the following Product Components:

Product Component	Order Type	Order via ...
nbn [®] Building Entry Service	<ul style="list-style-type: none"> • Connect Order • Disconnect Order 	<ul style="list-style-type: none"> • nbn[®] Service Portal
ODF Termination	<ul style="list-style-type: none"> • Connect Order • Disconnect Order 	<ul style="list-style-type: none"> • nbn[®] Service Portal
Co-location	<ul style="list-style-type: none"> • Connect Order • Disconnect Order • Modify Order 	<ul style="list-style-type: none"> • nbn[®] Service Portal
Cross Connect	<ul style="list-style-type: none"> • Connect Order • Disconnect Order • Modify Order 	<ul style="list-style-type: none"> • nbn[®] Service Portal
Network-Network Interface (NNI)	<ul style="list-style-type: none"> • Connect Order • Disconnect Order • Modify Order 	<ul style="list-style-type: none"> • nbn[®] Service Portal • B2B Access

Product Component	Order Type	Order via ...
Connectivity Virtual Circuit (CVC)	<ul style="list-style-type: none"> Connect Order Disconnect Order Modify Order 	<ul style="list-style-type: none"> nbn[®] Service Portal B2B Access
Access Virtual Circuit (AVC) and User Network Interface (UNI)	<ul style="list-style-type: none"> Connect Order Disconnect Order Modify Order 	<ul style="list-style-type: none"> nbn[®] Service Portal B2B Access

Note: Your organisation will only be able to place a Modify Order to migrate a Premises from a Temporary POI to an Established POI via the **nbn**[®] Service Portal. Such orders will not be available via B2B Access.

Related document: [nbn[®] Ethernet Price List](#) and [Facilities Access Service Price List](#).

4.5.1.2 Amending Orders

Your organisation can amend an order at any time before the Point of No Return by placing an amendment request through the **nbn**[®] Service Portal or B2B Access (Amendment Order).



Important:

In respect of a Connect Order for an End User Installation – FTTC (**nbn** Dispatched), FTTC (RSP Dispatched) or an RSP Professional Installation – FTTC;

- your organisation may only amend the order and request an **nbn** Professional Installation - FTTC (and an Appointment) 12 hours from receiving an Order Acknowledgement and when the order is at "**In Progress – Pending**"; and
- prior to amending the Connect Order, End User troubleshooting has been completed.

4.5.1.3 Cancelling Orders

Your organisation can cancel an order at any time before the Point of No Return by placing a cancellation request through the **nbn**[®] Service Portal or B2B Access.

4.5.1.4 Point of No Return

When an order reaches its Point of No Return, your organisation cannot amend or cancel it. The following table indicates the Order Status (as shown in **nbn**[®] systems) for each order type that represents its Point of No Return:

Product Component	Component type	Point of No Return
<ul style="list-style-type: none"> nbn[®] Building Entry Service ODF Termination Co-location Cross Connect 	Infrastructure Component	Order Status = In Progress .
<ul style="list-style-type: none"> Connectivity Virtual Circuit (CVC) Network-Network Interface (NNI) 	Connectivity Component	<p>(If the order is not an NNI Upsize Migration or NNI Diversity Upgrade):</p> <p>Order Status = Complete.</p> <p>(If the order is an NNI Upsize Migration or NNI Diversity Upgrade):</p> <p>Order Status = In Progress on or around the scheduled start date/time.</p>

Product Component	Component type	Point of No Return
<ul style="list-style-type: none"> Access Virtual Circuit (AVC) and User Network Interface (UNI) for nbn[®] Ethernet (Fibre), nbn[®] Ethernet (FTTN), nbn[®] Ethernet (FTTB) and nbn[®] Ethernet (FTTC), nbn[®] Ethernet (Wireless), nbn[®] Ethernet (HFC) and nbn[®] Ethernet (Satellite) except in an Isolated Area or Limited Access Area 	Access Component	(If the order is not a Service Transfer Order): 24 hours before the Actual Appointment, or where no Appointment is required, when Order Status = Complete . (If the order is a Service Transfer Order): Order Status = In Progress and the Accepted notification has been sent to the RSP.
<ul style="list-style-type: none"> Access Virtual Circuit (AVC) and User Network Interface (UNI) in an Isolated Area or Limited Access Area 	Access Component	48 hours before the Actual Appointment.

4.5.1.5 Order Enquiries

In-flight Orders only

Your organisation may submit an Order Enquiry using the applicable RSP Enquiry channels described in section 1.4.3 RSP Enquiry.

Transactional Escalation of an Order Enquiry

If **nbn** has not responded to your organisation's Order Enquiry within the times outlined in the following table, your organisation may submit a Transactional Escalation, via a Service Request from the **nbn**[®] Service Portal or B2B Access:

Order Status	Elapsed time since Order Enquiry
Held order	48 hours
All others	24 hours

Management Escalation of an Order Enquiry

If **nbn** has not responded to your organisation's Transactional Escalation request within the times outlined in the following table, your organisation may submit a Management Escalation:

Order Status	Elapsed time since Transactional Escalation
Held order	48 hours
All others	24 hours

To submit a Management Escalation, refer to the **Management Escalation Matrix** (part of the **Contact Matrix**) for the details of your organisation's first level contact and engagement criteria.

4.5.1.6 Order Status Life-cycle

The following diagram illustrates the life-cycle of an order including the different Order Status states that may apply:

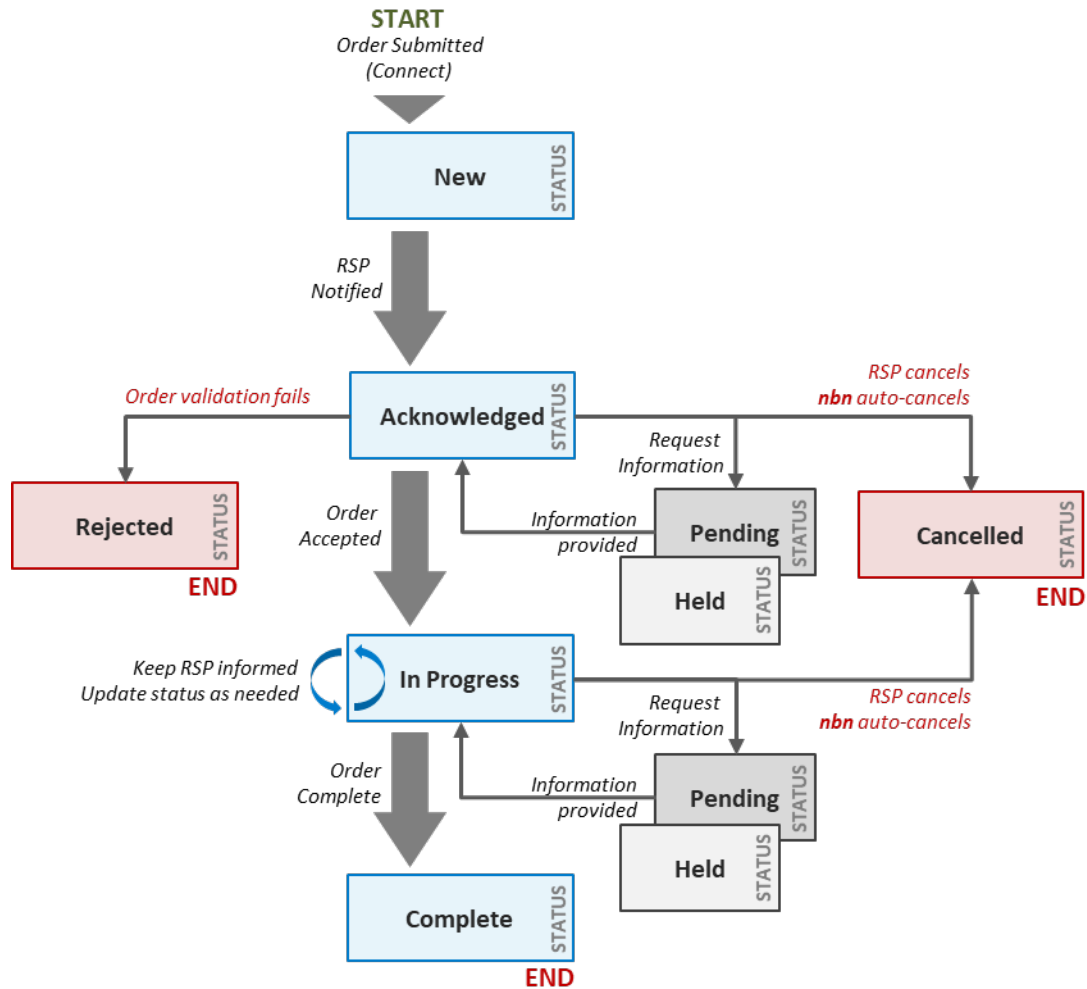

Order Status: Descriptions

The following table defines the different Order Status (as illustrated by reference to a Connect Order) states that apply to an order, the Product Components to which they apply and the related activities which must be performed by **nbn** or your organisation in those circumstances.

These activities must be performed once the relevant event set out in the table occurs.

Note: Further information about orders for the **nbn**® Building Entry Service is set out in section 4.5.2.7 **nbn**® Building Entry Service (Type 1 Facilities).

Exception: The Order Status states in the following table apply for Temporary POI Migration Orders, except in the case of CVC or bulk AVC migration orders which will have an additional Order Status state of 'Scheduled'. See section 4.5.6 Temporary POI Migration Orders.

Order Status	Affected Product Component types	Related event & activities
New	<ul style="list-style-type: none"> Infrastructure Component Connectivity Component Access Component 	<p>Event</p> <p>Your organisation has placed the order with nbn</p> <p>Activities</p> <p>The order awaits validation by nbn</p>
Acknowledged	<ul style="list-style-type: none"> Infrastructure Component Connectivity Component 	<p>Event</p>

Order Status	Affected Product Component types	Related event & activities
	<ul style="list-style-type: none"> Access Component 	<p>Order received by nbn</p> <p>Activities</p> <ul style="list-style-type: none"> nbn validates the order nbn allocates a unique Order ID nbn assigns a Product Instance ID to the Ordered Product Component (If nbn accepts the order as valid) nbn will commence order fulfilment
In Progress	<ul style="list-style-type: none"> Infrastructure Component Connectivity Component Access Component 	<p>Event</p> <p>No issues encountered</p> <p>Your organisation has complied with all requirements of the WBA necessary to progress the order</p> <p>Installation/activation process commences.</p> <p>Activities</p> <ul style="list-style-type: none"> nbn updates the order status to In Progress nbn sends an Order Accepted Notification to your organisation. <p>This includes order details as described in the section below headed Order Accepted Notifications: Additional Product Component Information.</p>
Held (Acknowledged – Held or In Progress – Held)	<ul style="list-style-type: none"> Infrastructure Component Connectivity Component Access Component 	<p>Event</p> <p>There is a delay in nbn processing the order</p> <p>Activities</p> <ul style="list-style-type: none"> nbn updates the order status to Acknowledged – Held or In Progress – Held (as applicable) nbn sends notification of the status change to your organisation. <p>When resolved:</p> <ul style="list-style-type: none"> nbn updates the order comments and changes status as relevant nbn sends notification of the status change to your organisation.
Complete	<ul style="list-style-type: none"> Infrastructure Component Connectivity Component 	<p>Event</p> <p>nbn successfully connects and activates the Ordered Product Component. nbn commences charging in accordance with clause B1.2 of the Head Terms.</p> <p>Activities</p> <ul style="list-style-type: none"> nbn updates the order status to Complete The related Product Instance ID becomes active nbn sends a Completed Notification to your organisation.
Complete	<ul style="list-style-type: none"> Access Component 	<p>Event</p> <p>nbn successfully installs (where required), then connects and activates the Ordered Product Component. nbn commences charging in accordance with clause B1.2 of the Head Terms.</p> <p>Activities</p> <ul style="list-style-type: none"> nbn updates the order status to Complete The related Product Instance ID becomes active nbn sends a Completed Notification to your organisation.

Order Status	Affected Product Component types	Related event & activities
Rejected	<ul style="list-style-type: none"> • Infrastructure Component • Connectivity Component • Access Component 	<p>Event</p> <p>nbn reasonably determines that the order is invalid, due to one or more of the following circumstances:</p> <ul style="list-style-type: none"> • Your organisation has not complied with Product-specific ordering terms or requirements • The order is not submitted in accordance with the requirements, restrictions or other processes set out in the WBA, including this WBA Operations Manual • A Stop Sell Period currently applies to the ordered Product, Product Component, Product Feature or access technology and the order is not a Transition-out Modify Order or Disconnect Order • The order fails nbn's feasibility and design and/or configuration phase • The order includes invalid information, including (at the time of order) an invalid FNN or ULL ID • The order does not include a valid Customer Authority (where required) • In respect of a Service Transfer Order (other than a Non-Infrastructure Type Transfer) submitted on or after 18 May 2025, your organisation has not provided the AVC ID or last 5 digits of the AVC ID of the Ordered Product supplied to the Other Losing RSP that is the subject of the Service Transfer • In respect of a Service Transfer Order requesting a Service Transfer, the order has been placed in respect of a Premises flagged as receiving a service and requires transfer validation action to be taken by your organisation under the Communications Alliance Industry Guideline NBN Access Transfer – Transfer Validation Trial or NBN Access Transfer Industry Code C647:2023 • The order fails to meet the Business Rules in respect of the relevant Product Component • <i>(For orders in respect of nbn[®] Ethernet (Satellite))</i> nbn has determined that your organisation has placed orders or requested Appointments in a way that has adversely impacted Other RSPs or nbn installation activities • <i>(For orders in respect of nbn[®] Ethernet (Satellite))</i> nbn has determined that the Premises is a Medium/Large Business Premises that is not currently receiving a Sky Muster[®] Service • There are no available UNI ports or the order is for an AVC TC-4 Product Component that will result in the total aggregate upstream PIR or downstream PIR for all AVC TC-4 ordered products supplied to an NTD at that Premises exceeding the available bandwidth of that NTD as determined by nbn and any one of the following applies: <ul style="list-style-type: none"> • your organisation has not requested an NTD Add or NTD Replace for the relevant order • <i>(for orders submitted via nbn[®] Service Portal)</i> your organisation has not reserved an

Order Status	Affected Product Component types	Related event & activities
		<p>Appointment for an NTD Add or NTD Replace and your organisation has not opted for an End User Installation – HFC or RSP Professional Installation – HFC (if relevant).</p> <ul style="list-style-type: none"> • your organisation has placed the order as a Service Transfer Order • nbn is not obliged to perform a Subsequent Installation to fulfil that order and does not exercise its discretion to perform a Subsequent Installation • there is an in-flight Connect Order or Modify Order in respect of the relevant Premises for which nbn will perform an NTD Replace. • There is an in-flight Connect Order associated with a Fibre Connect Connection in respect of the relevant Premises • The order is otherwise defective. <p>Activities</p> <ul style="list-style-type: none"> • nbn updates the order status to Rejected • nbn sends a Rejected Notification to your organisation • nbn provides your organisation with reasons for rejecting the order (located in the order’s “comments” field).
<p>Pending (Acknowledged – Pending or In Progress - Pending)</p>	<ul style="list-style-type: none"> • Infrastructure Component • Connectivity Component • Access Component 	<p>Event</p> <p>One of the following:</p> <ul style="list-style-type: none"> • nbn considers that it has insufficient information to fulfil an order • Your organisation has not taken all actions necessary to progress the order or comply with the WBA. • <i>(For orders in respect of nbn[®] Ethernet (Satellite))</i> nbn cannot make contact with the Appointment Representative within five Business Days of your organisation submitting an order with a valid Appointment ID. <p>Activities</p> <ul style="list-style-type: none"> • nbn updates the order status to Acknowledged – Pending or In Progress - Pending (as applicable) • nbn sends a Pending notification to your organisation • nbn includes details of the information that your organisation must provide to nbn, or action that your organisation must take, for successful validation. <p>Your organisation:</p> <ul style="list-style-type: none"> • Must provide information and/or take the requested action within 20 Business Days of receiving the Pending notification or, in the case of nbn[®] Ethernet (Satellite) orders, within 5 Business Days (unless otherwise provided for in this WBA Operations Manual or agreed with nbn) • May submit an Order Enquiry during this time, this may include a request for an extension with supporting details.

Order Status	Affected Product Component types	Related event & activities
		<p>The order remains Pending until nbn considers that it has the required information to proceed and/or your organisation has taken the requested action and/or your organisation or nbn Cancels or Rejects the order.</p> <p>For orders submitted via B2B Access: nbn may send reminder notifications via B2B Access (configured to occur every 30 days) as long as the order has a status of Pending.</p> <p>Time extensions to supply information</p> <div style="background-color: #ffffcc; padding: 5px;">  <p>Important: The time extensions process outlined below does not apply for nbn[®] Ethernet (FTTC) where the order is In Progress Pending due to waiting for AVC Traffic flow – refer to section 4.6.7.4 No Traffic Flow by end of Pending Period.</p> </div> <p>If your organisation has taken all necessary steps to provide the required information and/or take the requested action in the required time, it can request an extension.</p> <p>nbn may grant an extension of up to 30 Business Days from the date of receipt of the request.</p> <p>Note: Your organisation may request a time extension up to 2 times to extend the requested action for up to 30 Business Days at a time.</p> <p>Your organisation:</p> <ul style="list-style-type: none"> • May submit an Order Enquiry during this time • May request such extensions up to 2 times. <p>Cancelling or Rejecting a Pending order</p> <p>nbn may cancel or reject a Pending Order if your organisation does not take the requested action or provide the required information within 30 Business Days of receiving the Pending notification or, in the case of nbn[®] Ethernet (Satellite) orders, within 5 Business Days, or within a longer period if permitted by nbn.</p>
<p>Cancelled</p>	<ul style="list-style-type: none"> • Infrastructure Component • Access Component 	<p>Event</p> <p>Occurs in the following situations:</p> <ul style="list-style-type: none"> • The order is not submitted in accordance with the method outlined in this Operations Manual or the WBA • Your organisation submits a 'cancel' order request for an in-flight order that has not passed its Point of No Return • A Stop Sell Period currently applies to the ordered Product, Product Component, Product Feature or access technology and the order is not a Transition-out Modify Order or Disconnect Order • Your organisation fails to provide the requested information, or take any required action, to allow a Pending order to proceed, within the timeframes as set out in the WBA

Order Status	Affected Product Component types	Related event & activities
		<ul style="list-style-type: none"> In respect to an in-flight order that has not passed its Point of No Return, where nbn determines that the premises is not Serviceable or is served by a network forming part of the nbn[®] Network that is different to the network shown in response to a Site Qualification Enquiry In respect to an in-flight order that has not passed its Point of No Return, nbn is aware, or reasonably considers, that your organisation has not obtained an FTTB/FTTN Installation Consent, FTTC Installation Consent, F-NTD Installation Consent or an HFC Installation Consent After the time of submitting a Transition Order, it is found your organisation provided an incorrect FNN or ULL ID (where required) nbn is aware, or reasonably considers, that your organisation does not have a valid Customer Authority (where required) <i>(For orders in respect of nbn[®] Ethernet (Satellite))</i> An order has been Pending on at least two occasions as a result of nbn being unable to make contact with the Appointment Representative to schedule an Actual Appointment (including where your organisation has provided incorrect contact details for the Appointment Representative when reserving the Appointment). <i>(For orders in respect of nbn[®] Ethernet (Satellite))</i> nbn has determined that the Premises is a Medium/Large Business Premises that is not currently receiving a Sky Muster[®] Service. <p>Activities</p> <ul style="list-style-type: none"> nbn updates the order status to Cancelled nbn sends a Cancelled Notification to your organisation.

Order Accepted Notifications: Additional Product Component Information

Once an order has been **Acknowledged** by **nbn**, the order is validated and an Order Accepted Notification will be sent to your organisation. The Order Accepted Notification will include the following information about your organisation’s order for the following Product Components:

Product Component ordered	Information supplied in the Order Accepted Notification
nbn [®] Building Entry Service	<ul style="list-style-type: none"> Order ID Product Instance ID Service ID (one Service ID per entry point) Duct ID (one Duct ID per duct).
ODF Termination	<ul style="list-style-type: none"> Order ID Product Instance ID Service ID (for multiple trays: one Service ID per tray) Tray ID(s) Port ID(s).

Product Component ordered	Information supplied in the Order Accepted Notification
Co-location	<ul style="list-style-type: none"> Order ID Product Instance ID Service ID (for multiple racks: one Service ID per rack) Rack ID(s) Rack details Tray ID(s).
Cross Connect	<ul style="list-style-type: none"> Order ID Product Instance ID Service ID(s) (one Service ID per Cross Connect).
NNI	<ul style="list-style-type: none"> Order ID Product Instance ID NNI Group ID NNI Bearer ID(s) ODF allocation(s).
CVC	<ul style="list-style-type: none"> Order ID Product Instance ID CVC ID S-TAG value confirmation/assignment.
AVC UNI 	<ul style="list-style-type: none"> Order ID Product Instance ID UNI ID(s) Service ID(s) C-Tag value confirmation/assignment Other information applicable to the relevant network forming part of the nbn[®] Network.
AVC UNI 	<ul style="list-style-type: none"> Order ID Product Instance ID UNI ID(s) Service ID(s) C-Tag value confirmation/assignment Port ID Dish size Mount type TRIA type ISS/NSS flag.

4.5.1.7 Priority Assistance Connection Orders

See the [nbn[®] Ethernet Product Description](#), [nbn[®] Ethernet Service Levels Schedule](#) and [nbn[®] Ethernet Product Terms](#) for information on Priority Assistance Connections.











Important: Your organisation must have satisfied **nbn** that your organisation supplies Downstream Priority Assistance Services prior to submitting any Priority Assistance Transactions.

If your organisation proposes to use **nbn**[®] Ethernet as an input into the supply of a Downstream Priority Assistance Service, then your organisation must place an order in accordance with the following table.

Please note: **nbn**[®] Ethernet (Wireless) and **nbn**[®] Ethernet (Satellite) must not be used as inputs into the supply of Downstream Priority Assistance Services.



Important: When submitting an order for a Service Class 34 **nbn**® Copper Pair, your organisation must confirm with the Contracted End User that there is a FTTC-NCD in the Premises. If no FTTC-NCD is present then **nbn** cannot process this as a Priority Assistance Connection order and our Standard or Accelerated Service Level as applicable will apply.

Technology	Service Class	Inactive Premises	Connect Order for the Access Components
 FIBRE	SC1, SC2	N	Standard Connection
		Y	Standard Connection or Accelerated Connection
 FIBRE	SC3	N	Priority Assistance Connection
			Standard Connection or Priority Assistance Connection*
 FTTN	SC11	N	Standard Connection
		Y	Standard Connection or Accelerated Connection
 FTTB/N	SC12	N	Standard Connection
		Y	Standard Connection or Accelerated Connection
 FTTB/N	SC13	N	Priority Assistance Connection
 HFC	SC21, SC22, SC23	N	Standard Connection
		Y	Standard Connection or Accelerated Connection
 HFC	SC24	N	Priority Assistance Connection
 FTTC	SC31, SC32, SC32, SC33	N	Standard Connection
		Y	Standard Connection or Accelerated Connection
 FTTC	SC34	N	Priority Assistance Connection



Important: Your organisation will be provided a cautionary message in the **nbn**® Service Portal, at the time that it places an order for a Priority Assistance Connection, confirming that your organisation must have the required supporting documentation from the relevant Contracted End User.

What if nbn cannot complete a Priority Assistance Connection order in accordance with the required Service Level?

If it is likely that the order will not be completed within the required Service Level for Priority Assistance Connections, **nbn** will endeavour to update the order and advise your organisation within 2 hours after Order Acknowledgement, or as soon as reasonably practicable.

4.5.2 Connect Orders

To place an order, your organisation must use either the **nbn**® Service Portal or B2B Access, and complete the related Product Order Form.

4.5.2.1 Interactions: Connect Order

The following diagram illustrates the interactions between your organisation and **nbn** that can arise from the submission of a Connect Order.

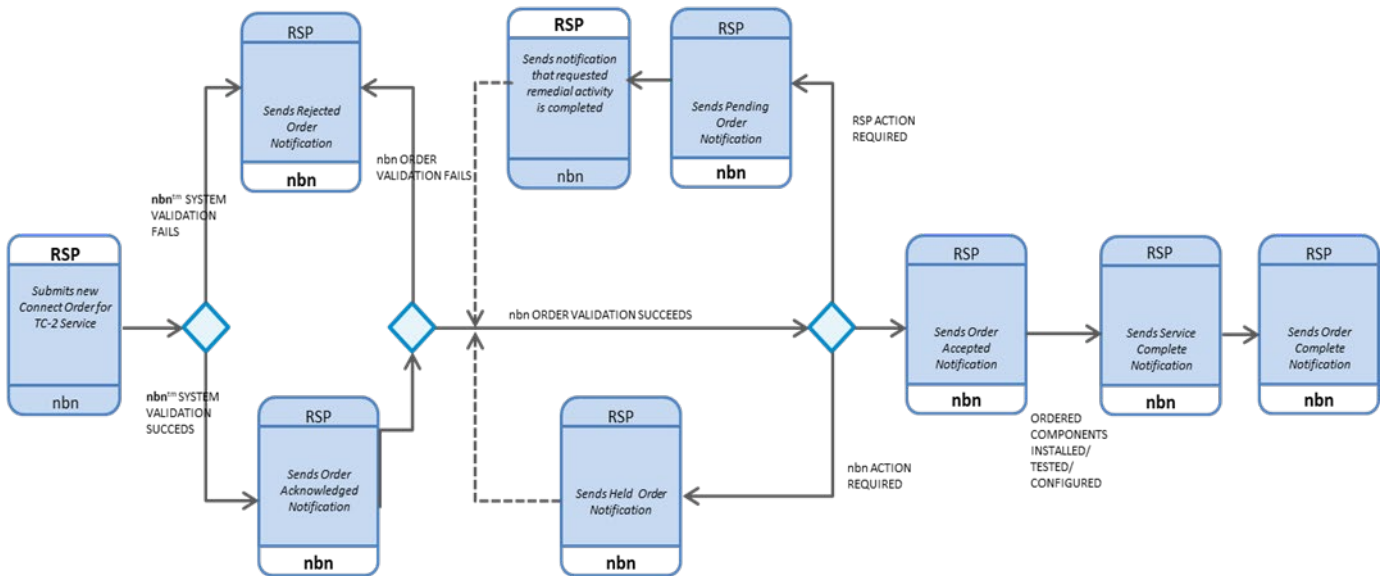



Description

The following table describes the interaction activities between your organisation and **nbn** that can arise from the submission of a Connect Order:



Important: Order notifications will include the order’s unique Order ID

Who	Activities
Your organisation...	<p>Submits a new Connect Order via the nbn® Service Portal or B2B Access. This includes the following:</p> <ul style="list-style-type: none"> Performing a Site Qualification Enquiry (or providing the nbn® Location ID if previously determined) (AVC order) Where prompted to do so, booking an Appointment (or providing the Appointment ID if previously reserved): <ul style="list-style-type: none"> for a Connect Order, in accordance with section 6.7.1 Selecting Appointments and for a Connect Order in respect of Premises associated with an Established POI CSA which were previously served by a Temporary POI CSA, in accordance with section 4.5.6.5 Orders in respect of Established POIs.

Who	Activities
	<p> Important: If your organisation places an order for an Accelerated Connection:</p> <ul style="list-style-type: none"> • At a Service Class 3, Service Class 13, Service Class 24 Premises or Service Class 34 Premises; or • In respect to a Service Class 12 Premises, Service Class 32 Premises or Service Class 33 Premises, if the order is a Transition Order as detailed in section 4.5.2.3 Transition Orders <p>it will be treated as an order for a Standard Connection.</p> <p> Important: If your organisation wishes to submit a Connect Order for an nbn[®] Ethernet (Wireless) Ordered Product at a Service Class 6 Premises, where:</p> <ul style="list-style-type: none"> • the Connect Order is for an AVC TC-4 bandwidth profile of Fixed Wireless Home Fast or Fixed Wireless Superfast; and • nbn determines that a W-NTD Upgrade Installation is required, then your organisation must: • submit a Connect Order for any other AVC TC-4 bandwidth profile (apart from Fixed Wireless Home Fast or Fixed Wireless Superfast); and • once the Connect Order is complete, submit a Modify Order for Fixed Wireless Home Fast or Fixed Wireless Superfast as desired. <p> Important: When your organisation reserves an Appointment for a Service Class 8 Premises, your organisation is reserving installation capacity. If your organisation reserves an Appointment in accordance with the requirements above, nbn will contact the Appointment Representative to schedule the Actual Appointment. See section 6.2 Appointment Overview.</p> <p>B2B Access only: An Appointment ID is not required to submit the Connect Order; however, the Order Status of the Connect Order will remain Pending until your organisation adds an Appointment ID (where required) to the Connect Order.</p>
nbn...	<p>Confirms that the Connect Order was submitted correctly and, depending on the result of the submission validation, does one of the following:</p> <ul style="list-style-type: none"> • <i>(If the Connect Order was submitted correctly)</i> Sends your organisation an Acknowledged Notification and updates the Order Status to Acknowledged <p>Note: Your organisation may cancel the order at this time</p> <ul style="list-style-type: none"> • <i>(If the Connect Order was not submitted correctly)</i> Sends your organisation a Rejected Notification if nbn rejects the order and updates the Order Status to Rejected.
nbn...	<p><i>(If the Connect Order was submitted correctly)</i> Confirms that the specific information provided in the Connect Order is sufficient to proceed with the order and, depending on the result of this validation, does one of the following:</p> <ul style="list-style-type: none"> • <i>(If nbn determines that the Connect Order is valid but nbn requires additional action from your organisation)</i> Sends your organisation a Pending Notification and updates the Order Status to Pending <p>Note: Your organisation may cancel the order at this time</p> <ul style="list-style-type: none"> • <i>(If nbn determines that the Connect Order is valid but additional nbn action is required, other than contacting the Appointment Representative in accordance with section 6.3.2 New Appointment Process in respect of a Connect Order for nbn[®] Ethernet (Satellite)),</i> sends your organisation a Held Order Notification and updates the Order Status to Held <p>These circumstances may include a situation where nbn requires information from an Other RSP or a third party owner or user of in-building cabling in order to proceed with an order (in which case, nbn's obligation to perform in accordance with any applicable Service Levels may be suspended until all necessary information has been provided in accordance with the applicable Service Levels Schedule).</p>

Who	Activities
	<p>Note: Your organisation may cancel the order at this time.</p> <p> Note: Held status may be subsequently updated to Pending status if your organisation needs a new Appointment ID after the nbn issue is resolved, and a new Appointment is required.</p> <ul style="list-style-type: none"> <i>(If nbn determines that the Connect Order is not valid)</i> Sends your organisation a Rejected Notification and updates the Order Status to Rejected Note: Your organisation will have to submit a new Connect Order for the related nbn[®] Location ID. <i>(After nbn determines that the Connect Order is valid and no additional action required, other than contacting the Appointment Representative in accordance with section 6.3.2 New Appointment Process in respect of a Connect Order for the nbn[®] Ethernet (Satellite), sends your organisation an Order Accepted Notification and updates the Order Status to In Progress</i> Note: Your organisation may cancel the order at this time except where the order is a Service Transfer Order.
Your organisation...	<p><i>(If your organisation receives a Pending Notification)</i> Responds to the requested action(s) contained in the Pending Notification.</p> <p>Note: A common request will be for your organisation to update or add an Appointment to the Order.</p> <p>Note: Your organisation may cancel the Connect Order at this time.</p>
nbn...	<p><i>(After configuring, activating, and completing testing of the Ordered Product Component(s))</i> Sends your organisation a "Service Test Completed Notification".</p>
nbn...	<p><i>(After completing and closing the Order)</i> Sends your organisation a Completed Notification and updates the Order Status to Complete.</p> <p>Note: The Product Instance IDs for the Ordered Product Components are now active.</p>

Note: Your organisation may only order Accelerated Connections if certain conditions apply. Your organisation must not incorrectly order End User Connections as Accelerated Connections if the conditions are not met in respect to an order (and must work collaboratively with **nbn** to avoid such orders).

 **Important:** Notes in this section [4.5.2.1 Interactions: Connect Order](#) indicating that your organisation may cancel orders when they have a particular status, are subject to time based limitations which apply to order cancellations in some circumstances, as set out in section [4.5.1.4 Point of No Return](#).

4.5.2.2 Product Component Orders: Additional Information

Your organisation must, in each Product Component order, include the information as specified by all fields in the relevant Product Order Form, as well as the additional information described in this section.

What happens if my organisation does not provide all of the required information?

nbn will do each of the following:

- Update the Order Status to **Pending**
- Ask your organisation to provide all the required information before proceeding with the order.

See **Order Status: Descriptions** in section [4.5.1.6 Order Status Life-cycle](#) for a detailed description of the Pending Order Status.



Important: For **nbn**[®] Ethernet (Satellite), if your organisation places an order for a Service Element for a Facilities Access Service, an NNI or a CVC through the **nbn**[®] Service Portal, your organisation must select the specific attributes detailed in the **nbn**[®] *Operations User Guide*.

When placing orders for Product Components, refer to the relevant section below for additional notes and support information.

nbn[®] Building Entry Service Orders (Type 1 Facilities)

Your organisation may order a **nbn**[®] Building Entry Service by submitting a Connect Order via the **nbn**[®] Service Portal, (**Note:** B2B Access is not offered for this business transaction).

Your organisation must place separate orders for the **nbn**[®] Building Entry Service in respect of each Type 1 Facility where your organisation wishes to order the **nbn**[®] Building Entry Service:

- At multiple Type 1 Facilities; or
- In relation to multiple lead-in or backhaul transmission cables at a Type 1 Facility.

Note: See section 4.5.2.7 **nbn**[®] Building Entry Service (Type 1 Facilities) for further information on how **nbn** will progress your organisation's order for the **nbn**[®] Building Entry Service.

ODF Termination Orders

After **nbn** has made the physical connection of your organisation's lead-in or backhaul transmission cables to an ODF Termination Point:

Who	Activities
nbn ...	Will advise your organisation and both parties will, at a mutually convenient time, perform a joint inspection of the connection works and your organisation may test the performance of the connection to determine, acting reasonably, whether the connection has been made in accordance with the Service Description for the Facilities Access Service .
Your organisation...	Will provide its own test equipment and ensure fibre hygiene is observed prior to connecting to any nbn [®] Equipment as not to cause contamination or damage to connectors.
Your organisation...	<i>(If your organisation, acting reasonably, determines that the connection works have not been performed in accordance with the Service Description for the Facilities Access Service), requests that nbn re-performs the works.</i>
nbn ...	Will re-perform the connection works, and this section will continue to apply until your organisation has determined, acting reasonably, that the connection has been made in accordance with the Service Description for the Facilities Access Service .

To waive your organisation's right to inspect the terminated cable, specify the waiver within the Product Order Form's "comments" field when placing the order.

Co-location Orders

Subject to the [Service Description for the Facilities Access Service](#), where your organisation places two orders (at the same time or consecutively) for Equipment Racks (being either full-height or half-height), **nbn** will endeavour to provision the second Equipment Rack in a non-adjacent rack space to the first Equipment Rack, unless otherwise requested by your organisation in the relevant order.

Upon the completion of an order for Co-location, your organisation must arrange physical access to install its equipment into the Equipment Rack by raising a Service Request via the **nbn**[®] Service Portal.



Important: Where **nbn** does not supply adjacent rack space, your organisation may be required to place additional orders for Cross Connects between Equipment Racks.

Cross Connect Orders

Where the cross connection is to, or from, a designated point on the **nbn**[®] ODF of any Other RSP, your organisation must do each of the following:

- When your organisation submits the order, provide **nbn** with a completed form for each Cross Connect requested within the order (**Cross Connect Authorisation Form**)
- Include the same internal reference ID captured in the Cross Connect order in the **Cross Connect Authorisation Form**
- Email the completed Cross Connect Authorisation Form(s) to the appropriate contact listed in the **Contact Matrix**.

Network-Network Interface (NNI) Orders



Important: In order for **nbn** to complete an NNI Order, your organisation must:

- have an ODF Termination Point or Co-location Connection Point available for the NNI to be connected to; and
- have the relevant Cross Connect order completed.

On acceptance of the NNI order:

Who	Activities
nbn...	Allocates the NNI Bearer(s), sends a notification with the NNI details and updates the Order Status to In Progress – Pending while waiting for your organisation to: <ul style="list-style-type: none"> • order the relevant Cross Connect(s) between those NNI Bearers and the relevant ODF Termination Point or Co-location Connection Point • schedule the activation of the NNI in conjunction with nbn upon receipt of the Cross Connect Completed Notification.
Your organisation...	(After the NNI position is known) Orders the relevant Cross Connect(s).
nbn...	Sends the Cross Connect Completed Notification(s).
Your organisation...	(Upon receipt of the Cross Connect Completed Notification(s)) Schedules activation of the NNI in conjunction with nbn
nbn...	Activates the NNI.

For each NNI order, your organisation must specify all of the following:

- The NNI redundancy mode (that is, *Single Chassis* or *Diverse Chassis*)
- The interface type required for each NNI.



Your organisation may only associate an NNI Product Component of **nbn**[®] Ethernet (Satellite) with a CVC Product Component of **nbn**[®] Ethernet (Satellite). Refer to the [nbn[®] Ethernet Product Description](#) for further information.

To add a Diverse Chassis NNI at a Point of Interconnect (POI) with an existing Single Chassis NNI

(If not eligible for an NNI Diversity Upgrade under section 4.5.6.1 Permitted Modifications to Product Components)

1. Place a *new* order for the Diverse Chassis NNI.
2. Order the required CVC for the Diverse Chassis NNI.

At the completion of this order, your organisation can commence migration activities relating to AVCs from the existing CVCs by placing a Modify Order for each AVC.

Upon completion of the AVC Modify Orders, your organisation can choose to place a Disconnect Order for the single chassis NNI or associated CVCs, in accordance with section 4.5.5 [Disconnect Orders](#).

(If eligible for an NNI Diversity Upgrade under section 4.5.6.1 Permitted Modifications to Product Components)

Place a Modify Order for an NNI Diversity Upgrade in accordance with that section and section 4.5.6.2 [Interactions: Modify Order](#).

Connectivity Virtual Circuit (CVC) Orders

Prerequisite: Your organisation must already have an active NNI in place for the POI serving the relevant CSA, before your organisation can place a CVC order in relation to that CSA.



Important: Your organisation may only associate a CVC Product Component of **nbn**[®] Ethernet (Satellite) with NNI and AVC Product Components of **nbn**[®] Ethernet (Satellite). Refer to the [nbn[®] Ethernet Product Description](#) for further information.



Important: For further information on CVC Orders related to the migration of Ordered Products from a Temporary POI CSA to an Established POI CSA, see section 4.5.6 [Temporary POI Migration Orders](#).

Access Virtual Circuit (AVC) Orders

Prerequisite: Your organisation must already have an active CVC for the relevant CSA before your organisation can place an AVC order in relation to that CSA.











Important: When creating an AVC order, your organisation can choose to submit it as a Standard Connection, or an Accelerated Connection subject to the requirements in the [nbn[®] Ethernet Service Levels Schedule](#), section 4.5.1.7 [Priority Assistance Connection Orders](#) and section 6.7.1 [Selecting Appointments](#).





See section 6.7.1 [Selecting Appointments](#) for details of Installation activities applicable for Access Component Orders.

nbn [®] Network	Activities
	<p>Each AVC order includes the UNI-D and Product Components for the Premises.</p> <p>Important: There may be a temporary service interruption when nbn performs a Fibre Upgrade Outage in respect of a Premises served by nbn[®] Ethernet (FTTC). See section 5.5.5 Fibre Upgrade Outage.</p>

nbn [®] Network	Activities				
	<p>What if a Customer Installed Fibre Cable Pathway is required?</p> <p>If nbn attends the Premises and determines, acting reasonably, that a Customer Installed Fibre Cable Pathway is required, nbn will not proceed with the Installation activities and will put the order into Pending until your organisation, the Downstream Service Provider, or the Contracted End User has arranged for such a Customer Installed Fibre Cable Pathway to be installed in accordance with any requirements communicated by nbn from time to time (see clauses C4.2 and C4.3 of the Head Terms) and all applicable laws, regulations and standards.</p> <p>UNI Port (data) Allocation</p> <p>nbn will accept UNI-D orders where a UNI-D port is not available but where a subsequent NTD may be installed.</p> <p>In these circumstances the UNI-D order will include an order for a subsequent NTD. See section 4.6.5 Subsequent Installations of NTDs.</p> <p>What if there are no available UNI ports at the NTD?</p> <p>nbn may install a subsequent NTD at the Premises within the scheduled time of the Appointment, and allocate the first available UNI-D on this NTD. See section 4.6.5 Subsequent Installations of NTDs for more information.</p> <p>What if an order relates to a Centralised Deployment in a Multi-Premises Site?</p> <p>nbn will install a subsequent NTD at each Multi-Premises Site for each different Non-Addressable Object in relation to which your organisation places a Connect Order subject to the following condition. nbn may decline to install a subsequent NTD for a Non-Addressable Object in any of the circumstances set out in section 4.6.5 Subsequent Installations of NTDs.</p>				
	<p>Prerequisite: nbn is not responsible for in-building cabling (other than Jumpering to be carried out in accordance with this Agreement) and cannot progress an order unless suitable in-building cabling connecting the Customer Side MDF to the relevant Premises exists. If nbn attends the Premises and suitable in-building cabling connecting the Customer Side MDF to the relevant Premises does not exist, nbn will not proceed with the Installation activities and will put the order into Pending.</p> <p>Each AVC order includes the UNI Product Component for the same Premises.</p> <p>The AVC order must include the following information:</p> <ul style="list-style-type: none"> • The requested FTTB Installation type (see FTTB Installation type descriptions below) • If your organisation is performing the Installation, the Customer Required Date for the activation of the nbn[®] Ethernet (FTTB) (optional) • Any information required by the relevant Product Order Form (e.g. if your organisation is requesting a Transition Order (see section 4.5.2.3 Transition Orders below), the FNN or ULL ID where required, and confirmation if your organisation wants nbn to install Voiceband Continuity (see section 4.5.2.4 Voiceband Continuity (optional) below). <p>FTTB installation type</p> <p>For each AVC order, your organisation must select one of the following installation types:</p>				
	<table border="1"> <thead> <tr> <th data-bbox="300 1823 635 1868">Installation Type</th> <th data-bbox="635 1823 1471 1868">Details</th> </tr> </thead> <tbody> <tr> <td data-bbox="300 1868 635 2042"> Standard Installation – Installation by nbn (Jumpering only) </td> <td data-bbox="635 1868 1471 2042"> This is a Standard Installation by nbn. Where required, nbn will perform Jumpering (which may include the installation of a Jumper Cable from the nbn[®] Side MDF to the Customer Side MDF) in respect of a Service Class 12 Premises or nbn[®] Copper Pair. </td> </tr> </tbody> </table>	Installation Type	Details	Standard Installation – Installation by nbn (Jumpering only)	This is a Standard Installation by nbn . Where required, nbn will perform Jumpering (which may include the installation of a Jumper Cable from the nbn [®] Side MDF to the Customer Side MDF) in respect of a Service Class 12 Premises or nbn [®] Copper Pair.
Installation Type	Details				
Standard Installation – Installation by nbn (Jumpering only)	This is a Standard Installation by nbn . Where required, nbn will perform Jumpering (which may include the installation of a Jumper Cable from the nbn [®] Side MDF to the Customer Side MDF) in respect of a Service Class 12 Premises or nbn [®] Copper Pair.				

nbn [®] Network	Activities
	<p>If requested in the AVC order, nbn will install Voiceband Continuity in accordance with section 4.5.2.4 Voiceband Continuity (optional).</p> <p>See section 6.7.1 Selecting Appointments for details of Installation activities applicable for Ordered Products.</p>
<p>Installation by your organisation</p>	<p>Installation by your organisation – this is not a Standard Installation or Non Standard Installation.</p> <p>Until such time as notified by nbn, your organisation, its Personnel, or any of its Related Bodies Corporate or any of their Personnel ('your organisation' for the purposes of this section):</p> <ul style="list-style-type: none"> • May only perform and complete an Installation for a Connect Order for a new or inactive nbn[®] Copper Pair; and • Must not perform and complete an Installation for a Transition Order, unless otherwise agreed by nbn. <p>Your organisation will install a Jumper Cable from the nbn[®] Side MDF to the Customer Side MDF as contractor to nbn. nbn will provide the X and C pair information for your organisation to complete the Jumper Cable installation through the existing order notifications via the nbn[®] Service Portal or B2B.</p> <p>Your organisation may install Voiceband Continuity as contractor to nbn subject to authorisation by nbn.</p> <p>It is optional for your organisation to include the Customer Required Date, in which case nbn will complete the Connect Order on this date.</p> <p>For an Installation by your organisation, an Appointment at the relevant Premises is not required.</p> <p>Your organisation must ensure that any technicians that carry out any works associated with an Installation by your organisation or a Downstream Service Provider are registered cabling, hold all relevant industry certifications and otherwise comply with all applicable laws, regulations and standards.</p>
<p>Optional Professional Wiring Service by nbn (nbn may charge your organisation for this type of installation, as specified in the nbn[®] Ethernet Price List)</p>	<p>This is optional and not part of a Standard Installation.</p> <p>Where your organisation has requested nbn to do so in the relevant AVC order, nbn will:</p> <ul style="list-style-type: none"> • where required perform a Standard Installation (Jumper Cable only) as described above (including any requested installation of Voiceband Continuity); and • carry out a Professional Wiring Service at the relevant Premises (in accordance with section 4.5.2.5 Professional Wiring Service (optional)) <p>nbn will require an Appointment to enter the relevant Premises for this installation type to perform a Professional Wiring Service.</p>
	<p>Important: If your organisation requests Voiceband Continuity for a Voiceband Service that is supplied by another retail service provider, nbn is not responsible for the termination of that Voiceband Service where the termination relates to any act or omission of the other retail service provider.</p>
	<p>Subsequent Installations of nbn[®] Ethernet (FTTB)</p> <p>The process and requirements described in this section apply to Subsequent Installations.</p> <p>Where a Subsequent Installation is performed by nbn (with or without a Professional Wiring Service), nbn may charge your organisation the Charges specified in the nbn[®] Ethernet Price List.</p>

nbn® Network	Activities										
	<p>Important:</p> <p>Prerequisite: nbn is not responsible for in-building cabling (other than Jumpering to be carried out in accordance with this Agreement) or civil works to extend or alter a serviceable pre-existing Lead-In Cable or Copper Connecting Cable within that Premises (regardless of the length of the pre-existing Lead-In Cable or Copper Connecting Cable). nbn cannot progress an order unless suitable:</p> <ul style="list-style-type: none"> • In-building cabling from the nbn® Network Boundary to the Telecommunications Outlet exists (where applicable); or • Civil works, where required in order to establish a Standard Installation have been undertaken. <p>If nbn attends the Premises and suitable in-building cabling or civil works do not exist, nbn will not proceed with the Installation activities and will put the order into Pending.</p>										
<p>Each AVC order includes the UNI Product Component for the same Premises.</p> <p>The AVC order must include any information required by the relevant Product Order Form (e.g. if your organisation is requesting a Transition Order (see section 4.5.2.3 Transition Orders), the FNN or ULL ID where required, and confirmation if your organisation wants nbn to install Voiceband Continuity (see section 4.5.2.4 Voiceband Continuity (optional) below).</p>											
<p>FTTN installation type</p> <p>For each AVC order, your organisation must select one of the following installation types:</p>											
<table border="1" style="width: 100%; border-collapse: collapse;"> <thead> <tr> <th style="width: 40%; padding: 5px;">Installation Type</th> <th style="padding: 5px;">Details</th> </tr> </thead> <tbody> <tr> <td style="padding: 5px; vertical-align: top;"> <p>Standard Installation – Installation by nbn</p> </td> <td style="padding: 5px;"> <p>This is a Standard Installation by nbn.</p> <p>Where required, nbn will install any Connecting Equipment in accordance with section 4.6.3 Standard Installations, in respect of a Service Class 11, 12 or 13 Premises or nbn® Copper Pair.</p> <p>If validly requested in the AVC order, nbn will install Voiceband Continuity in accordance with section 4.5.2.4 Voiceband Continuity (optional).</p> <p>See section 6.7.1 Selecting Appointments for details of Installation activities applicable for Access Component orders.</p> </td> </tr> <tr> <td style="padding: 5px;"></td> <td style="padding: 5px;"> <table border="1" style="width: 100%; border-collapse: collapse;"> <tr> <td style="width: 10%; text-align: center; vertical-align: middle;">  </td> <td style="padding: 5px;"> <p>Important: nbn may install the Connecting Equipment required to complete the Installation (e.g. aerial Lead-In Cable or underground Lead-In Cable). However, nbn is not responsible for any necessary civil works, as described in section 4.6.3 Standard Installations, and such works will not form part of a Standard Installation.</p> </td> </tr> </table> </td> </tr> <tr> <td style="padding: 5px; vertical-align: top;"> <p>Standard Installation and Optional Professional Wiring Service by nbn</p> <p>(nbn may charge your organisation for this type of installation, as specified in the nbn® Ethernet Price List)</p> </td> <td style="padding: 5px;"> <p>This is optional and not part of a Standard Installation.</p> <p>Where your organisation has validly requested nbn to do so in the relevant AVC order, nbn will:</p> <ul style="list-style-type: none"> • Where required, perform a Standard Installation as described above (including any requested installation of Voiceband Continuity); and • Carry out a Professional Wiring Service at the relevant Premises in accordance with section 4.5.2.5 Professional Wiring Service (optional). <p>nbn will require an Appointment to enter the relevant Premises for this installation type to perform a Professional Wiring Service.</p> </td> </tr> </tbody> </table>		Installation Type	Details	<p>Standard Installation – Installation by nbn</p>	<p>This is a Standard Installation by nbn.</p> <p>Where required, nbn will install any Connecting Equipment in accordance with section 4.6.3 Standard Installations, in respect of a Service Class 11, 12 or 13 Premises or nbn® Copper Pair.</p> <p>If validly requested in the AVC order, nbn will install Voiceband Continuity in accordance with section 4.5.2.4 Voiceband Continuity (optional).</p> <p>See section 6.7.1 Selecting Appointments for details of Installation activities applicable for Access Component orders.</p>		<table border="1" style="width: 100%; border-collapse: collapse;"> <tr> <td style="width: 10%; text-align: center; vertical-align: middle;">  </td> <td style="padding: 5px;"> <p>Important: nbn may install the Connecting Equipment required to complete the Installation (e.g. aerial Lead-In Cable or underground Lead-In Cable). However, nbn is not responsible for any necessary civil works, as described in section 4.6.3 Standard Installations, and such works will not form part of a Standard Installation.</p> </td> </tr> </table>		<p>Important: nbn may install the Connecting Equipment required to complete the Installation (e.g. aerial Lead-In Cable or underground Lead-In Cable). However, nbn is not responsible for any necessary civil works, as described in section 4.6.3 Standard Installations, and such works will not form part of a Standard Installation.</p>	<p>Standard Installation and Optional Professional Wiring Service by nbn</p> <p>(nbn may charge your organisation for this type of installation, as specified in the nbn® Ethernet Price List)</p>	<p>This is optional and not part of a Standard Installation.</p> <p>Where your organisation has validly requested nbn to do so in the relevant AVC order, nbn will:</p> <ul style="list-style-type: none"> • Where required, perform a Standard Installation as described above (including any requested installation of Voiceband Continuity); and • Carry out a Professional Wiring Service at the relevant Premises in accordance with section 4.5.2.5 Professional Wiring Service (optional). <p>nbn will require an Appointment to enter the relevant Premises for this installation type to perform a Professional Wiring Service.</p>
Installation Type	Details										
<p>Standard Installation – Installation by nbn</p>	<p>This is a Standard Installation by nbn.</p> <p>Where required, nbn will install any Connecting Equipment in accordance with section 4.6.3 Standard Installations, in respect of a Service Class 11, 12 or 13 Premises or nbn® Copper Pair.</p> <p>If validly requested in the AVC order, nbn will install Voiceband Continuity in accordance with section 4.5.2.4 Voiceband Continuity (optional).</p> <p>See section 6.7.1 Selecting Appointments for details of Installation activities applicable for Access Component orders.</p>										
	<table border="1" style="width: 100%; border-collapse: collapse;"> <tr> <td style="width: 10%; text-align: center; vertical-align: middle;">  </td> <td style="padding: 5px;"> <p>Important: nbn may install the Connecting Equipment required to complete the Installation (e.g. aerial Lead-In Cable or underground Lead-In Cable). However, nbn is not responsible for any necessary civil works, as described in section 4.6.3 Standard Installations, and such works will not form part of a Standard Installation.</p> </td> </tr> </table>		<p>Important: nbn may install the Connecting Equipment required to complete the Installation (e.g. aerial Lead-In Cable or underground Lead-In Cable). However, nbn is not responsible for any necessary civil works, as described in section 4.6.3 Standard Installations, and such works will not form part of a Standard Installation.</p>								
	<p>Important: nbn may install the Connecting Equipment required to complete the Installation (e.g. aerial Lead-In Cable or underground Lead-In Cable). However, nbn is not responsible for any necessary civil works, as described in section 4.6.3 Standard Installations, and such works will not form part of a Standard Installation.</p>										
<p>Standard Installation and Optional Professional Wiring Service by nbn</p> <p>(nbn may charge your organisation for this type of installation, as specified in the nbn® Ethernet Price List)</p>	<p>This is optional and not part of a Standard Installation.</p> <p>Where your organisation has validly requested nbn to do so in the relevant AVC order, nbn will:</p> <ul style="list-style-type: none"> • Where required, perform a Standard Installation as described above (including any requested installation of Voiceband Continuity); and • Carry out a Professional Wiring Service at the relevant Premises in accordance with section 4.5.2.5 Professional Wiring Service (optional). <p>nbn will require an Appointment to enter the relevant Premises for this installation type to perform a Professional Wiring Service.</p>										

nbn [®] Network	Activities
	<p> Important: If your organisation requests Voiceband Continuity for a Voiceband Service that is supplied by another retail service provider, nbn is not responsible for the termination of that Voiceband Service where the termination relates to any act or omission of the other retail service provider.</p> <p>Subsequent Installations of nbn[®] Ethernet (FTTN)</p> <p>The process and requirements described in this section apply to Subsequent Installations. Where a Subsequent Installation is performed by nbn (with or without a Professional Wiring Service), nbn may charge your organisation the Charges specified in the nbn[®] Ethernet Price List.</p>
	<p>Each AVC order includes the UNI Product Component for the same Premises. The AVC order must include any information required by the relevant Product Order Form. Your organisation may order Professional Wiring Service as a Product Component of nbn[®] Ethernet (FTTC), it is optional and not part of a Standard Installation – see section 4.5.2.5 Professional Wiring Service (optional).</p> <p> Important:</p> <p>Prerequisite: nbn is not responsible for In-building Wiring, in-building cabling or civil works to extend or alter a serviceable pre-existing Lead-In Cable or Copper Connecting Cable within that Premises (regardless of the length of the pre-existing Lead-In Cable or Copper Connecting Cable). nbn cannot progress an order unless suitable:</p> <ul style="list-style-type: none"> • In-building Wiring or in-building cabling from the nbn[®] Downstream Network Boundary to the Telecommunications Outlet exists (where applicable); or • civil works, where required in order to establish a Standard Installation have been undertaken. <p>If nbn attends the Premises and suitable In-building Wiring, in-building cabling or civil works do not exist, nbn will not proceed with the Installation activities and will put the order into Pending.</p> <p>nbn may disconnect an Ordered Product pursuant to section 5.3 of the nbn[®] Ethernet Product Terms if nbn becomes aware that an In-building Wiring Consent relating to that Ordered Product has not been properly obtained or has been withdrawn.</p> <p> Important: If your organisation places an order for a Service Class 31 or Service Class 32 nbn[®] Copper Pair, instead of activating the Service Class 32 or Service Class 33 nbn[®] Copper Pair at a Service Class 32 or Service Class 33 Premises. nbn will, in the first instance, reuse the nbn[®] DPU port that has previously been allocated to the nbn[®] Copper Pair with the highest Service Class.</p>
	<p>Each AVC order includes the UNI Product Component for the same Premises. Your organisation must supply any information required by the relevant Product Order Form.</p> <p>Medium/Large Business Premises limitation</p> <p>For nbn[®] Ethernet (Satellite) your organisation must, at the time of placing an AVC order for a Premises, confirm that the Premises is one of the following:</p> <ul style="list-style-type: none"> • A Medium/Large Business Premises that is currently receiving a Sky Muster[®] Service • Not a Medium/Large Business Premises. <p>Your organisation must not place, and nbn may decline, an AVC order for nbn[®] Ethernet (Satellite) in respect of a Premises that is a Medium/Large Business Premises that is not currently receiving a Sky Muster[®] Service.</p>

nbn [®] Network	Activities
	<p>Maximum AVC/UNI activation limits</p> <ul style="list-style-type: none"> For nbn[®] Ethernet (Satellite) your organisation must not place, and nbn may decline, an AVC order in respect of a Premises if the supply of the ordered AVC would result in nbn supplying more than one AVC TC-4 and one associated AVC TC-1 to all nbn retail service providers in respect of the Premises. <p>See the nbn[®] Ethernet Product Description for further information and exceptions for Public Interest Premises.</p> <p>Termination of existing services</p> <p>If your organisation’s AVC order involves the de-installation of any existing satellite equipment at the Premises, nbn’s supply of your organisation’s order will disrupt and terminate existing satellite services to the Premises.</p> <p>Refer to the nbn[®] Ethernet Product Description and the nbn[®] Ethernet Fair Use Policy for further information regarding ordering limitations for Access Components in connection with nbn[®] Ethernet (Satellite). Refer to the nbn[®] Ethernet Product Terms in respect of your organisation’s obligation to obtain all necessary consents for the de-installation of existing equipment at the Premises.</p> <p>Choice of power supply</p> <p>Your organisation may request its preferred type of Power Supply (Standard) in an AVC order.</p> <p>Exception: If your organisation places an AVC order in respect of a Premises at which a Power Supply (Standard) has been installed, your organisation must place a Modify Order to change the Power Supply (Standard) between AC and DC variants if required and an Equipment Modification (NTD indoor unit) Charge may apply in accordance with the nbn[®] Ethernet Price List. See section 4.5.4 Modify Orders.</p>
	<p>Each AVC order includes the UNI Product Component for the same Premises.</p> <p>The AVC order must include any information required by the relevant Product Order Form.</p> <div style="background-color: #e0f2f7; padding: 10px; margin-top: 10px;"> <p>What if an order relates to a Centralised Deployment in a Multi-Premises Site?</p> <p>nbn will install a subsequent NTD at each Multi-Premises Site for each different Non-Addressable Object in relation to which your organisation places a Connect Order subject to the following condition:-</p> <ul style="list-style-type: none"> nbn may decline to install a subsequent NTD for a Non-Addressable Object in any of the circumstances set out in section 4.6.5 Subsequent Installations of NTDs. </div>

Changes to AVC bandwidth profile / traffic class

To amend any of the bandwidth profile, traffic class or associated CVC of an AVC, your organisation must place a Modify Order for that AVC. See section 4.5.4 [Modify Orders](#).

AVC TC-2 bandwidth profile



This section applies to Access Component orders for **nbn[®]** Ethernet (FTTB) or **nbn[®]** Ethernet (FTTN).

(1) Order submission, acceptance and Installation

The following tables describe the interactions between your organisation and **nbn** that can arise from the submission of an order for an AVC TC-2 bandwidth profile for a Service Class 11, Service Class 12 or Service Class 13 **nbn[®]** Copper Pair from order submission to order acceptance to Installation:

Order Submission

Who	Service Class 11	Service Class 12	Service Class 13	Activity
Your organisation ...	N	Y	Y	Must perform a Site Qualification Enquiry to obtain the estimated AVC TC-2 bandwidth profiles available for the nbn [®] Copper Pair.
Your organisation ...	Y ¹	Y ²	Y ³	May submit the order for an AVC TC-2 bandwidth profile.
Your organisation ...	Y	Y ⁴	N	Must reserve an Appointment in accordance with section 6.7.1 Selecting Appointments .
nbn ...	Y	N	N	Will perform a Design Site Qualification.



Important: For an order requesting an AVC TC-2 bandwidth profile for a Service Class 11 **nbn**[®] Copper Pair, **nbn** will update the Order Status to **Acknowledged - Held** whilst **nbn** performs the Design Site Qualification.

¹ For Service Class 11, the estimated available AVC TC-2 bandwidth profiles will be indicated during Design Site Qualification after the order has been submitted and prior to order acceptance or rejection.

² For Service Class 12, your organisation may only submit an order for an AVC TC-2 bandwidth profile which is indicated as available by the Site Qualification Enquiry.

³ For Service Class 13, your organisation may only submit an order for an AVC TC-2 bandwidth profile which is indicated as available by the Site Qualification Enquiry.

⁴ For Service Class 12, if the order is for **nbn**[®] Ethernet (FTTB) and your organisation selects the installation type referred to as "Installation by your organisation", your organisation must follow the installation process for that installation type set out in the [WBA Operations Manual](#). Following completion of the installation, if a Network Activity is required to support the CIR Objective, your organisation may submit a Trouble Ticket in accordance with section [5.2.3 Raising, Validating and Resolving a Trouble Ticket](#) (and standard Trouble Ticket process will then apply).

Order Acceptance (after order submission)

Who	Service Class 11	Service Class 12	Service Class 13	Activity
nbn ...	Y	Y	Y	<p>Will compare the Estimated Speed for the ordered nbn[®] Copper Pair with the requested AVC TC-2 bandwidth profile and:</p> <ul style="list-style-type: none"> • (If Design Site Qualification or Site Qualification Enquiry (as relevant) indicates that the nbn[®] Copper Pair is not capable of supporting the ordered AVC TC-2 bandwidth profile and the nbn[®] Copper Pair is not a Transitioning Special Services Line), will update the Order Status to Rejected and send a Rejected Notification; or • (If Design Site Qualification or Site Qualification Enquiry (as relevant) indicates that the nbn[®] Copper Pair is capable of supporting the ordered AVC TC-2 bandwidth profile or if the nbn[®] Copper Pair is a Transitioning Special Services Line), will update the Order Status to In Progress and send an Order Accepted Notification.

Installation (after order acceptance)

Who	Service Class 11	Service Class 12	Service Class 13	Activity
nbn ...	Y	Y	N	<p>Will, after accepting the order in accordance with the subsection above, install the Connecting Equipment for the nbn[®] Ethernet Ordered Product and proactively test the ability of the nbn[®] Copper Pair to support the AVC TC-2 bandwidth profile.</p>
nbn ...	N	N	Y	<p>Will,</p> <ul style="list-style-type: none"> • after accepting the order in accordance with the subsection above, configure, activate and remotely test the nbn[®] Ethernet Ordered Product; and • update the Order Status to Completed.

(2) AVC TC-2 bandwidth profile is not supported after order acceptance (Service Class 11 and Service Class 12)

The tables below set out the three scenarios for AVC TC-2 bandwidth profile Connect Orders for **nbn**[®] Copper Pairs that:

- are Service Class 11 or Service Class 12 **nbn**[®] Copper Pairs; and
- are not capable of supporting the ordered AVC TC-2 bandwidth profile, as determined by **nbn** following acceptance of the order.

These scenarios are:

- Scenario A: Transitioning Special Service Line unsupported due to a reason other than an interfering transitioning Designated Special Service
- Scenario B: Transitioning Special Service Line unsupported due to a transitioning Designated Special Service

- Scenario C: **nbn**[®] Copper Pair that is not a Transitioning Special Services Line.



Important: If permitted below and your organisation requests a Network Activity prior to order completion or elects to submit a Trouble Ticket after order completion and **nbn** designates that a Network Activity is required, early termination/modification Charges may apply in accordance with the [nbn[®] Ethernet Price List](#).

Scenario A: Transitioning Special Service Line unsupported due to reason other than interfering Designated Special Service

*(If the **nbn**[®] Copper Pair is a Transitioning Special Services Line and **nbn** determines that the **nbn**[®] Copper Pair is not capable of supporting the ordered AVC TC-2 bandwidth profile for a reason other than the interaction between the **nbn**[®] Ethernet Ordered Product and a Designated Special Service which is continuing to be supplied but is to be transitioned to that **nbn**[®] Ethernet Ordered Product):*

Who	Activity (Service Class 11 and 12 only)
nbn ...	Will, <ul style="list-style-type: none"> update the Order Status to In Progress – Pending; and send a notification to your organisation informing your organisation that a Network Activity is required for the nbn[®] Copper Pair to be capable of supporting the ordered AVC TC-2 bandwidth profile.
Your organisation...	Must do one of the following after receiving the notification from nbn : <ul style="list-style-type: none"> request a Network Activity to the CIR Objective be completed; request that the order be completed and notify nbn that your organisation intends to, within 30 Business Days after order completion, raise a Trouble Ticket in accordance with section 5.2.3 Raising, Validating and Resolving a Trouble Ticket to request nbn to perform a Network Activity in respect of the nbn[®] Copper Pair; request that the order be completed and notify nbn that your organisation intends to, within 20 Business Days after order completion, submit a Modify Order for the nbn[®] Ethernet Ordered Product in accordance with section 4.5.4 Modify Orders to either: <ul style="list-style-type: none"> remove the requested AVC TC-2 bandwidth profile; or request a lower available AVC TC-2 bandwidth profile that is capable of being supported by the relevant nbn[®] Copper Pair; cancel the order in accordance with section 4.5.1.3 Cancelling Orders; or request that the order be completed and notify nbn that your organisation accepts that, after order completion, the AVC TC-2 bandwidth profile will not achieve its CIR Objective.



Important: If a Network Activity is required to support the CIR Objective and the order is a Transition Order, the order is not completed until a Network Activity has been completed.

Scenario B: Transitioning Special Service Line unsupported due to a transitioning Designated Special Service

*(If the **nbn**[®] Copper Pair is a Transitioning Special Services Line and **nbn** determines that the **nbn**[®] Copper Pair is not capable of supporting the ordered AVC TC-2 bandwidth profile due to the interaction between the **nbn**[®] Ethernet Ordered Product and a Designated Special Service which is continuing to be supplied but is to be transitioned to that **nbn**[®] Ethernet Ordered Product)*

Who	Activity (Service Class 11 and 12 only)
nbn ...	<p>Will,</p> <ul style="list-style-type: none"> • update the Order Status to In Progress – Pending; and • send a notification to your organisation informing your organisation that a Network Activity will not be carried out.
Your organisation...	<p>Must do one of the following after receiving the notification from nbn:</p> <ul style="list-style-type: none"> • request that the order be completed and notify nbn that your organisation accepts that, after order completion, the AVC TC-2 bandwidth profile will not achieve its CIR Objective until the transitioning Designated Special Service is disconnected; • request that the order be completed and notify nbn that your organisation intends to, within 20 Business Days after order completion, submit a Modify Order for the nbn[®] Ethernet Ordered Product in accordance with section 4.5.4 Modify Orders to either: <ul style="list-style-type: none"> • remove the requested AVC TC-2 bandwidth profile; or • request a lower available AVC TC-2 bandwidth profile that is capable of being supported by the relevant nbn[®] Copper Pair; or • cancel the order in accordance with section 4.5.1.3 Cancelling Orders.

Scenario C: **nbn**[®] Copper Pairs that are not Transitioning Special Services Line

*(If the **nbn**[®] Copper Pair is not a Transitioning Special Services Line and **nbn** determines, after Order Acceptance, that the **nbn**[®] Copper Pair is not capable of supporting the ordered AVC TC-2 bandwidth profile)*

Who	Activity (Service Class 11 and 12 only)
nbn ...	<p>Will,</p> <ul style="list-style-type: none"> • update the Order Status to In Progress – Pending; and • send a notification to your organisation informing it whether nbn will, on request, perform a Network Activity to ensure that the nbn[®] Copper Pair will be capable of supporting the ordered AVC TC-2 bandwidth profile.
Your organisation...	<p>Must do one of the following and notify nbn of its election prior to order completion (if applicable):</p> <ul style="list-style-type: none"> • <i>(If nbn notifies your organisation that nbn will, on request, perform a Network Activity and your organisation elects to request a Network Activity)</i> either: <ul style="list-style-type: none"> • request a Network Activity to the CIR Objective be completed; or • request that the order be completed and notify nbn that your organisation intends to within 30 Business Days after order completion, raise a Trouble Ticket in accordance with section 5.2.3 Raising, Validating and Resolving a Trouble Ticket to request nbn to perform a Network Activity in respect of the nbn[®] Copper Pair; • <i>(if nbn notifies your organisation that it will not perform a Network Activity, or if your organisation elects not to request a Network Activity)</i> request that the order be completed and notify nbn that your organisation intends to, within 20 Business Days after order completion, submit a Modify Order for the nbn[®] Ethernet Ordered Product in accordance with section 4.5.4 Modify Orders to either: <ul style="list-style-type: none"> • remove the requested AVC TC-2 bandwidth profile; or • request a lower available AVC TC-2 bandwidth profile that is capable of being supported by the relevant nbn[®] Copper Pair; • cancel the order in accordance with section 4.5.1.3 Cancelling Orders; or • request that the order be completed and notify nbn that your organisation accepts that, after order completion, the AVC TC-2 bandwidth profile will not achieve its CIR Objective.



Important:

- If the CIR Objective cannot be met upon Installation, **nbn** will endeavour, where possible and requested by your organisation, to roll back any installation work undertaken as part of the Installation, to leave the end user service as it was previously identified.
- Where your organisation elects to modify an AVC TC-2 Product Component after order completion, your organisation will be charged for the originally ordered AVC TC-2 bandwidth profile in accordance with the [nbn® Ethernet Price List](#) until your Modify Order is completed.

(3) Consequences of completing order without nbn performing a Network Activity

For each scenario above, if **nbn** completes an order without having performed a Network Activity, the following consequences will apply depending on the situation, as set out in the table below:

Situation	Consequences
nbn has determined that the nbn ® Copper Pair is not capable of supporting the ordered AVC TC-2 bandwidth profile due to the interaction between the nbn ® Ethernet Ordered Product and a Designated Special Service which is continuing to be supplied but is to be transitioned to that nbn ® Ethernet Ordered Product.	<ul style="list-style-type: none"> • Your organisation must not submit a Trouble Ticket in relation to the Information Rate of the nbn® Ethernet Ordered Product until the relevant Designated Special Service is disconnected • nbn may reject or cancel any such Trouble Ticket or update the Trouble Ticket Status to Resolved.
Your organisation has notified nbn that it intends to raise a Trouble Ticket to request nbn to perform a Network Activity, within 30 Business Days after order completion	Your organisation must, within 30 Business Days after order completion, raise a Trouble Ticket to request nbn to perform a Network Activity
Your organisation has notified nbn that it intends to submit a Modify Order for the nbn ® Ethernet Ordered Product, within 20 Business Days after order completion, to either: <ul style="list-style-type: none"> • remove the requested AVC TC-2 bandwidth profile; or • request a lower available AVC TC-2 bandwidth profile that is capable of being supported by the relevant nbn® Copper Pair. 	<ul style="list-style-type: none"> • Your organisation must not submit a Trouble Ticket in relation to the Information Rate of the nbn® Ethernet Ordered Product until the relevant Modify Order is completed • nbn may reject or cancel any such Trouble Ticket, or update the Trouble Ticket Status to Resolved, where that Trouble Ticket is submitted by your organisation in relation to the Information Rate of the nbn® Ethernet Ordered Product at any time until your organisation submits a relevant Modify Order.
Your organisation has notified nbn that your organisation accepts that, after order completion, the AVC TC-2 bandwidth profile will not achieve its CIR Objective.	nbn may reject or cancel any such Trouble Ticket, or update the Trouble Ticket Status to Resolved , where that Trouble Ticket is submitted by your organisation in relation to the Information Rate of the nbn ® Ethernet Ordered Product.
nbn notifies your organisation, after order completion: <ul style="list-style-type: none"> • the relevant Service Class 13 nbn® Copper Pair is not capable of supporting the ordered AVC TC-2 bandwidth profile to achieve its CIR Objective • in accordance with section 5.2.8.2 Network Activity, nbn will not designate that the nbn® Copper Pair requires a Network Activity. 	nbn may reject or cancel any such Trouble Ticket, or update the Trouble Ticket Status to Resolved , where that Trouble Ticket is submitted by your organisation in relation to the Information Rate of the nbn ® Ethernet Ordered Product.

Note:

- In Scenarios A and C above, it may be possible for your organisation to request a Network Activity before an order is completed (as set out in the tables above).
- The following processes apply if the tables above allow your organisation to request a Network Activity before the order is completed.
- If applicable, **nbn** may, under section [5.2.8.2 Network Activity](#), request that your organisation reserve an appointment to progress the Network Activity or to complete the order.

(4) Network Activity pathways, before order completion

(If your organisation has requested **nbn** to perform a Network Activity in accordance with the scenario tables above before order completion):

Who	Activity (Service Class 11 and 12 only)
nbn ...	Will designate that a Network Activity is required to support the CIR Objective and update the Order Status to In Progress – Held and perform the Network Activity in accordance with section 5.2.8 Network Activity
nbn ...	(Once nbn has successfully finished the Network Activity (Rehabilitation) works) Will update the Order Status to In Progress and complete the order.
Your organisation ...	(Once nbn has finished the Network Activity (COAT) works) Must cancel the order in accordance with section 4.8 Changes of Access Technology .

4.5.2.3 Transition Orders



This section applies to Access Component orders for **nbn**® Ethernet (FTTB), **nbn**® Ethernet (FTTN) or **nbn**® Ethernet (FTTC).



Important:

Until such time as notified by **nbn**, your organisation, its Personnel, or any of its Related Bodies Corporate or any of their Personnel:

- may only perform and complete an installation for a Connect Order for a new or inactive **nbn**® Copper Pair; and
- must not perform and complete an installation for a Transition Order, unless otherwise agreed by **nbn**.

**Important:**

- Your organisation must obtain FTTB/FTTN Installation Consent or FTTC Installation Consent in accordance with section 5 of the [nbn[®] Ethernet Product Terms](#).
- **nbn** will not process a Transition Order (with or without Voiceband Continuity) that does not contain an accurate FNN or ULL ID, where required, for the **nbn[®]** Copper Pair ID to be transitioned.

Exception: **nbn** will process the Transition Order without your organisation submitting a valid FNN or ULL ID where:

- there is only one ULLS supplied to the Premises, or
- the Transition Order is a valid Connect Outstanding Transition Order.

Your organisation must ensure that all other details required by the Product Order Form for the Transition Order are accurate.

- If your organisation cannot identify the relevant FNN or ULL ID, your organisation:
 - may order the **nbn[®]** Ethernet Product as a new connection. In this case, the new connection may be a Subsequent Installation – see section [4.5.2 Connect Orders](#); or
 - may submit a Connect Outstanding Transition Order where relevant.
 Voiceband Continuity will not be available in either of the above cases.
- **nbn** may, acting reasonably, change the status of a Connect Order to **Held** if any copper plant records that are necessary for **nbn** to fulfil the order are not readily available to **nbn**.

Your organisation must ensure that each Downstream Service Provider and Contracted End User is aware, prior to the time of the Appointment, that the Installation and Activation of **nbn[®]** Ethernet (FTTB), **nbn[®]** Ethernet (FTTN) or **nbn[®]** Ethernet (FTTC):

- Will result in the permanent disconnection of any:
 - Non-Voiceband Service (e.g. a service that is being provided in the higher spectrum (generally used for ADSL or Telstra Special Services)); and
 - Voiceband Service in respect of which Voiceband Continuity has not been installed, or where **nbn** is unable to reinstate the relevant Line forming part of the Other Copper Network, or **nbn[®]** Copper Network in accordance with the Voiceband Reinstatement or Transition Reversal process; and
- For **nbn[®]** Ethernet (FTTB) or **nbn[®]** Ethernet (FTTN), may result in the temporary interruption or disconnection of any Voiceband Service in respect of which Voiceband Continuity has been requested.

See section 31 of the [nbn[®] Ethernet Product Terms](#) for further information.



Important: The Installation and Activation of **nbn[®]** Ethernet (FTTC) in respect of a Premises served by the FTTC Network will result in permanent disconnection of Voiceband Services and Non-Voiceband Services supplied to that Premises on the Line on which that Ordered Product is supplied.



Important: More than one **nbn[®]** Copper Pair may be connected to a Premises and the **nbn[®]** Ethernet (FTTB), **nbn[®]** Ethernet (FTTN) or **nbn[®]** Ethernet (FTTC) will need to be ordered individually in respect to each **nbn[®]** Copper Pair.



Important: If, in connection with a Transition Order, your organisation intends to port the FNN from an existing Voiceband Service to a new **nbn[®]** Ethernet Ordered Product, **nbn** recommends that your organisation submits its Simple Notification Advice (SNA) as soon as possible after placing that Transition Order with **nbn** and, at the latest, before **nbn** completes the relevant FTTB/FTTN Installation Activities or FTTC Installation Activities and sends the Completion Advice to your organisation.



Important: Your organisation must have an EPID Code, and if your organisation has more than one EPID Code, it must nominate which EPID Code it wishes **nbn** to use in connection with Transition Advice Information.

nbn may also disclose your organisation's identity to Telstra for the purposes of notifying Telstra that your organisation may place orders for Products in respect of Service Class 11, Service Class 12, Service Class 13, Service Class 31, Service Class 32, Service Class 33 or Service Class 34 Premises.



Important: Your organisation may request a Transition Reversal if, after an order for **nbn**[®] Ethernet (FTTB), **nbn**[®] Ethernet (FTTN) or **nbn**[®] Ethernet (FTTC) placed by your organisation is Completed, your organisation becomes aware that:

1. the order was placed without valid authority from the Contracted End User (including without a valid FTTB/FTTN Installation Consent or FTTC Installation Consent); and
2. the Contracted End User wants the **nbn**[®] Ethernet (FTTB), **nbn**[®] Ethernet (FTTN) or **nbn**[®] Ethernet (FTTC) to be disconnected and its prior telecommunications service in respect of the relevant **nbn**[®] Copper Pair to be reinstated.

nbn will perform a Transition Reversal if, within 5 Business Days of the Completed Notification, your organisation lodges:

1. a Disconnect Order; and
2. a Service Request requesting a Transition Reversal and provides **nbn** with:
 - a. the accurate FNN or ULL ID for the existing retail service that is to be re-provisioned; and
 - b. evidence of the agreement to a Transition Reversal made between your organisation and the Voiceband Service or Non-Voiceband Service provider.

nbn may charge your organisation for a Transition Reversal, as specified in the [nbn[®] Ethernet Price List](#).

Consequences of invalid or inaccurate FNN or ULL ID

nbn will not process a Transition Order (with or without Voiceband Continuity) that does not contain an accurate FNN or ULL ID where required for the **nbn**[®] Copper Pair ID to be transitioned, except where:

- there is only one ULLS provided to the Premises (where **nbn** will process the Transition Order without your organisation submitting a valid ULL ID); or
- the Transition Order is a valid Connect Outstanding Transition Order, in which case Voiceband Continuity will not be available.

Where your organisation's order is **Rejected** or **Cancelled** due to an invalid FNN or ULL ID, your organisation may:

- Order **nbn**[®] Ethernet as a new connection if it cannot identify the relevant FNN or ULL ID. Voiceband Continuity will not be available in this case, and the new connection may be a Subsequent Installation - see section 4.5.2 [Connect Orders](#); or
- Request **nbn** investigate the FNN or ULL ID by submitting a Service Request and providing **nbn** with details relating to why your organisation considers that the FNN or ULL ID it submitted for the Transition Order is valid for the service to be transitioned.

nbn will investigate the FNN or ULL ID, and notify your organisation if the FNN or ULL ID your organisation submitted for the Transition Order is valid for the service to be transitioned. If the FNN or ULL ID is found to be valid following investigation, your organisation may resubmit the order with the relevant FNN or ULL ID.

Connect Outstanding Transition Order

A Connect Outstanding Transition Order is a Transition Order in respect of a Service Class 12, Service Class 32 or Service Class 33 **nbn**[®] Copper Pair where:

- an active legacy retail service supplied over the **nbn**[®] Copper Pair to be transitioned has not been disconnected; and
- the Authorised Account Holder of the relevant active legacy retail service is not the same as the prospective Contracted End User who has provided a Customer Authority to your organisation.



Note: A Connect Outstanding Transition Order may be available where an Authorised Account Holder has vacated the relevant premises but the service supplied to that Authorised Account Holder has not been disconnected.

Your organisation may submit a Connect Outstanding Transition Order from the Connect Outstanding Transition Date.

By submitting a Connect Outstanding Transition Order, your organisation warrants that it has:

- a Customer Authority applicable to the Premises or other location that is the subject of the Connect Outstanding Transition Order; and
- complied with its obligations under the Connect Outstanding Code (where applicable) in respect to the relevant **nbn**[®] Copper Pair prior to submitting the Transition Order.

The following table describes the interactions between your organisation and **nbn** that can arise from the submission of a Connect Outstanding Transition Order.

Who	Activities
<p>Your organisation...</p>	<p>may submit a Connect Outstanding Transition Order on an active Service Class 12, Service Class 32 or Service Class 33 nbn[®] Copper Pair.</p> <p>The following information must be provided in the Connect Outstanding Transition Order:</p> <ul style="list-style-type: none"> • Location ID • Street address • nbn[®] Copper Pair ID • Requested date of activation of the intended Ordered Product in respect of the relevant nbn[®] Copper Pair • Connect Outstanding attribute. <p>NOTE:</p> <ul style="list-style-type: none"> • nbn will process a Connect Outstanding Transition Order without your organisation submitting a valid FNN or ULL ID in a Connect Outstanding Transition Order. • Voiceband Continuity is not available for a Connect Outstanding Transition Order.
<p>nbn ...</p>	<p>will validate the Connect Outstanding Transition Order.</p> <p>Will consider order validation has failed, and update the Order Status to Rejected if:</p> <ul style="list-style-type: none"> • Voiceband Continuity is selected, or • the nbn[®] Copper Pair selected is not an active Service Class 12, Service Class 32 or Service Class 33 nbn[®] Copper Pair. <p>(If the Connect Outstanding Transition Order passes the validation) will update the Order Status to In Progress.</p>

4.5.2.4 Voiceband Continuity (optional)



This section applies to Access Component orders for **nbn**[®] Ethernet (FTTB) or **nbn**[®] Ethernet (FTTN).

The purpose of Voiceband Continuity is to provide the physical infrastructure that will support the continued provision of Voiceband Services to End Users by your organisation or a third party.



Important: Voiceband Continuity does not include the provision by **nbn** of any Voiceband Services. Voiceband Continuity is not part of **nbn**[®] Ethernet.

Your organisation must make Downstream Service Providers and Contracted End Users aware that:

- a Voiceband Service will only continue to be supplied where your organisation has validly ordered Voiceband Continuity from **nbn** and the End User's Voiceband Service provider continues to supply the Voiceband Service in respect to the **nbn**[®] Copper Pair after completion of the Transition Order; and
- it is possible that the End User's Voiceband Service provider may cease to supply the continued supply of the Voiceband Service in respect to the **nbn**[®] Copper Pair after completion of the Transition Order.

After **nbn** is made aware that the End User's Voiceband Service provider has ceased to supply the Voiceband Service in respect to the **nbn**[®] Copper Pair and Voiceband Continuity is no longer required, **nbn** will modify the configuration of the Ordered Product to show that Voiceband Continuity is no longer supported in respect of that Ordered Product.

If your organisation is placing Transition Order involving a Voiceband Service, supplied by your organisation or a third party using the Other Copper Network or **nbn**[®] Copper Network, that your organisation wants to be maintained after activation of the **nbn**[®] Ethernet (FTTB) or **nbn**[®] Ethernet (FTTN) Ordered Product, your organisation must, where required, provide in the Product Order Form the FNN or ULL ID for all existing Voiceband Services that are to be maintained, and request installation of Voiceband Continuity in the order. Your organisation must ensure that any FNN or ULL ID provided is accurate.

Voiceband Continuity is not available:

- where the existing retail service supplied on that **nbn**[®] Copper Pair is a Telstra Special Service; or
- for a Connect Outstanding Transition Order.

Notwithstanding section [4.5.1.2 Amending Orders](#), your organisation must not place an Amendment Order requesting Voiceband Continuity after placement of the original AVC order in respect of an **nbn**[®] Copper Pair (and **nbn** will not accept any such Amendment Order).



Important: If your organisation places an order that does not request Voiceband Continuity, and becomes aware that Voiceband Continuity is required once the order is **Completed**, then your organisation must:

- lodge a Service Request within 5 Business Days of the Completed Notification and request Voiceband Reinstatement; and
- provide **nbn** with the accurate FNN or ULL ID for the existing retail service that is to be reprovisioned, and evidence of the agreement to reinstate made between your organisation and the Voiceband Service provider.

If the above conditions are met, **nbn** will (if Voiceband Continuity is available in respect of the Premises) perform Voiceband Reinstatement.

nbn may charge your organisation for this type of installation, as specified in the **nbn**[®] Ethernet Price List.



Important: **nbn** is not responsible for the porting of the FNN. **nbn** will notify your organisation when the AVC order is complete, so that your organisation can coordinate the porting of the FNN.

4.5.2.5 Professional Wiring Service (optional)



Important: This section applies to Access Component orders for **nbn**[®] Ethernet (FTTB), **nbn**[®] Ethernet (FTTN) or **nbn**[®] Ethernet (FTTC).

A Professional Wiring Service is optional and not part of a Standard Installation.

**Important:**

In respect of **nbn**[®] Ethernet (FTTB), a Professional Wiring Service involves **nbn**[®] Personnel attending the relevant Premises to install a Central Splitter which will comply with AS/CA S041.3:2015.

**Important:**

In respect of a Service Class 11 and Service Class 12 **nbn**[®] Copper Pair for **nbn**[®] Ethernet (FTTN), a Professional Wiring Service involves **nbn**[®] Personnel attending the relevant Premises to install a Central Splitter which will comply with AS/CA S041.3:2015.

In respect of a Service Class 13 **nbn**[®] Copper Pair for **nbn**[®] Ethernet (FTTN), a Professional Wiring Service, may involve **nbn**[®] Personnel attending the relevant Premises to perform one or more of the following:

- Isolate the Lead-In Cable from other internal copper wiring within the Premises by disconnecting second or subsequent telecommunications outlet(s) from the **nbn**[®] Copper Pair at the Telecommunications Outlet;
- Enable re-use of secondary cabling by terminating the remaining cabling, including to second or subsequent telecommunications outlet(s);
- Install new internal copper wiring;
- Install, relocate or replace telecommunication outlet(s);
- Install a Central Splitter which will comply with AS/CA S041.3:2015; and
- Remove a Central Splitter.

**Important:**

In respect of a Service Class 34 Premises for **nbn**[®] Ethernet (FTTC), a Professional Wiring Service may involve **nbn**[®] Personnel attending the relevant Premises to perform one or more of the following:

- Isolate the Lead-In Cable from other internal copper wiring within the Premises by disconnecting second or subsequent telecommunications outlet(s) from the **nbn**[®] Copper Pair at the Telecommunications Outlet;
- Enable re-use of secondary cabling by terminating the remaining cabling, including to second or subsequent telecommunications outlet(s);
- Install new internal copper wiring;
- Install, relocate or replace telecommunication outlet(s).

A Professional Wiring Service is not available in respect of a Service Class 31, Service Class 32 or Service Class 33 Premises.

Prior to ordering a Professional Wiring Service your organisation must and must ensure that Downstream Service Providers, obtain, or procure that the Contracted End User obtains, consent for **nbn** and its Personnel to carry out the installation activities required to perform a Professional Wiring Service as set out in this section [4.5.2.5](#).

A Professional Wiring Service may be ordered by your organisation in accordance with clause [4.5.2.2 Product Component Orders: Additional Information](#) or occur in accordance with section [5.2.6 External Faults](#). The Charges which apply for a Professional Wiring Service are as specified in the [nbn[®] Ethernet Price List](#).

Note: If your organisation places a Connect Order in respect of a Service Class 13 **nbn**[®] Copper Pair or Service Class 34 **nbn**[®] Copper Pair and wants **nbn** to carry out a Professional Wiring Service, your organisation must:

- first lodge a Connect Order without requesting the Professional Wiring Service
- once the Connect Order is complete, lodge a Modify Order for the Professional Wiring Service.

Any installation activity carried out by **nbn** to perform a Professional Wiring Service is an activity performed by **nbn** under this Agreement at your organisation’s request.

nbn will carry out the Professional Wiring Service with due care and skill. Where **nbn** installs a Central Splitter, **nbn** will conduct tests to confirm that, at the time of installation, the Central Splitter is Compatible.



Important:

Your organisation must not (and must use reasonable endeavours to procure that no Downstream Service Provider or Contracted End User does):

- remove a Central Splitter that is installed on the **nbn**® Network, except where in accordance with the Authorisation to Alter Document; or
- prevent, or impose conditions on, the use of any Central Splitter, after it ceases to be used in relation to an RSP Product or Downstream Product.

nbn may notify your organisation if **nbn** considers that any in-premises wiring is adversely affecting the performance of any **nbn**® Ethernet Ordered Product, RSP Product or Downstream Product.

If **nbn** provides your organisation with a notification under the paragraph above, at the next End User Contact Event, your organisation must use reasonable endeavours to inform the Contracted End User that **nbn** considers that the in-premises wiring may be adversely affecting the performance, or End User experience, of an **nbn**® Ethernet Ordered Product, RSP Product or Downstream Product (as applicable), together with any additional details provided by **nbn** regarding the effect of the in-premises wiring.

4.5.2.6 Service Transfer Orders

A Service Transfer Order allows your organisation to transfer an existing **nbn**® Ethernet Product supplied to an Other RSP to your organisation in respect of a Service Class 3, Service Class 6, Service Class 9, Service Class 13, Service Class 24 or a Service Class 34 Premises using a Service Transfer or a Connect Outstanding Transfer.



Important: If a Fibre Connect Connection is available at a Premises in accordance with section 4.8.2.2 [Fibre Connect Connection](#), your organisation may submit a Service Transfer Order at either of the following times:

- for the Original Access Technology, at any time while that Premises remains Serviceable by the Original Access Technology, provided there are no existing in-flight connect orders in respect of the relevant Subsequent Access Technology at that Premises; or
- for the Subsequent Access Technology, once the relevant Fibre Connect Connection has been completed.

The different types of Service Transfers Orders are summarised in the table below and described in this section 4.5.2.6 [Service Transfer Orders](#).

Service Transfer Order type ...	Service Transfer Order can be placed if your organisation is ...
Service Transfer	Gaining RSP
Connect Outstanding Transfer	Gaining RSP
Transfer Reversal	Losing RSP



Important: Where your organisation is the Losing RSP in respect of a service transfer or connect outstanding transfer placed by an Other Gaining RSP, your organisation authorises **nbn** to cause that transfer to occur in accordance with section 12 of the [Service Terms for the **nbn**® Platform Interfacing Service](#).



Important: If your organisation submits a Service Transfer Order in respect of an **nbn**[®] Ethernet (Wireless) ordered product supplied to an Other RSP and, in doing so, wishes to modify the AVC TC-4 bandwidth profile to Fixed Wireless Home Fast from any other bandwidth profile or Fixed Wireless Superfast from any other bandwidth profile, and a W-NTD Upgrade Installation is required for the relevant Premises, your organisation must:

- submit the Service Transfer Order in respect of the **nbn**[®] Ethernet (Wireless) ordered product, regardless of the bandwidth profile that is being supplied to the Other Losing RSP; and
- then, once the Service Transfer Order is complete, submit a Modify Order for either Fixed Wireless Home Fast or Fixed Wireless Superfast.



Important: Your organisation must not submit a Service Transfer Order for an **nbn**[®] Ethernet (Fibre) or **nbn**[®] Ethernet (HFC) AVC TC-4 bandwidth profile that will involve an NTD Add or NTD Replace.

In those circumstances, your organisation may instead:

- submit a Service Transfer Order for an **nbn**[®] Ethernet (Fibre) or **nbn**[®] Ethernet (HFC) AVC TC-4 bandwidth profile that is supported by an existing NTD installed at that Premises; and
- then, once the Service Transfer Order is complete, submit a Modify Order to upgrade the AVC TC-4 to the desired bandwidth profile.

Overlap Period

The Overlap Period is the period during which two **nbn**[®] Ethernet Products in respect of the same Premises run concurrently during the process of a Service Transfer Order.

An Overlap Period must be nominated when submitting a Service Transfer Order in relation to an access technology for which Overlap Period options are available. Service Transfer Orders support two Overlap Period options:

Overlap Period	Description	Applicable Access Technologies
No Overlap	The services do not run concurrently for any period. If your organisation nominates the “No Overlap” option there will be a service interruption when the Service Transfer Order is processed. This service interruption is not an Outage or a Service Fault.	<ul style="list-style-type: none"> • Fibre Network • Wireless Network • FTTB Network • FTTN Network • FTTC Network • Satellite Network • HFC Network
4 Hour Overlap	The services run concurrently for four hours. Your organisation must nominate an unused UNI port for the Service Transfer Order.	<ul style="list-style-type: none"> • Fibre Network • Wireless Network • Satellite Network

Service Transfer

A Service Transfer involves the transfer of an **nbn**[®] Ethernet Product in respect of a Premises from the Other Losing RSP to your organisation (as the Gaining RSP) using the nominated UNI port (and may include a Non-Infrastructure Type Transfer).

Your organisation may only place a Service Transfer Order requesting a Service Transfer if:

- your organisation is the Gaining RSP;
- your organisation has a valid Customer Authority;
- your organisation has provided **nbn** with a Customer Authority signed date that is neither a future date nor a date that is more than 45 calendar days before the placement of the Service Transfer Order;

- for a Service Transfer Order (other than a Non-Infrastructure Type Transfer) submitted on or after 18 May 2025, your organisation provides to **nbn** the AVC ID of the Ordered Product supplied to the Other Losing RSP that is the subject of the Service Transfer;
- **nbn** has notified your organisation that the Service Transfer is a Blocked Service Transfer, and your organisation has received a notification from the Other Losing RSP or **nbn** (as relevant) that the flag requiring Transfer Validation has been removed from the relevant Premises;
- the relevant **nbn**[®] Ethernet Product is supplied to the Other Losing RSP in respect of a Contracted End User who is the same person as the Contracted End User to whom your organisation or a Downstream Service Provider proposes to supply an RSP Product or Downstream Product (as the case may be); and
- your organisation has nominated an Overlap Period if required.

Upon acceptance of a Service Transfer Order for a Service Transfer, **nbn** will:

- disconnect or otherwise cease supplying to the nominated UNI port the existing **nbn**[®] Ethernet Product supplied to the Other Losing RSP;
- activate in accordance with this section [4.5.2.6 Service Transfer Orders](#) a new **nbn**[®] Ethernet Ordered Product for your organisation using the nominated UNI port; and
- provide a Transfer Loss Notification to the Other Losing RSP and a Completed Notification to your organisation.



Important: If your organisation submits a Service Transfer Order in respect of an **nbn**[®] Ethernet (Fibre) ordered product supplied to an Other Losing RSP that includes a UNI-V, the UNI-V supplied to the Other Losing RSP will be disconnected and the **nbn**[®] Ethernet Ordered Product activated for your organisation will not include a UNI-V.

Connect Outstanding Transfer

A Connect Outstanding Transfer involves the transfer of an **nbn**[®] Ethernet Product in respect of a Premises from the Other Losing RSP to your organisation (as the Gaining RSP) using the nominated UNI port in circumstances where:

- the **nbn**[®] Ethernet Product supplied to the Other Losing RSP has not been disconnected; and
- the Contracted End User of the existing service to be transferred is not the same as the Contracted End User who has provided a Customer Authority to your organisation.

Note: A Connect Outstanding Transfer may be available where a Contracted End User has vacated the relevant premises but the service supplied to that Contracted End User has not been disconnected.

The AVC ID or last 5 digits of the AVC ID is not required to be supplied with a Connect Outstanding Transfer Order.

Your organisation may only place a Service Transfer Order requesting a Connect Outstanding Transfer if:

- your organisation is the Gaining RSP;
- your organisation has a valid Customer Authority;
- the relevant **nbn**[®] Ethernet Product is supplied to the Other Losing RSP in respect of a contracted end user who is not the same person as the Contracted End User to whom your organisation or a Downstream Service Provider proposes to supply an RSP Product or Downstream Product (as the case may be); and
- your organisation has nominated an Overlap Period if required

By submitting a Service Transfer Order requesting a Connect Outstanding Transfer, your organisation warrants that it has complied with its obligations under the Connect Outstanding Code (where applicable).

Upon acceptance of a Service Transfer Order for a Connect Outstanding Transfer, **nbn** will:

- disconnect or otherwise cease supplying to the nominated UNI port the existing **nbn**[®] Ethernet Product supplied to the Other Losing RSP;

- activate in accordance with this section [4.5.2.6 Service Transfer Orders](#), a new **nbn**[®] Ethernet Ordered Product for your organisation using the nominated UNI port; and
- provide a Transfer Loss Notification to the Other Losing RSP and a Completed Notification to your organisation.

Transfer Reversal

A Transfer Reversal involves the transfer of an **nbn**[®] Ethernet Product in respect of a Premises from the Other Gaining RSP to your organisation (as the Losing RSP) using the nominated UNI port in circumstances where a service transfer order placed by the Other Gaining RSP under an Other Wholesale Broadband Agreement is unauthorised, was placed in error or is a result of an irregularity.

Your organisation may only place a Service Transfer Order flagged as a Transfer Reversal if your organisation:

- is the Losing RSP for an **nbn**[®] Ethernet Ordered Product which was supplied by **nbn** to your organisation in respect of the relevant Premises;
- reasonably considers that the relevant service transfer order placed by the Other Gaining RSP under an Other Wholesale Broadband Agreement is unauthorised, was placed in error or is a result of an irregularity (including based on information provided by a Contracted End User);
- has received a Transfer Loss Notification in respect of that **nbn**[®] Ethernet Ordered Product and submits a Service Transfer Order requesting a Transfer Reversal within 20 Business Days of receiving the Transfer Loss Notification (or such longer period agreed with **nbn**); and
- has nominated an Overlap Period if required

If your organisation places a Service Transfer Order for a Transfer Reversal within 20 Business Days of receiving the Transfer Loss Notification (or such longer period agreed with **nbn**) then, upon acceptance of that Service Transfer Order, **nbn** will:

- disconnect or otherwise cease supplying the new **nbn**[®] Ethernet Product to the Other Gaining RSP using the nominated UNI port in respect of the relevant Premises;
- activate in accordance with this section [4.5.2.6 Service Transfer Orders](#), the **nbn**[®] Ethernet Ordered Product previously supplied to your organisation using the nominated UNI port; and
- provide a Transfer Loss Notification to the Other Gaining RSP and a Completed Notification to your organisation.



Important: Any Service Transfer Order for a Transfer Reversal requested later than 20 Business Days after your organisation receives a Transfer Loss Notification requires escalation via the relevant email address for your organisation as specified in the *Contact Matrix*. **nbn** will then advise how this Service Transfer Order will be processed.

nbn may charge your organisation for placing a Transfer Reversal, as specified in the [nbn[®] Ethernet Price List](#).

nbn is not responsible for the completion of the original order for a service transfer or transfer reversal. Your organisation must take steps, if desired, to settle any dispute with the Other RSP.

The AVC ID or last 5 digits of the AVC ID is not required to be supplied with a Transfer Reversal Order.

Local Number Portability

Local Number Portability (LNP) occurs via a separate process which does not form part of the **nbn**[®] Service Transfer process. Where your organisation indicates in a Service Transfer Order that it is using the LNP process in connection with a Service Transfer, **nbn** will only accept the Service Transfer Order if it is submitted within the processing hours of 8:00am to 4:00pm Australian Eastern Time on Business Days. Service Transfer Orders with LNP selected that are received outside of these processing hours described will be queued until the next processing hour.



Important: Where a Service Transfer Order with LNP selected:

- relates to **nbn**[®] Ethernet (FTTB) or **nbn**[®] Ethernet (FTTN); and
- is received outside of the LNP processing hours,

nbn may reject the Service Transfer Order until such date as notified to your organisation and following the date of that notification, such Service Transfers Orders will be queued until the next processing hour.

Service Transfer and Stability Profile



This section applies to Access Component orders for **nbn**[®] Ethernet (FTTB) or **nbn**[®] Ethernet (FTTN).

If the service is in Repair Profile, this will not change as a result of a Service Transfer Order.

4.5.2.7 **nbn**[®] Building Entry Service (Type 1 Facilities)

Note: The order status process set out in this section [4.5.2.7 **nbn**[®] Building Entry Service \(Type 1 Facilities\)](#), is an exception to the order status life-cycle set out in section [4.5.1.6 Order Status Life-cycle](#).

This section applies to orders for the **nbn**[®] Building Entry Service.



Important: Subject to the [Service Description for the Facilities Access Service](#), your organisation must install cables in accordance with all of the following:

- The terms of the order for the Facilities Access Service accepted by **nbn**
- The Duct Allocation Design approved by **nbn**
- Any directions or conditions that may be given by **nbn** to your organisation in relation to the performance of the installation.

nbn will provide your organisation's Authorised Persons with access to those parts of the Type 1 Facility that are necessary for your organisation to perform the installation (subject to your organisation separately complying with the requirements for physical access to the relevant Type 1 Facility, as set out in Module 3).

Preliminary order assessment

After receipt of a valid order, **nbn** will update the order status to '**Acknowledged**' and conduct a preliminary assessment of the order to determine whether the order is preliminary approved or rejected.

On completion of the preliminary approved order assessment, **nbn** will reserve the relevant duct space (pending final approval or rejection of the order by **nbn** following the Feasibility Study), **nbn** will update the Order status to "In Progress" and provide your organisation with the following preliminary information:

- An indication of whether the access requested appears technically feasible and, if not, whether any reasonable alternative access may be technically feasible (see '[Order Feasibility Check](#)' section below)
- (*Where access is preliminary approved as technically feasible*):
 - Duct Allocation Design containing cable design and duct plans for the most practical route (including distances)
 - Allocation of ducts in/out of each relevant starter pipe/duct or **nbn**[®] Pit(s) (other than an **nbn**[®] starter pipe/duct)
 - Where relevant, recommended **nbn**[®] pit break-out points, including physical directions
 - Building entry diversity details.

If the order is rejected at this preliminary assessment stage because the access requested does not appear to be technically feasible, **nbn** will update the order status to '**Rejected**' and use reasonable endeavours to inform your organisation whether any reasonable alternative access may be technically feasible.

Order Feasibility Check

After preliminary order assessment approval for an **nbn**[®] Building Entry Service order, **nbn** will complete an order feasibility check, including a detailed study in relation to the technical feasibility of that order (**Feasibility Study**) and provide the results of that Feasibility Study to your organisation:

Feasibility Study Results	nbn's Action
Technically Feasible	<p>nbn accepts your organisation's order for the nbn[®] Building Entry Service and will notify your organisation of the following:</p> <ul style="list-style-type: none"> that it is technically feasible to complete the order any conditions which must be satisfied before nbn will commence supplying the nbn[®] Building Entry Service. <p>Your organisation may install lead-in or backhaul transmission cables subject to satisfying any conditions notified by nbn.</p>
Not Technically Feasible	<p>If nbn determines that completing the order is not technically feasible, nbn will update the order status to 'Rejected', along with the reasons why the order has been rejected and use reasonable endeavours to inform your organisation whether any reasonable alternate access may be technically feasible.</p>

If **nbn** determines that the order is technically feasible, your organisation must commence the works within 30 Business Days from the date on which **nbn** provides the results of the Feasibility Study to your organisation.

Post-Installation Quality Audit and Inspection

Your organisation must provide the As Built Drawings to **nbn** as soon as possible after completing the installation of your organisation's lead-in or backhaul transmission cables.

After your organisation completes the installation and provides the As Built Drawings to **nbn**, **nbn** will perform a Post-Installation Audit and Inspection (prior to connection to the **nbn**[®] ODF). The Charges for a Post-Installation Audit and Inspection (if any) are set out in the [Facilities Access Service Price List](#).

nbn will inform your organisation of the date and time on which **nbn** will perform the Post-Installation Audit and Inspection.

Your organisation may observe **nbn**'s performance of a Post-Installation Audit and Inspection provided that your organisation has informed **nbn** of that preference at the time at which your organisation placed the order for the **nbn**[®] Building Entry Service.

If **nbn** identifies any defects in relation to the installation, your organisation must rectify those defects as soon as possible, and in any event prior to placing an order for ODF Termination, following which **nbn** may then perform another Post-Installation Audit and Inspection.

nbn will update the **nbn**[®] Building Entry Service order status to '**Complete**' following the Post-Installation Audit and Inspection if it does not identify any defects in relation to the installation. **nbn** will then archive the As Built Drawings provided by your organisation.

4.5.2.8 Amending a Connect Order (**nbn**[®] Building Entry Service)

A Connect Order for the **nbn**[®] Building Entry Service cannot be amended. If your organisation needs to amend a Connect Order for the **nbn**[®] Building Entry Service, it must cancel the order in accordance with section [4.5.2.9 Cancelling a Connect Order \(**nbn**[®] Building Entry Service\)](#) below, and submit a new order in accordance with section [4.5.2.6 Service Transfer Orders](#).

4.5.2.9 Cancelling a Connect Order (**nbn**[®] Building Entry Service)

Your organisation may cancel a Connect Order for the **nbn**[®] Building Entry Service at any time before the Point of No Return (see section [4.5.1.4 Point of No Return](#)) by doing all of the following:

- Completing all relevant fields of the Building Entry Services Cancellation Request Form (which will be provided on request)
- Emailing a scanned copy of the completed document to: FacilitiesAccess@nbnco.com.au.

4.5.3 Enhanced Fault Rectification Service

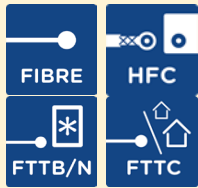

Important: This section applies to **nbn**® Ethernet (Fibre), **nbn**® Ethernet (HFC), **nbn**® Ethernet (FTTB), **nbn**® Ethernet (FTTN) and **nbn**® Ethernet (FTTC).

If your organisation proposes to use an RSP Product or Downstream Product in the following manner, then your organisation must do all the things set out in the table below:

Current use of the relevant RSP Product or Downstream Product		Proposed use of the relevant RSP Product or Downstream Product	Activities to take in respect of the relevant RSP Product or Downstream Product
Downstream Priority Assistance Service	Enhanced Fault Rectification Service		
Yes	No	Enhanced Fault Rectification Service	<ul style="list-style-type: none"> • Must submit a Modify Order in accordance with section 4.5.4 Modify Orders, which adds the Enhanced Fault Rectification Service; and • Cease using (or procure that Downstream Service Provider ceases using) that Ordered Product as an input into the supply of a Downstream Priority Assistance Service prior to the date that your organisation proposes to use the Enhanced Fault Rectification Service in respect of the Ordered Product.
No	Yes	Downstream Priority Assistance Service	<ul style="list-style-type: none"> • Must submit a Modify Order in accordance with section 4.5.4 Modify Orders to remove the Enhanced Fault Rectification Service.

4.5.4 Modify Orders

Your organisation may make modifications and other changes to the features or current configuration of some existing **nbn**® Ethernet and Facilities Access Service Ordered Products by placing a Modify Order through the **nbn**® Service Portal or B2B Access. There are limits to what can be modified; see section 4.5.4.1 [Permitted Modifications to Product Components](#) below.



Important: When placing a Modify Order, your organisation must always provide the Product Instance ID for the associated Product Component.





Important: For further information on Modify Orders that relate to a Temporary POI Migration Order (including the modification of any Product Components as part of the migration of an AVC or CVC from a Temporary POI to an Established POI), see section 4.5.6 [Temporary POI Migration Orders](#).



4.5.4.1 Permitted Modifications to Product Components

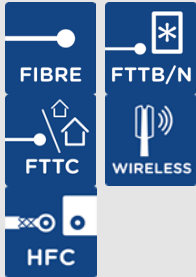

The following table describes the modifications and other changes your organisation is permitted to make to existing Product Components and requirements your organisation must comply with.



Product component	Allowable Modifications and supporting notes; requirements
nbn® Building Entry Service	<p><i>Modification not permitted – additional order required</i></p> <p>To modify a Connect Order for the nbn® Building Entry Service your organisation must cancel the order in accordance with section 4.5.1.3 Cancelling Orders, and submit a new order in accordance with section 4.5.2 Connect Orders.</p>
ODF Termination	<p><i>Modification not permitted - additional order required</i></p> <p>To order an additional ODF Termination, your organisation must place a new order through the nbn® Service Portal; see section 4.5.2 Connect Orders.</p>
Co-location	<ul style="list-style-type: none"> Fibre Tie Cables; see sections 4.3.6.1 and 4.3.6.4 of the Facilities Access Service – Service Technical Specification To order additional Equipment Racks, your organisation must place a new order through the nbn® Service Portal; see section 4.5.2 Connect Orders.
Cross Connect	<ul style="list-style-type: none"> The From position of the Cross Connection The To position of the Cross Connection <p>Where the From or To position is a designated ODF Termination Point of any Other RSP, your organisation must provide a separate Cross Connect Authorisation Form for each Cross Connection within the Modify Order.</p> <p>Your organisation must email the completed Cross Connect Authorisation Forms to the email address as specified in the Contact Matrix.</p> <div style="background-color: #ffffcc; padding: 5px;"> <p> Important: Include the reference ID with both the Cross Connect order and the Cross Connect Authorisation Form.</p> </div>
Network-Network Interface (NNI)	<p>The following transaction is a permitted NNI Modification: Tag Protocol Identifier (TPID)</p> <p>In addition, the following transactions (which are not NNI Modifications) may also be requested by your organisation by submitting a Modify Order in the nbn® Service Portal:</p> <ul style="list-style-type: none"> replacement of an NNI Bearer with an NNI Bearer with a different interface type (optics) (which comprises the disconnection of the relevant NNI Bearer and the subsequent Activation of an NNI Bearer with the new interface type) Activation of NNI Bearers to be added to an existing NNI Group disconnection of NNI Bearers (without disconnecting the NNI Group) NNI Upsize Migrations NNI Diversity Upgrades <p>Any associated Charges are set out in the nbn® Ethernet Price List.</p> <p><i>Disruptions</i></p> <p>If nbn determines that a Modify Order relating to an NNI is likely to cause disruption to services provided using the affected NNIs, nbn will fulfil the order during the following hours:</p> <ul style="list-style-type: none"> Thursday 24:00 hours (midnight) to Friday 06:00 hours (6am) Friday 24:00 hours (midnight) to Saturday 06:00 hours (6am) Saturday 24:00 hours (midnight) to Sunday 06:00 hours (6am). <p><i>Planned Maintenance</i></p>

Product component	Allowable Modifications and supporting notes; requirements
	<p>A Modify Order relating to an NNI may require a Planned Outage. Where a Planned Outage is required, nbn will notify your organisation as described in section 5.5.1.3 Planned Outage Notice: Contents.</p> <p><i>Coordination with V-NNI RSPs</i></p> <p>Your organisation will be responsible for coordinating with any V-NNI RSPs in relation to any impacts that a Modify Order may have on any Downstream V-NNIs and associated ordered products supplied to those V-NNI RSPs. However, where a Modify Order requires an NNI Migration Outage, nbn will also issue a Planned Outage Notice to each affected V-NNI RSP.</p> <p><i>NNI Diversity Upgrades (Single Chassis to Diverse Chassis)</i></p> <p>An NNI Diversity Upgrade comprises the following activities in respect of an NNI Group located at an Upgraded POI that is configured in Single Chassis mode:</p> <ul style="list-style-type: none"> • the Activation of a number of additional NNI Bearers to be added to that NNI Group that is equal to the number of NNI Bearers currently forming part of that NNI Group; and • the reconfiguration of the redundancy mode of that NNI Group from Single Chassis to Diverse Chassis mode. <p>Example: For an NNI Group with two 1G NNI Bearers configured in Single Chassis mode, an NNI Diversity Upgrade may be submitted for the Activation of two additional 1G NNI Bearers and the reconfiguration of the redundancy mode, resulting in an NNI Group with two pairs of 1G NNI Bearers configured in Diverse Chassis mode.</p> <p>Your organisation may only request an NNI Diversity Upgrade in respect of an NNI Group if:</p> <ul style="list-style-type: none"> • the NNI Group is: <ul style="list-style-type: none"> ○ configured in Single Chassis operating mode; ○ located at an Upgraded POI; and ○ not associated with nbn[®] Ethernet (Satellite) CVCs or AVCs or nbn[®] Enterprise Ethernet OVCs with Route Aggregation; and • the request would result in the NNI Group having no more than: <ul style="list-style-type: none"> ○ four pairs of 1G NNI Bearers configured in Diverse Chassis mode; ○ four pairs of 10G NNI Bearers configured in Diverse Chassis mode; or ○ two pairs of 100G NNI Bearers configured in Diverse Chassis mode. <p>Where an NNI Diversity Upgrade is not available, your organisation cannot order a modification to an existing Single Chassis NNI to change it to a Diverse Chassis NNI. Instead, in those circumstances, your organisation must place a new order for a Diverse Chassis NNI.</p> <p>Note: If an NNI Group is not eligible for an NNI Diversity Upgrade because the NNI Diversity Upgrade would otherwise result in the NNI Group having more pairs of NNI Bearers than permitted, your organisation may consider submitting an NNI Upsize Migration or Modify Order first in order to reduce the number of NNI Bearers in that NNI Group and become eligible to request an NNI Diversity Upgrade.</p> <p><i>NNI Upsize Migrations</i></p> <p>An NNI Upsize Migration comprises the following:</p> <ul style="list-style-type: none"> • the Activation of an NNI Group (Target NNI Group) at an Upgraded POI; • the migration, from an NNI Group that is already being supplied to your organisation at the same Upgraded POI at the time the NNI Upsize Migration is requested (Source NNI Group) to the Target NNI Group, of all AVCs, CVCs, OVCs, V-NNIs and NNI Links associated with the Source NNI Group; and

Product component	Allowable Modifications and supporting notes; requirements										
	<ul style="list-style-type: none"> the disconnection of the Source NNI Group once all AVCs, CVCs, OVCs, V-NNIs and NNI Links associated with the Source NNI Group have been migrated to the Target NNI Group. <p>Your organisation may only request an NNI Upsize Migration if:</p> <ul style="list-style-type: none"> the Source NNI Group comprises one of the NNI Bearer combinations set out in the "Source NNI Group" column in the table below; the Target NNI Group comprises a corresponding NNI Bearer combination set out in the same row, in the "Target NNI Group" column in the table below; and both the Source NNI Group and Target NNI Group are configured in the same redundancy mode (Single Chassis or Diverse Chassis). <table border="1" data-bbox="389 528 1460 963"> <thead> <tr> <th data-bbox="389 528 922 582">Source NNI Group</th> <th data-bbox="922 528 1460 582">Target NNI Group</th> </tr> </thead> <tbody> <tr> <td data-bbox="389 582 922 689">Up to eight 1G NNI Bearers configured in Single Chassis mode</td> <td data-bbox="922 582 1460 689">Up to eight 10G NNI Bearers, or up to two 100G NNI Bearers, configured in Single Chassis mode</td> </tr> <tr> <td data-bbox="389 689 922 797">Up to four pairs of 1G NNI Bearers configured in Diverse Chassis mode</td> <td data-bbox="922 689 1460 797">Up to four pairs of 10G NNI Bearers, or up to two pairs of 100G NNI Bearers, configured in Diverse Chassis mode</td> </tr> <tr> <td data-bbox="389 797 922 882">Up to eight 10G NNI Bearers configured in Single Chassis mode</td> <td data-bbox="922 797 1460 882">Up to two 100G NNI Bearers configured in Single Chassis mode</td> </tr> <tr> <td data-bbox="389 882 922 963">Up to four pairs of 10G NNI Bearers configured in Diverse Chassis mode</td> <td data-bbox="922 882 1460 963">Up to two pairs of 100G NNI Bearers configured in Diverse Chassis mode</td> </tr> </tbody> </table>	Source NNI Group	Target NNI Group	Up to eight 1G NNI Bearers configured in Single Chassis mode	Up to eight 10G NNI Bearers, or up to two 100G NNI Bearers, configured in Single Chassis mode	Up to four pairs of 1G NNI Bearers configured in Diverse Chassis mode	Up to four pairs of 10G NNI Bearers, or up to two pairs of 100G NNI Bearers, configured in Diverse Chassis mode	Up to eight 10G NNI Bearers configured in Single Chassis mode	Up to two 100G NNI Bearers configured in Single Chassis mode	Up to four pairs of 10G NNI Bearers configured in Diverse Chassis mode	Up to two pairs of 100G NNI Bearers configured in Diverse Chassis mode
Source NNI Group	Target NNI Group										
Up to eight 1G NNI Bearers configured in Single Chassis mode	Up to eight 10G NNI Bearers, or up to two 100G NNI Bearers, configured in Single Chassis mode										
Up to four pairs of 1G NNI Bearers configured in Diverse Chassis mode	Up to four pairs of 10G NNI Bearers, or up to two pairs of 100G NNI Bearers, configured in Diverse Chassis mode										
Up to eight 10G NNI Bearers configured in Single Chassis mode	Up to two 100G NNI Bearers configured in Single Chassis mode										
Up to four pairs of 10G NNI Bearers configured in Diverse Chassis mode	Up to two pairs of 100G NNI Bearers configured in Diverse Chassis mode										
<p>Connectivity Virtual Circuit (CVC)</p> 	<ul style="list-style-type: none"> CVC bandwidth profile (TC-1, TC-2 and TC-4) Other modifications, as set out by nbn from time to time in the <i>nbn[®] Operations User Guide</i>. 										
<p>Connectivity Virtual Circuit (CVC)</p> 	<ul style="list-style-type: none"> CVC bandwidth profile (TC-1 and TC-4). Other modifications, as set out by nbn from time to time in the <i>nbn[®] Operations User Guide</i>. <p><i>CVC Class modification</i></p> <p>To modify the CVC Class of a CVC TC-4 Product Component of the nbn[®] Ethernet (Satellite), your organisation must place a Connect Order for a new CVC with the desired CVC Class.</p> <p>At the completion of this order, your organisation may associate existing AVCs with the new CVC by placing a Modify Order for those AVCs.</p> <p>Upon completion of the Modify Orders for those AVCs, your organisation may choose to place a Disconnect Order for the previous CVC in accordance with section 4.5.5 Disconnect Orders.</p> <p>Refer to the nbn[®] Ethernet Product Description and the nbn[®] Ethernet Fair Use Policy for further information regarding permitted modifications to CVCs in connection with nbn[®] Ethernet (Satellite).</p> <p><i>CVC downgrades</i></p> <p>Your organisation must associate at least the minimum number of AVCs with each ordered CVC TC-1 or CVC TC-4 for nbn[®] Ethernet (Satellite) as set out in the nbn[®] Ethernet Product Description.</p>										

Product component	Allowable Modifications and supporting notes; requirements
	<p>CVC TC-1</p> <p>If the number of AVCs that your organisation has associated with a particular CVC TC-1 is less than the relevant CVC Class threshold set out in section 2.3(c) of the nbn® Ethernet Product Description, nbn may contact your organisation and request the CVC TC-1 bandwidth profile to be reduced. Following three separate requests, nbn will downgrade the bandwidth profile of the CVC TC-1 to comply with the applicable CVC Class threshold in the nbn® Ethernet Product Description and will provide your organisation with a notification to confirm the new CVC TC-1 bandwidth profile.</p> <p>CVC TC-4</p> <p>If the number of AVCs that your organisation has associated with a particular CVC TC-4 is less than the relevant CVC Class threshold set out in section 2.2(e)(iii) of the nbn® Ethernet Product Description by 50 AVCs or more, nbn will send up to three notifications within a 7 calendar day period to indicate that the CVC bandwidth profile should be reduced. Each notification will include:</p> <ul style="list-style-type: none"> • The date that the number of provisioned AVCs fell below the relevant CVC Class threshold • The date by which the CVC bandwidth profile must be reduced to comply with the relevant CVC Class threshold. <p>If your organisation fails to reduce the relevant CVC bandwidth profile by the notified date, nbn may initiate a Modify Order to automatically reduce the CVC TC-4 bandwidth profile to comply with the applicable CVC Class threshold in the nbn® Ethernet Product Description.</p> <p>Once the Modify Order has been completed, nbn will provide your organisation with a further notification to confirm the new CVC TC-4 bandwidth profile.</p> <p>Your organisation will be responsible for configuring its CVC interface in its RSP Network and RSP Platform to align with any modified CVC bandwidth profile notified by nbn to avoid any associated performance issues.</p>
<p>Access Components</p> 	<p>For AVCs and UNI-Ds:</p> <ul style="list-style-type: none"> • Modification of the AVC • Traffic class • Removal of Battery Backup Service via either a Transition-out Modify Order or a Disconnect Order • Other modifications, as set out by nbn from time to time in the <i>nbn® Operations User Guide</i>. <p><i>Modification of AVC bandwidth profile (no NTD Replace)</i></p> <p>If a Modify Order is in respect of a modification between the following sets of AVC TC-4 bandwidth profiles: 12/1 Mbps, 25/5 Mbps, 25/10 Mbps, 50/20 Mbps, 100/40 Mbps, Home Fast, 250/100 Mbps, 500/200 Mbps, 1000/400 Mbps, Home Superfast, Home Ultrafast, Home Hyperfast or 2000/500 Mbps, there will be a brief service interruption (typically lasting less than 1 minute) when the Modify Order is processed. Modify Orders of this nature are usually processed by nbn within 10 minutes after your organisation places the order (whether such order is placed during or outside Business Hours). This brief service interruption is not an Outage or a Service Fault.</p> <p><i>Modification Order involving NTD Replace</i></p> <p>If a Modify Order is in respect of a modification between AVC TC-4 bandwidth profiles, and nbn performs an NTD Replace as part of that Modify Order the process and requirements described in section 4.5.4.2 Interactions: Modify Order applies.</p> <div style="border: 1px solid #ccc; padding: 10px; margin-top: 10px;"> <p> Important: Your organisation must not request an NTD Add as part of a Modify Order.</p> </div>
<p>Access Components</p>	<ul style="list-style-type: none"> • Traffic class • Change of bandwidth profile • Other modifications, as set out by nbn from time to time in the <i>nbn® Operations User Guide</i>.

Product component	Allowable Modifications and supporting notes; requirements
	<p><i>Modification of AVC bandwidth profile (no W-NTD Upgrade Installation)</i></p> <p>If a Modify Order is in respect of a modification between AVC TC-4 bandwidth profiles, and a W-NTD Upgrade Installation is not required, there may be a brief service interruption (typically lasting less than 3 minutes) when the Modify Order is processed. Modify Orders of this nature are usually processed by nbn within 10 minutes after your organisation places the order (whether such order is placed during or outside Business Hours). This brief service interruption is not an Outage or a Service Fault.</p> <p><i>Modification Order involving W-NTD Upgrade Installation</i></p> <p>If a Modify Order is in respect of a modification between AVC TC-4 bandwidth profiles, and a W-NTD Upgrade Installation is required:</p> <ul style="list-style-type: none"> the process and requirements described in section 4.5.4.2 Interactions: Modify Order applies there will be a brief service interruption (typically lasting 60 minutes or less) when the W-NTD Upgrade Installation is being performed. This brief service interruption is not an Outage or a Service Fault.
<p>Access Components</p> 	<p>For AVCs and UNI-DSLs:</p> <ul style="list-style-type: none"> Bandwidth profile (TC-1, TC-2 and TC-4) CVC C-TAG Professional Wiring Service (described in section 4.5.2.1 Interactions: Connect Order) Other modifications, as set out by nbn from time to time in the nbn® Operations User Guide. <p><i>Modification of AVC bandwidth profile only (no Professional Wiring Service)</i></p> <p>If a Modify Order is in respect of a modification between the following sets of AVC TC-4 bandwidth profiles: 12/1 Mbps, 25/5 Mbps, 25/5-10 Mbps, 25-50/5-20 Mbps, 25-100/5-40 Mbps, or Home Fast, there will be a brief service interruption (typically lasting less than 1 minute) when the Modify Order is processed. This brief service interruption is not an Outage or a Service Fault. Modify Orders of this nature are usually processed by nbn within 10 minutes after your organisation places the order (whether or not such order is placed during or outside Business Hours).</p> <p><i>Modification Order involving Professional Wiring Service</i></p> <p>When your organisation requests a Professional Wiring Service in respect of a Service Class 13 nbn® Copper Pair, the process and requirements described in section 4.5.2.1 Interactions: Connect Order that applies to Professional Wiring Service in respect to Connect Orders for a Premises applies.</p>
<p>Access Components</p> 	<p>For AVCs and UNI-Ds:</p> <ul style="list-style-type: none"> Bandwidth profile (TC-1, TC-2 and TC-4) CVC C-TAG Professional Wiring Service (Service Class 34) (described in section 4.5.2.5 Professional Wiring Service (optional)) Other modifications, as set out by nbn from time to time in the nbn® Operations User Guide. <p><i>Modification of AVC bandwidth profile only (no Professional Wiring Service)</i></p> <p>If a Modify Order is in respect of a modification between the following sets of AVC TC-4 bandwidth profiles: 12/1 Mbps, 25/5 Mbps, 25/5-10 Mbps, 25-50/5-20 Mbps, 50-100/25-40 Mbps, or Home Fast, there will be a brief service interruption (typically lasting less than 1 minute) when the Modify Order is processed. This brief service interruption is not an Outage or a Service Fault. Modify Orders of this nature are usually processed by nbn within 10 minutes after your organisation places the order (whether or not such order is placed during or outside Business Hours).</p>
<p>Access Components</p>	<p>For AVCs:</p> <ul style="list-style-type: none"> Change of C-TAG Change of bandwidth profile

Product component	Allowable Modifications and supporting notes; requirements
	<ul style="list-style-type: none"> • Change of TPEP configuration • Change of CVC • Access Loop Identification mode and Access Loop Identification label • AC/DC power supply • Other modifications, as set out by nbn from time to time in the <i>nbn® Operations User Guide</i>. <p>Refer to the nbn® Ethernet Product Description and the nbn® Ethernet Fair Use Policy for further information regarding permitted modifications to AVCs in connection with nbn® Ethernet (Satellite).</p> <p><i>Modification of AVC bandwidth profile</i></p> <p>There will be a brief service interruption when the Modify Order is processed if it is in respect of a modification between the following sets of AVC TC 4 bandwidth profiles: 12/1 Mbps and 25/5 Mbps. This brief service interruption is not an Outage or a Service Fault.</p> <p><i>Modification of AC/DC power supply</i></p> <p>To change the power supply between AC and DC for the indoor component of an NTD at a Service Class 9 Premises, your organisation must place a Modify Order through the nbn® Service Portal. nbn may charge your organisation an Equipment Modification (NTD indoor unit) Charge in accordance with the nbn® Ethernet Price List.</p>
Access Components 	<p>For AVCs and UNI-Ds:</p> <ul style="list-style-type: none"> • AVC bandwidth profile Modification • Traffic class • Other modifications, as set out by nbn from time to time in the <i>nbn® Operations User Guide</i>. <p><i>Modification of AVC bandwidth profile (No NTD Replace)</i></p> <p>If a Modify Order is in respect of a modification between:</p> <ul style="list-style-type: none"> • the following sets of AVC TC 4 bandwidth profiles: 12/1 Mbps, 25/5 Mbps, 25/10 Mbps, 50/20 Mbps, 100/40 Mbps, Home Fast, Home Superfast, Home Ultrafast or Home Hyperfast; or • the following sets of AVC TC 2 bandwidth profiles: 5 Mbps and 10 Mbps <p>there will be a brief service interruption (typically lasting less than 1 minute) when the Modify Order is processed. Modify Orders of this nature are usually processed by nbn within 10 minutes after your organisation places the order (whether such order is placed during or outside Business Hours). This brief service interruption is not an Outage or a Service Fault.</p> <p><i>Modification Order involving NTD Replace</i></p> <p>If a Modify Order is in respect of a modification between AVC TC-4 bandwidth profiles, and nbn performs an NTD Replace as part of that Modify Order, the process and requirements described in section 4.5.4.2 Interactions: Modify Order and section 4.6.6 nbn® Ethernet (HFC) Installation Options apply.</p> <div style="border: 1px solid #0070c0; padding: 10px; margin-top: 10px;"> <p> Important: Your organisation must not request an NTD Add as part of a Modify Order.</p> </div>

4.5.4.2 Interactions: Modify Order

The following diagram illustrates the interactions between your organisation and **nbn** that can arise from the submission of a Modify Order.





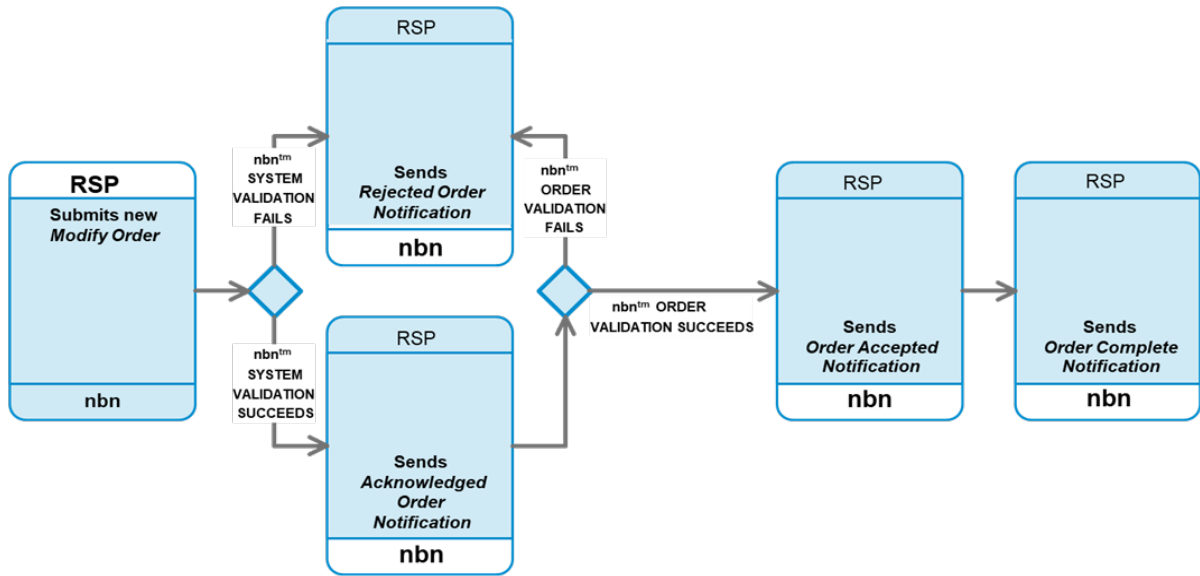

Important: For further information on Modify Orders that relate to a migration of Ordered Products from a Temporary POI to a Permanent POI, see [section 4.5.8 Temporary POI Migration Orders](#).



Description

The following table describes the interaction activities between your organisation and **nbn** that can arise from the submission of a Modify Order.

Who	Activity
Your organisation...	Submits a Modify Order (via the nbn ® Service Portal or B2B Access) against a completed Product order.
nbn...	<p>Confirms that the Modify Order was submitted correctly and depending on the result of the submission validation, does one of the following:</p> <ul style="list-style-type: none"> <i>(If the Modify Order was submitted correctly)</i> Sends your organisation an Acknowledged Notification and updates the Order Status to Acknowledged. The notification includes the Modify Order’s unique Order ID. Note: Your organisation may cancel the order at this time. <i>(If the Modify Order was not submitted correctly)</i> Sends your organisation a Rejected Notification if nbn rejects the order and updates the Order Status to Rejected.
nbn...	<p><i>(If the Modify Order was submitted correctly)</i> Confirms that the specific information provided in the Modify Order is sufficient to proceed with the order and, depending on the result of this validation, does one of the following:</p> <ul style="list-style-type: none"> <i>(If nbn determines that the Modify Order is valid)</i> Sends your organisation an Order Accepted Notification and updates the Order Status to In Progress. The notification includes the Modify Order’s unique Order ID. Note: Your organisation may cancel the order at this time. <div style="background-color: #ffffcc; padding: 10px; border: 1px solid #ccc;">  <p>Important: If a Modify Order for nbn® Ethernet (Satellite) requires an Appointment but your organisation has not reserved an Appointment, nbn will send your organisation a Pending Notification and update the Order Status to Pending. Your organisation must then reserve an Appointment in accordance with section 4.5.2.1 Interactions: Connect Order, section 6.2.5 Appointment Communication Responsibilities, section 6.2.3 Appointment Blocks and section 6.3.2 New Appointment Process.</p> <p>After your organisation has done so, nbn will contact the Appointment Representative to schedule the Actual Appointment and update the Order Status in accordance with section 4.5.2.1 Interactions: Connect Order, section 6.2.5 Appointment Communication Responsibilities, section 6.2.3 Appointment Blocks and section 6.3.2 New Appointment Process.</p> </div>

Who	Activity
	<p> Important: If a Modify Order for an NNI requires your organisation to request a date/time for the activity to be performed, and nbn has determined that the activity can be scheduled on the date requested by your organisation, nbn will schedule the order, change the Order Status to Pending, and nbn will not progress the order further until the Requested Start Date/Time.</p> <p>The Requested Start Date/Time in respect of such an activity must be at least 5 Business Days after the date on which your organisation provides the Requested Start Date/Time.</p> <p>If your organisation requests a start date/time that does not comply with this requirement, nbn will work with your organisation to agree an alternative start date/time, place the Modify Order in a Pending Order Status, and will not process it further until that start date/time.</p> <p>Your organisation must have resources available on the scheduled start date/time to provide any assistance reasonably requested by nbn to enable nbn to perform the Modify Order</p> <p> Important: If a Modify Order for an NNI involves the Activation or disconnection of one or more NNI Bearers, your organisation must separately submit a Connect Order, Modify Order or Disconnect Order (as applicable) for Cross Connects in relation to the relevant NNI Bearers in accordance with the process set out in section 4.5.2.2 Product Component Orders: Additional Information, section 4.5.6.1 Permitted Modifications to Product Components or section 4.5.7 Disconnect Orders (as applicable).</p> <p> Important: If nbn determines that a W-NTD Upgrade Installation or NTD Replace is required, nbn will notify your organisation that an Appointment is required, request your organisation to reserve an Appointment, send your organisation a Pending Notification in respect of the Modify Order and update the Order Status to Pending.</p> <p>Your organisation must then reserve an Appointment in accordance with section 6.3.2 New Appointment Process. Once your organisation has reserved an Appointment in accordance with section 6.3.2 New Appointment Process, the processes relating to Installation Appointments will apply.</p> <ul style="list-style-type: none"> • (If nbn determines that the Modify Order is not valid) Sends your organisation a Rejected Notification and updates the Order Status to Rejected.
nbn...	(On completion of the Modify Order, and subsequent successful testing) Sends your organisation a Completed Notification and updates the Order Status to Complete .

 **Important:** Notes in this section [4.5.4.2 Interactions: Modify Order](#) indicating that your organisation may cancel orders when they have a particular status are subject to time based limitations which apply to order cancellations in some circumstances, as set out in section [4.5.1.4 Point of No Return](#).

4.5.5 Disconnect Orders

If your organisation wishes to disconnect all or part of an **nbn**[®] Ethernet Ordered Product or Facilities Access Service Ordered Product, your organisation must place a Disconnect Order through the **nbn**[®] Service Portal or B2B Access (as applicable).

Order Information

Disconnect Orders must (at the very least) include all of the following:

- A valid Product Instance ID for the Product Component to be disconnected

Note: On disconnection, the Product Instance ID may be deleted by **nbn**.

- All of the information required by the fields in the relevant Disconnect Order form.

Once **nbn** validates a Disconnect Order, **nbn** will process it in accordance with the order stages as described in section 4.5.1.6 Order Status Life-cycle.

Prerequisites for Disconnect Orders

For each of the following Product Components, your organisation must make sure that the applicable disconnection prerequisites below have been met before submitting a Disconnect Order for the Product Component:

Product component	Disconnection prerequisites
nbn® Building Entry Service	nbn has received a valid Disconnect Order, and has completed the Disconnect Order for any associated ODF Termination.
ODF Termination	nbn has received a valid Disconnect Order, and has completed the Disconnect Order for all associated Cross Connects.
Co-location	nbn has received a valid Disconnect Order, and has completed the Disconnect Order for all associated Cross Connects.
Network-Network Interface (NNI)	nbn has received a valid Disconnect Order and Cross Connect Disconnect Order(s), and has completed the Disconnect Order for all associated CVCs and AVCs. Note: Where the NNI is a Linked NNI, nbn has also completed the Modify Order to remove all associated NNI Links.
Connectivity Virtual Circuit (CVC)	nbn has received a valid Disconnect Order, and has completed the Disconnect Orders for all associated AVCs.

Both the **nbn®** Service Portal and B2B Access validate Disconnect Orders against these prerequisites.

Important: If **nbn** disconnects an AVC in response to a Disconnect Order, **nbn** will simultaneously disconnect the associated UNI.

4.5.5.1 Interactions: Disconnect Order

The following diagram illustrates the interactions between your organisation and **nbn** that can arise from the submission of a Disconnect Order.

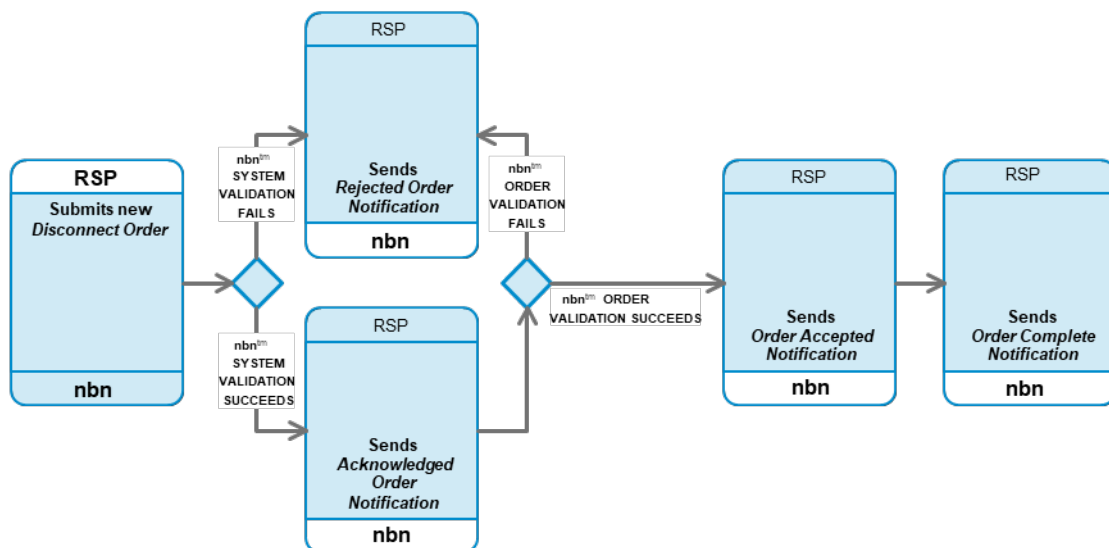

Description

The following table describes the interaction activities between your organisation and **nbn** that can arise from the submission of a Disconnect Order.

Who	Activity
Your organisation...	Submits a Disconnect Order (via the nbn [®] Service Portal or B2B Access) against a completed Product order.
nbn...	Confirms that the Disconnect Order was submitted correctly and depending on the result of the submission validation, does one of the following: <ul style="list-style-type: none"> <i>(If the Disconnect Order was submitted correctly)</i> Sends your organisation an Acknowledged Notification and updates the Order Status to Acknowledged. The notification includes the Disconnect Order's unique Order ID. Note: Your organisation may cancel the order at this time. <i>(If the Disconnect Order was not submitted correctly)</i> Sends your organisation a Rejected Notification if nbn rejects the order and updates the Order Status to Rejected.
nbn...	<i>(If the Disconnect Order was submitted correctly)</i> Confirms that the specific information provided in the Disconnect Order is sufficient to proceed with the order and, depending on the result of this validation, does one of the following: <ul style="list-style-type: none"> <i>(If nbn determines that the Disconnect Order is valid)</i> Sends your organisation an Order Accepted Notification and updates the Order Status to In Progress. The notification includes the Disconnect Order's unique Order ID. Note: Your organisation may cancel the order at this time. <i>(If nbn determines that the Disconnect Order is not valid)</i> Sends your organisation a Rejected Notification and updates the Order Status to Rejected.
nbn...	(On disconnection of the specified services and resources, and the subsequent successful disconnection test) <ul style="list-style-type: none"> Sends your organisation a Completed Notification and updates the Order Status to Complete. Note: The disconnection is effective at this point for the purposes of the definition of Effective Disconnection Date.

4.5.5.2 Access Component Disconnect Orders

If your organisation submits a Disconnect Order for an AVC TC-4 and associated UNI, **nbn** may cancel the supply of any of the following which are supplied to your organisation in connection with the supply of that AVC TC-4 (where applicable):

- AVC TC-1 and associated UNI-V
- AVC TC-2

4.5.5.3 Disconnection as a result of a service transfer order placed by an Other Gaining RSP

Where your organisation is the Losing RSP in respect of a service transfer order placed by an Other Gaining RSP:

- The Ordered Product supplied by **nbn** to your organisation under this Agreement will be disconnected as a result of the service transfer order placed by that Other Gaining RSP;
- Your organisation will receive a Transfer Loss Notification in respect of that service transfer order;
- If your organisation considers that the service transfer order placed by an Other Gaining RSP is unauthorised, was placed in error or is a result of an irregularity, your organisation may submit a Service Transfer Order for a Transfer Reversal in accordance with section 4.5.2.6 [Service Transfer Orders](#); and
- Nothing in this section 4.5.5.3 [Disconnection as a result of a service transfer order placed by an Other Gaining RSP](#) limits any rights your organisation may have against the Other Gaining RSP.

4.5.5.4 Disconnection of UNI-V and Battery Backup Service as a result of an NTD Replace

Where your organisation is acquiring an Ordered Product with a UNI-V, Battery Backup Service, or both, and **nbn** performs an NTD Replace which replaces the installed F-NTD with one that does not have a UNI-V or support a Battery Backup Service:

- Your organisation must submit a Disconnect Order in respect of the UNI-V and Battery Backup Service (as applicable) prior to submitting an order that involves an NTD Replace;
- That UNI-V and Battery Backup Service (as applicable) will be disconnected; and
- Any Power Supply with Battery Backup installed at that Premises will be disconnected and may be removed from the Premises.

4.5.6 Temporary POI Migration Orders



This section applies to **nbn**® Ethernet (Fibre) or **nbn**® Ethernet (Wireless).

nbn will migrate Premises served by a Temporary POI to an Established POI on a per-CSA basis using the Temporary POI Migration Order in respect of **nbn**® Ethernet (Fibre) or **nbn**® Ethernet (Wireless).

4.5.6.1 Temporary POI Migration Cycle by CSA

The following diagram illustrates the timeline for the migration of a Temporary POI to an Established POI on a per-CSA basis:

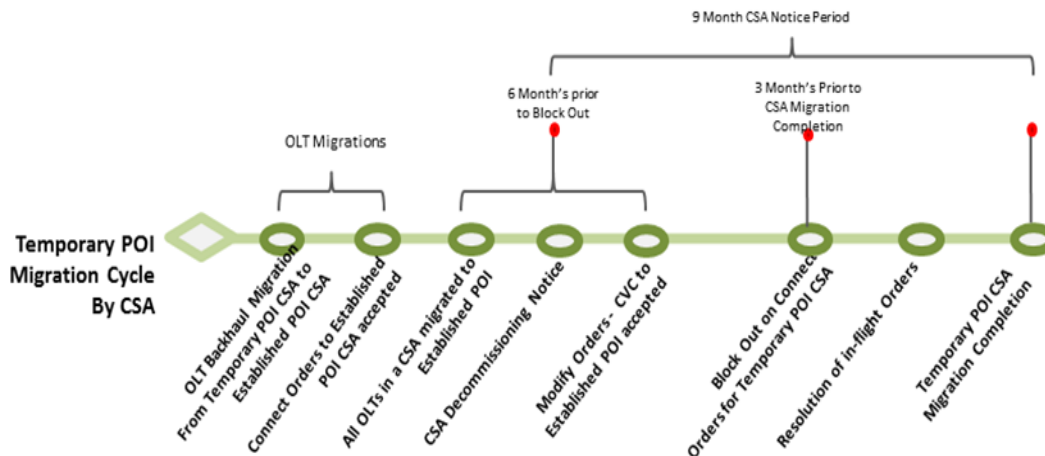

nbn will send your organisation a Temporary POI Decommissioning Notice at least 12 months before commencing the migration of all Premises served by a Temporary POI. The migration process will then continue until all Premises served by that Temporary POI have migrated to one or more Established POIs and the Temporary POI is decommissioned in accordance with clause C14.4 of the [Head Terms](#).

Once a Temporary POI Decommissioning Notice is provided in respect of a particular Temporary POI, **nbn** will use a staged approach to facilitate the migration of AVCs and CVCs from associated Temporary POI CSAs to Established POI CSAs (see section 4.5.6.4 [Staged migration from a Temporary POI to an Established POI](#)).

4.5.6.2 Temporary POI Migration Orders

A Temporary POI Migration Order is a Modify Order for an AVC or CVC where the originating location is a Temporary POI CSA and the destination location is an Established POI CSA (Temporary POI Migration Order).

A Temporary POI Migration Order may be used to undertake any of the following activities:

Activity	Description of activity
Migrate an AVC	The migration of a single AVC (together with a UNI-D and/or UNI-V) from a CVC which serves a Temporary POI CSA to a CVC which serves an Established POI CSA, where the corresponding Premises is associated with both CSAs.
Bulk migration of AVCs	The migration in bulk of multiple AVCs (together with the respective UNI-Ds and/or UNI-Vs) from a CVC which serves a Temporary POI CSA to a CVC which serves an Established POI CSA, where the corresponding Premises are associated with the respective CSAs.
Migrate a CVC	<p>The migration of a CVC associated with a Temporary POI CSA to an Established POI CSA as follows:</p> <ul style="list-style-type: none"> • An update to the associated NNI, from an NNI at a Temporary POI to an NNI at an Established POI • An update to the CSA attribute of the CVC from the Temporary POI CSA to the Established POI CSA.

A Temporary POI Migration Order may also be used to modify existing Product Components as part of the migration of an AVC or CVC from a Temporary POI to an Established POI (see section 4.5.4.1 [Permitted Modifications to Product Components](#)).

A Service Transfer may also be conducted to transfer an existing **nbn**[®] Ethernet Ordered Product supplied to an Other RSP at a Temporary POI to your organisation at an Established POI (see section 4.5.2.6 [Service Transfer Orders](#)).

4.5.6.3 Temporary POI Migration Order Life-cycle

The following diagram illustrates the life-cycle of a Temporary POI Migration Order for the migration of a CVC or the bulk migration of AVCs, including the different Order Status states that may apply:

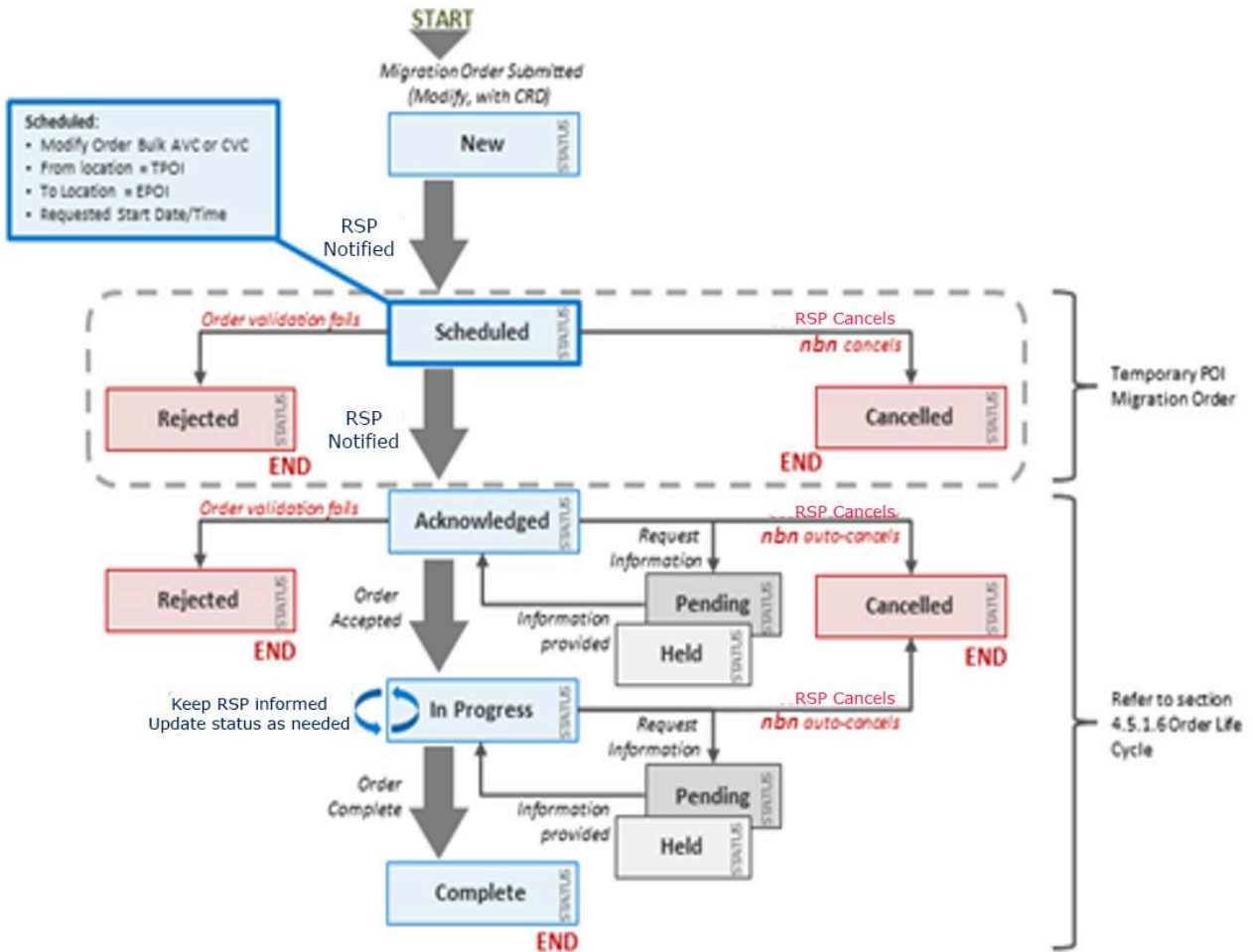

Temporary POI Migration Orders are subject to the standard Order Status states described in section 4.5.1.6 Order Status Life-cycle except as set out below.

An additional Order Status state of “Scheduled” applies for Temporary POI Migration Orders that relate to the migration of CVCs or the bulk migration of AVCs (and any associated UNIs).

Exception: A Temporary POI Migration Order that relates to a single AVC will not be subject to a “Scheduled” Order Status state and will be processed as a standard Modify Order in accordance with section 4.5.1.6 Order Status Life-cycle.

Order Status: Description

The following table defines the Product Components to which the “Scheduled” Order Status can apply and the related activities which must be performed by **nbn** or your organisation in each circumstance.

These activities must be performed once the relevant event set out in the table occurs.

Order Status	Affected Product Component types	Relevant event & activities
Scheduled	<ul style="list-style-type: none"> Connectivity Component Access Component 	<p>Event</p> <p>Your organisation has placed the Temporary POI Migration Order with nbn with the following attributes:</p> <ul style="list-style-type: none"> Requested Start Date/Time Source Site = Temporary POI CSA;

Order Status	Affected Product Component types	Relevant event & activities
		<ul style="list-style-type: none"> • Destination Site = Established POI CSA; and • CVC or bulk AVC Modify Order <p>Activities</p> <p>nbn has received the Temporary POI Migration Order and will not process it further until the Requested Start Date/Time.</p>

4.5.6.4 Staged migration from a Temporary POI to an Established POI

nbn will use a staged approach to facilitate the migration of AVCs and CVCs from associations with Temporary POIs to associations with Established POIs.

nbn will notify your organisation when a new Established POI CSA becomes available via the **Historical Rollout Region List**. The Temporary POI CSA for each affected Premises will continue to be listed as the "Transitional CSA" for a period after that date as described below. On and from the date of such notice, your organisation may place a Temporary POI Migration Order to:

- modify AVCs associated with a CVC (on a single AVC or bulk AVC basis) that serves the Temporary POI CSA to be associated with a CVC that serves the Established POI CSA; or
- modify a CVC serving the Temporary POI CSA to instead serve a relevant Established POI CSA.

nbn will provide at least 6 months' prior written notice to your organisation of the commencement of the Block-Out Period in respect of that Temporary POI CSA (see section 4.5.6.6 [Block-Out Period for Temporary POI CSAs](#)). This notification will also provide at least nine months' notification of the decommissioning of the Temporary POI CSA.



Important: The notification described in this section 4.5.6.4 [Staged migration from a Temporary POI to an Established POI](#) is not a Temporary POI Decommissioning Notice. A separate Temporary POI Decommissioning Notice will be provided by **nbn** in accordance with clause C14.4 of the [Head Terms](#).

4.5.6.5 Orders in respect of Established POIs

See section 4.3.1 [Site Qualification Enquiries](#) for information on updates to the **Historical Rollout Region List** with respect to Temporary POI Migrations.

From the date that the **Historical Rollout Region List** includes an Established POI CSA until the date on which a Block-Out Period commences in respect of the corresponding Temporary POI CSA, your organisation may submit:

- a Connect Order in relation to a Premises to be served by either the Established POI or Temporary POI associated with that Premises
- a Temporary POI Migration Order in relation to a Premises served by a Temporary POI, to migrate that Premises to an Established POI in accordance with 4.5.6.2 [Temporary POI Migration Orders](#).

4.5.6.6 Block-Out Period for Temporary POI CSAs

Upon commencement of the Block-Out Period in respect of a Temporary POI CSA, **nbn** will update the **Historical Rollout Region List** to remove references to that Temporary POI CSA. Your organisation will no longer be able to place a Connect Order for a Product in respect of a Temporary POI CSA once that CSA has been removed from the **Historical Rollout Region List**.

The duration of the Block-Out Period is 3 months.

Your organisation may still place a Modify Order (including a Temporary POI Migration Order) or Disconnect Order in accordance with this [WBA Operations Manual](#) in respect of an Ordered Product associated with a Temporary POI CSA during a Block-Out Period.

nbn will supply any CVC associated with a Temporary POI CSA until the earliest of:

- the migration of the CVC in accordance with 4.5.6.2 [Temporary POI Migration Orders](#)
- the CVC is disconnected by your organisation
- the end of the Block-Out Period for the relevant Temporary POI CSA, at which time **nbn** will disconnect the CVC.

4.5.7 Same POI Migration Orders

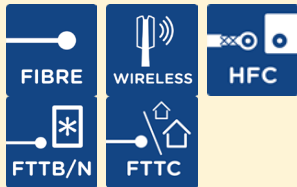

This section applies to **nbn**® Ethernet (Fibre), **nbn**® Ethernet (Wireless), **nbn**® Ethernet (HFC), **nbn**® Ethernet (FTTB), **nbn**® Ethernet (FTTN) and **nbn**® Ethernet (FTTC).

nbn will migrate one or more AVCs or a single CVC using the Same POI Migration Order in respect of **nbn**® Ethernet (Fibre), **nbn**® Ethernet (Wireless), **nbn**® Ethernet (HFC), **nbn**® Ethernet (FTTB), **nbn**® Ethernet (FTTN) and **nbn**® Ethernet (FTTC).

A **Same POI Migration Order** is a Modify Order for the migration (as specified in section 4.5.7 [Same POI Migration Order Activities](#)) of one or more AVCs or one CVCs where the originating POI location and destination POI location are the same.

4.5.7.1 Same POI Migration Order Activities

A Same POI Migration Order may be used to undertake any of the following activities:

Activity	Description of activity
Migrate an AVC	The migration of a single AVC (together with a UNI-D and/or UNI-V) <ul style="list-style-type: none"> • from being associated with one CVC to being associated with another CVC which serves the same CSA.
Bulk migration of AVCs	The migration in bulk of multiple AVCs (together with their respective UNI-Ds and/or UNI-Vs): <ul style="list-style-type: none"> • from being associated with one CVC to being associated with another CVC which serves the same CSA; or • from all having one bandwidth profile, to all having another bandwidth profile.
Migrate a CVC	The migration of a single CVC from either one NNI to another NNI at the same POI.



Important: There will be a brief service interruption (typically lasting less than 1 minute) when the Same POI Migration Order is processed in respect of an AVC migration. This brief service interruption is not an Outage or a Service Fault.

4.5.7.2 Same POI Migration Orders: Interactions

The following table describes the interactions that may occur when placing a Same POI Migration Order in respect of one or more AVCs or a single CVC:

Who	Activity
Your organisation...	<p>Submits a Same POI Migration Order for the AVC or CVC migration using the nbn[®] Service Portal.</p> <p>Note: Where nbn considers it to be appropriate, nbn will work with your organisation to complete bulk migration of AVCs within a migration slot requested by your organisation.</p>
nbn...	<p><i>(If the Same POI Migration Order relates to one or more AVCs)</i> Completes the Same POI Migration Order in respect of the specified AVC(s) by:</p> <ul style="list-style-type: none"> • migrating each AVC, one at a time, to the new designated CVC; or • modifying in respect of each AVC, the bandwidth profile of that AVC. <p><i>(If the Same POI Migration Order relates to a single CVC)</i></p> <p>Completes the Same POI Migration Order in respect of the specified CVC and, after migration of the CVC, replicates each of the following:</p> <ul style="list-style-type: none"> • all existing service identifiers of the CVC • all service attributes of AVCs associated with the CVC. <p>Updates the CVC S-TAG, if required.</p> <p>Planned Maintenance</p> <p>Modification of a CVC through a Same POI Migration Order may require a Planned Outage. If so, nbn will notify your organisation as described in section 5.5.1.3 Planned Outage Notice: Contents.</p>

4.5.7.3 Same POI Migration Order Life Cycle

The following diagram illustrates the life-cycle of a Same POI Migration Order for the migration of a single CVC or one or more AVCs, including the different Order Status states that may apply:

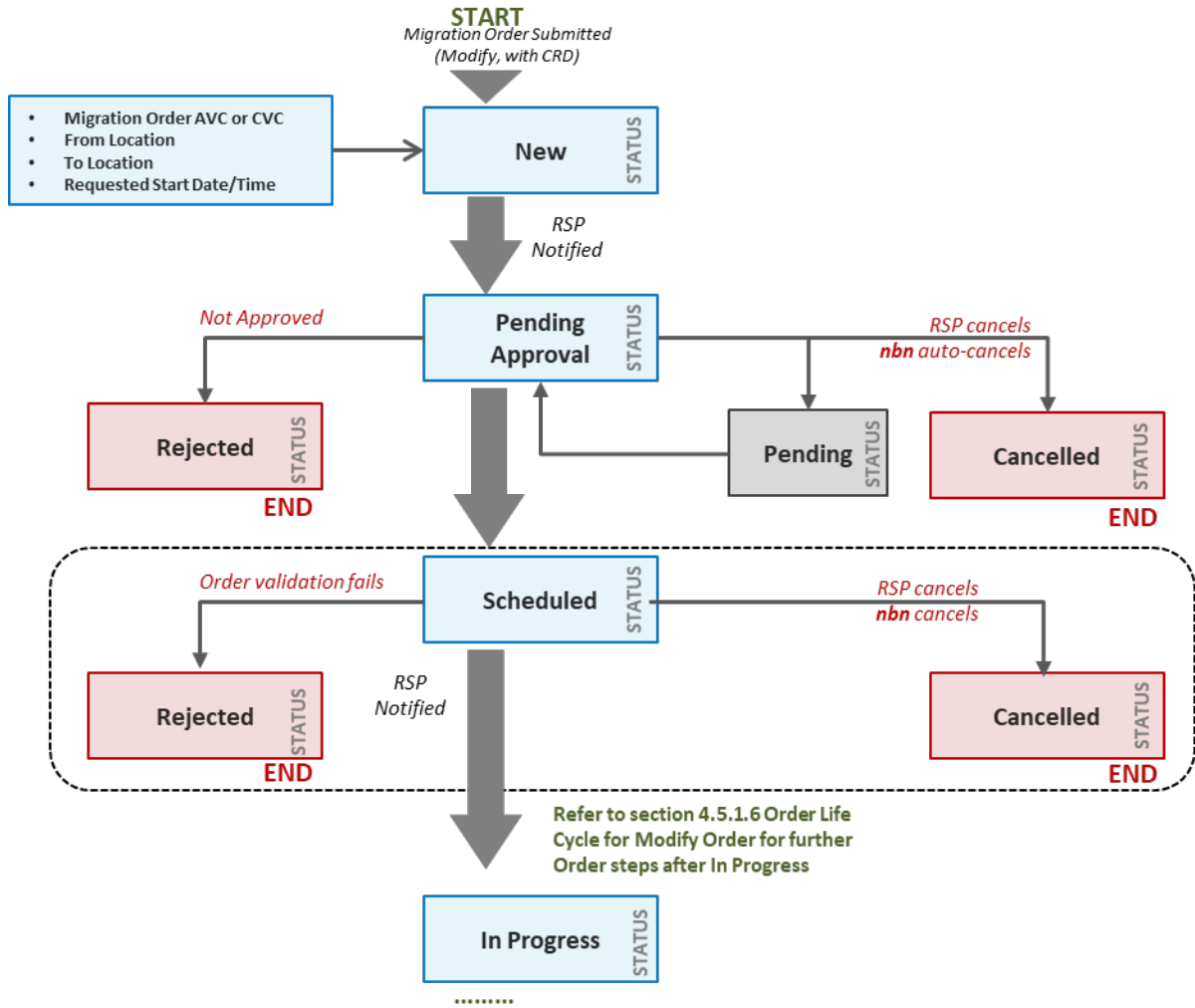

Same POI Migration Orders are subject to the standard Order Status states described in section 4.5.1.6 Order Status Life-cycle except as set out below.

Additional Order Status states of "Pending Approval" and "Scheduled" apply for Same POI Migration Orders.

Order Status Description

The following table defines the Product Components to which "Pending Approval" and "Scheduled" Order Status can apply and the related activities which must be performed by **nbn** or your organisation in each circumstance.

These activities must be performed once the relevant event set out in the table occurs.

Order Status	Affected Product Component types	Relevant event & activities
Pending Approval	<ul style="list-style-type: none"> Connectivity Component Access Component 	<p>Event</p> <p>Your organisation has placed a Same POI Migration Order with nbn with the following attributes:</p> <ul style="list-style-type: none"> One or more AVCs or a CVC for migration Requested Start Date/Time For POI location: <ul style="list-style-type: none"> Originating POI location Destination POI location (must be same as Originating POI location). For Product Component modification: <ul style="list-style-type: none"> Updated bandwidth profile.

Order Status	Affected Product Component types	Relevant event & activities
		<p>Activities</p> <p>nbn has received the Same POI Migration Order and will review the order and if approved will schedule the order.</p> <div style="background-color: #fff9c4; padding: 10px; border: 1px solid #ccc;"> <p> Important: The Requested Start Date/Time in respect of a Same POI Migration Order must be at least 15 Business Days after the date on which your organisation places the Same POI Migration Order.</p> <p>If your organisation requests a start date/time that does not comply with this requirement, nbn will work with your organisation to agree an alternative start date/time, place the Same POI Migration Order in a "Scheduled" Order Status, and will not process it further until that start date/time.</p> </div>
<p>Scheduled</p>	<ul style="list-style-type: none"> • Connectivity Component • Access Component 	<p>Event</p> <p>Your organisation has placed a Same POI Migration Order with nbn and nbn has determined that the order can be scheduled at on the date your organisation requested in the order or another date agreed with your organisation.</p> <p>Activities</p> <p>nbn schedules the Same POI Migration Order and will not process it further until the Requested Start Date/Time.</p>

 **Important:** If your organisation requests an AVC or CVC migration as a Same POI Migration Order and **nbn** determines that the Requested Start Date/Time is not available, or if your organisation does not provide a Requested Start Date/Time, **nbn** will work with your organisation to agree a start date/time, place the Same POI Migration Order in a "Scheduled" Order Status and will not process it further until that start date/time.

4.5.8 NNI Link and V-NNI

4.5.8.1 NNI Link ordering

The steps comprising the process and associated activities **nbn** and your organisation must perform where your organisation orders an NNI Link as agent for and on behalf of V-NNI RSP are defined in the table below:

Who	Activity
Your organisation...	Orders the NNI (if required)
nbn...	Activates the NNI (if required)
Your organisation...	Modifies the NNI by adding an NNI Link and specifies the V-NNI RSP the NNI Link is being created for and behalf of
nbn...	<ul style="list-style-type: none"> • Activates the NNI Link On Activation, the status of the NNI Link order advances to Complete • Notifies your organisation and the relevant V-NNI RSP that NNI Link order is Complete

4.5.8.2 V-NNI ordering

The steps comprising the process and associated activities **nbn** and your organisation must perform where your organisation orders a V-NNI are defined in the table below:

Note: Prior to ordering a V-NNI, an NNI Link RSP must acquire an Upstream NNI Link as agent for and on behalf of your organisation.

Who	Activity
Your organisation...	Orders a V-NNI
nbn...	<ul style="list-style-type: none"> Activates the V-NNI On Activation, the status of the V-NNI order advances to Complete Notifies your organisation and the relevant NNI Link RSP that the V-NNI order is Complete
Your organisation...	Orders a CVC and associates the CVC to the V-NNI
nbn...	Completes the CVC Order
Your organisation...	<i>(When nbn completes the CVC order)</i> Orders AVC/UNI for each Premises
nbn...	Completes the AVC/UNI order

4.5.8.3 Order Types

Your organisation can place the following order types for each of the following Product Feature or Product Component:

Product Feature	Order Type	Order via ...
NNI Link	<ul style="list-style-type: none"> Modify Order 	<ul style="list-style-type: none"> nbn[®] Service Portal B2B Access*

Product Component	Order Type	Order via ...
V-NNI	<ul style="list-style-type: none"> Connect Order Disconnect Order 	<ul style="list-style-type: none"> nbn[®] Service Portal B2B Access*

***Note:** Ordering via B2B access will not be available until your organisation is notified by **nbn**.

Note: Where your organisation has ordered an NNI Link or a V-NNI, any Order Accepted Notification, Completed Notification, Rejected Notification or Cancelled Notification in respect of that order will also be sent to the relevant V-NNI RSP or NNI Link RSP (as applicable).

4.5.8.4 Point of No Return

A modification of an NNI (adding NNI Link) and a V-NNI order both reach the Point of No Return when the order status is Complete.

4.5.8.5 Order Accepted Notifications for NNI Link and V-NNI

Once an order has been Acknowledged by **nbn**, an Order Accepted Notification will be sent to your organisation. The Order Accepted Notification will include the following information about your organisation's order for the following Product Feature or Product Component:

Product Feature ordered	Information supplied in the Order Accepted Notification
NNI Link	<ul style="list-style-type: none"> • Order ID • Bandwidth • S-TAG pool • Relevant V-NNI RSP ID

Product Component ordered	Information supplied in the Order Accepted Notification
V-NNI	<ul style="list-style-type: none"> • Order ID • POI ID • NNI Link ID • Bandwidth • S-TAG pool <p>Note: The V-NNI characteristics are set by the NNI Link ID</p>

4.5.8.6 Additional Ordering information for NNI Link and V-NNI

NNI Link

For each NNI Link ordered, your organisation must designate the following:

- The V-NNI RSP associated with the NNI Link
- Bandwidth Profile (this must be within the parameters of the Linked NNI)
- S-TAG pool allocated (these must be within the parameters of the linked NNI)

V-NNI

For each V-NNI ordered, your organisation must designate the following:

- The NNI Link ID

4.5.8.7 Modify Orders for NNI Link and V-NNI

The following are the allowable modifications to be made to NNI Link:

- Bandwidth
- S-Tag Range

Note: nbn will reject any Modify Orders to reduce the NNI Link Parameters unless there is sufficient spare capacity on the associated Downstream V-NNI to accommodate the Modification.

Note: The modification of an NNI to remove the NNI Link will be rejected if there is a V-NNI attached to the NNI Link

Note: Modify Order for a V-NNI is not available. To modify the parameters of a V-NNI, your organisation must arrange for the relevant Upstream NNI Link RSP to place a modify order for the relevant Upstream NNI Link as your agent and on your behalf.

4.5.8.8 Disconnect Orders for V-NNI

Before a disconnection order of a V-NNI can be raised, nbn must have completed the Disconnect Order for all associated CVCs and AVCs.

4.6 Installing nbn[®] Equipment

An Installation may be required where your organisation places an order for the Access Components of nbn[®] Ethernet in respect of a Premises, including in connection with a Centralised Deployment at a Multi-Premises Site.

4.6.1 Installation and Charges

Charges apply for some Installations. Your organisation will only incur Charges where your organisation or the relevant Appointment Representative has consented to the details of a quote provided by **nbn** in respect of that Installation.



Important: If **nbn** provides a quote in respect of an Installation, **nbn** will only seek consent from your organisation in respect of that quote. **nbn** will not seek the consent of the relevant Appointment Representative.



Important: If **nbn** conducts an Installation for a Centralised Deployment in connection with a Non-Addressable Object which your organisation or a Downstream Service Provider wishes to serve, **nbn** will only seek consent to the details of a quote from your organisation and **nbn** will not seek the consent of the Appointment Representative.

See the [nbn® Ethernet Price List](#) for further details of the Charges which apply to Installations.

4.6.2 Installation Guides

During the On-boarding process, **nbn** will supply your organisation with a copy of the relevant installation guides, which describe the complete installation process for Connecting Equipment and related requirements.

Your organisation must comply with the rules described in these installation guide documents.

4.6.3 Standard Installations and Non Standard Installation

Standard Installation and **Non Standard Installation** have the meaning given to those terms in section 29 of the [nbn® Ethernet Product Terms](#) which is extracted below for ease of reference only. If there is any inconsistency between section 29 of the [nbn® Ethernet Product Terms](#) and the extract below, section 29 of the [nbn® Ethernet Product Terms](#) will prevail to the extent of any inconsistency.

Operational Notes



Important: **nbn** is not responsible for in-building cabling and cannot progress an order unless suitable in-building cabling connecting the Customer Side MDF to the relevant Premises exists.



Important: Where a new Lead-In Cable is required, **nbn** is not responsible for providing suitable trenching and conduit or the erection of poles, including clearing, digging and re-instatement of land between the property entry point and the building entry point. If such works are not completed to **nbn**'s reasonable satisfaction, **nbn** may place the order into Pending.



Important: The following applies in respect of FTTC-NCD Connecting Equipment:

- For a Service Class 31 **nbn**® Copper Pair and Service Class 32 **nbn**® Copper Pair, **nbn** will attend the Premises to install the FTTC-NCD Connecting Equipment as part of a Standard Installation in accordance with section [4.6.7.1 Installation of FTTC-NCD Connecting Equipment at Service Class 31 Copper Pair and Service Class 32 Copper Pair](#).
- For a Service Class 33 **nbn**® Copper Pair or a Service Class 34 **nbn**® Copper Pair in respect of which an NCD Shortfall applies, a Standard Installation will include the installation of the FTTC-NCD Connecting Equipment by means of an End User Installation – FTTC (**nbn** Dispatched). **nbn** will only attend a Premises to install the FTTC-NCD Connecting Equipment as part of an optional **nbn** Professional Installation - FTTC (which is not a Standard Installation).

- A Charge may apply for a **nbn** Professional Installation - FTTC in accordance with the [nbn® Ethernet Price List](#) and, for the avoidance of doubt, no charge will apply for an Accelerated Connection.



Important: The following applies in respect of HFC-NTD Connecting Equipment:

- For a Service Class 21 or 22 Premises, **nbn** will attend a Premises to install the HFC-NTD Connecting Equipment as part of a Standard Installation;
- For a Service Class 23 Premises:
 - **nbn** will attend a Premises to install the HFC-NTD Connecting Equipment as part of a Standard Installation, prior to the date **nbn** introduces an End User Installation – HFC;
 - on and from the date **nbn** introduces an End User Installation – HFC, a Standard Installation will include the installation of the HFC-NTD Connecting Equipment by means of an End User Installation – HFC (**nbn** Dispatched). During this period, **nbn** will only attend a Premises to install the HFC-NTD Connecting Equipment as part of:
 - an optional Accelerated Connection; or
 - an optional **nbn** Professional Installation – HFC (which is not part of a Standard Installation); or
 - a mandatory **nbn** Professional Installation – HFC in accordance with sections [4.6.6.3 Multiple RF Device Premises](#), [4.6.6.5 RSP Professional Installation – HFC](#), [4.6.6.6 \(End User Installation – HFC \(RSP Dispatched\)\)](#) or [4.6.6.7 End User Installation – HFC \(nbn Dispatched\)](#).
 - A Charge may apply for an **nbn** Professional Installation – HFC in accordance with the [nbn® Ethernet Price List](#) and for the avoidance of doubt no charge will apply for an Accelerated Connection.
- **nbn** will undertake such End User and RSP trials to test its processes regarding these installation methods as it determines are necessary prior to introducing:
 - End User Installation HFC; or
 - Any installation method for HFC-NTD Connecting Equipment at a Service Class 23 Premises that involves your organisation installing the HFC-NTD Connecting Equipment.



Important: Where a new HFC Lead-In Cable is required, **nbn** is not responsible for providing suitable trenching and conduit or the erection of poles, including clearing, digging and re-instatement of land between the property entry point and the building entry point (HFC Trenching Works). If such HFC Trenching Works are not completed to **nbn**'s reasonable satisfaction, **nbn** may place the order into Pending.



What happens when an Installation takes longer than the designated Appointment?

nbn will place the order in Pending. Your organisation must schedule a follow-up Appointment with the Contracted End User, and reserve an Appointment date and time via the **nbn**® Service Portal.

For **nbn**® Ethernet (FTTB), **nbn**® Ethernet (FTTN) and **nbn**® Ethernet (FTTC), if **nbn** cannot complete the work on the day of the Appointment, **nbn** will endeavour, where relevant, to roll back the installation of Jumper Cable where possible to leave the End User service as it was previously identified.

For **nbn**® Ethernet (HFC), if **nbn** cannot complete the work on the day of the Appointment, **nbn** will endeavour, where relevant, and possible to leave the End User service as it was previously identified.

Section 29 of the **nbn**® Ethernet Product Terms

29. Standard Installations and Non Standard Installations

29.1 Standard Installations

Subject to sections 29.2 and 29.4, an Installation in respect of a Premises will be a **Standard Installation** if each of the following conditions is satisfied:

- (a) all Connecting Equipment in respect of that Premises:
 - (i) can be installed during a single Appointment (where the [WBA Operations Manual](#) specifies that an Appointment is required); and
 - (ii) can be installed and activated during Standard Hours;
- (b) **nbn** (or the Installer):
 - (i) has been provided with necessary rights of access to the Premises and any other property as required under this Agreement; and
 - (ii) is given access to the MDF, Common Property and the Premises, as required by **nbn**, during the Appointment (where the [WBA Operations Manual](#) specifies that an Appointment is required), to complete the installation of the Connecting Equipment (including any necessary inspection or related works);
- (c) with respect to a Premises to which **nbn** will supply **nbn**[®] Ethernet (Fibre):
 - (i) no more than one Drop Fibre, one PCD, one Connecting Fibre and one NTD and, one fibre wall outlet needs to be installed;
 - (ii) if a Drop Fibre needs to be installed, it:
 - (A) is only required from the NAP to the PCD;
 - (B) can be installed at the Premises:
 - (1) through an existing lead-in conduit;
 - (2) through a new lead-in conduit; or
 - (3) aurally; and
 - (C) needs to be no more than 60 metres in length, measured by the cable run distance between:
 - (1) the property boundary point that is nearest to the location of both the PCD and NAP; and
 - (2) the location of that PCD;
 - (iii) if a PCD needs to be installed, it can be installed on the exterior of the Building at which the Premises is located;
 - (iv) the Connecting Fibre needs to be no more than 40 metres in length, measured by the cable run distance between the PCD and the location of the NTD;
 - (v) the NTD and an associated Power Supply Unit can be attached to the interior side of a wall of the Premises, at a location agreed between the End User and **nbn** (or the Installer) which has a 240 volt power source which is:
 - (A) within a distance that will allow a direct connection to the indoor component of the NTD; and
 - (B) available to supply electricity to the NTD and an associated Power Supply Unit; and
 - (vi) the NTD requires:
 - (A) a cable which is no more than 1.8 metres from the 240 volt power source to the Power Supply Unit; and
 - (B) a cable which is no more than 3 metres from the Power Supply Unit to the NTD;
- (d) with respect to a Premises to which **nbn** will supply **nbn**[®] Ethernet (FTTB), no more than one Jumper Cable needs to be installed between the **nbn**[®] Side MDF and the Customer Side MDF;
- (e) with respect to a Premises to which **nbn** will supply **nbn**[®] Ethernet (FTTN), which is at an MDU Site, no more than one Jumper Cable needs to be installed between the **nbn**[®] Side MDF and the Customer Side MDF;
- (f) with respect to a Premises to which **nbn** will supply **nbn**[®] Ethernet (FTTN) which is not at an MDU

Site:

- (i) no more than one Lead-In Cable, one PCD, one Copper Connecting Cable, and one Telecommunications Outlet or Passive NTD need to be installed;
 - (ii) if a Lead-In Cable needs to be installed, it:
 - (A) is only required from the network connection point to the PCD which serves the Premises;
 - (B) can be installed at the Premises:
 - (1) through an existing lead-in conduit;
 - (2) through a new lead-in conduit; or
 - (3) aurally; and
 - (C) needs to be no more than 60 metres in length, measured by the cable run distance between:
 - (1) the property boundary point that is nearest to the location of the network connection point; and
 - (2) the location of the PCD or building entry point;
 - (iii) if a PCD needs to be installed, it can be installed on the exterior of the Building at which the Premises is located; and
 - (iv) the Copper Connecting Cable needs to be no more than 40 metres in length measured by the cable run distance between the PCD or building entry point, and the location of the **nbn**[®] Network Boundary;
- (g) with respect to a Premises to which **nbn** will supply **nbn**[®] Ethernet (FTTC), which is at an MDU Site, subject to section 29.1(i):
- (i) no more than one Jumper Cable between the **nbn**[®] Side MDF and the Customer Side MDF and one set of FTTC-NCD Connecting Equipment needs to be installed; and
 - (ii) a functional Telecommunications Outlet is in place and is at a location which has a 240 volt power source which is:
 - (A) within a distance from the Telecommunications Outlet that will allow direct connection to the FTTC-NCD; and
 - (B) available to supply electricity to the FTTC-NCD;
- (h) with respect to a Premises to which **nbn** will supply **nbn**[®] Ethernet (FTTC) which is not at an MDU Site, subject to section 29.1(i):
- (iii) no more than one Lead-In Cable, one PCD, one Copper Connecting Cable, one Telecommunications Outlet or Passive NTD and one set of FTTC-NCD Connecting Equipment needs to be installed;
 - (iv) if a Lead-In Cable needs to be installed, it:
 - (A) is only required from the **nbn**[®] DPU to the PCD which serves the Premises;
 - (B) can be installed at the Premises:
 - (1) through an existing lead-in conduit;
 - (2) through a new lead-in conduit; or
 - (3) aurally; and
 - (C) needs to be no more than 60 metres in length, measured by the cable run distance between:
 - (1) the property boundary point that is nearest to the location of the **nbn**[®] DPU used to serve that Premises; and

- (2) the location of the PCD or building entry point;
- (v) if a PCD needs to be installed, it can be installed on the exterior of the Building at which the Premises is located;
- (vi) a Telecommunications Outlet or Passive NTD is in place, or a new Telecommunications Outlet can be attached to the interior side of a wall of the Premises, at a location agreed between the End User and **nbn** (or the Installer) which has a 240 volt power source which is:
 - (A) within a distance of the Telecommunications Outlet or Passive NTD that will allow direct connection to the FTTC-NCD; and
 - (B) available to supply electricity to the FTTC-NCD; and
- (vii) the Copper Connecting Cable needs to be no more than 40 metres in length measured by the cable run distance between the PCD or building entry point, and the location of the **nbn**[®] Downstream Network Boundary;
- (i) for a Service Class 33 Premises or Service Class 34 Premises in respect of which an FTTC-NCD Shortfall applies, the FTTC-NCD Connecting Equipment is installed by End User Installation – FTTC only;
- (j) with respect to a Premises to which **nbn** will supply **nbn**[®] Ethernet (Wireless):
 - (i) no more than one NTD indoor component, one NTD outdoor component and one connecting cable between the indoor and outdoor units of the NTD need to be installed;
 - (ii) if an NTD outdoor component needs to be installed, it can be installed in a location where the cable run distance between the indoor and outdoor units of the NTD is no more than 30 metres in length; and
 - (iii) the NTD indoor component and an associated Power Supply Unit can be attached to the interior side of a wall of the Premises, at a location agreed between the End User and **nbn** (or the Installer) which has a 240 volt power source which is:
 - (A) within a distance that will allow a direct connection to the indoor component of the NTD; and
 - (B) available to supply electricity to the NTD and an associated Power Supply Unit;
- (k) with respect to a Premises to which **nbn** will supply **nbn**[®] Ethernet (Satellite):
 - (i) no more than one NTD indoor component, one NTD outdoor component, one mount and up to two connecting cables (as required) between the indoor and outdoor units of the NTD and, where applicable, one additional Power Supply Unit (Standard) and one power converter need to be installed;
 - (ii) if an NTD outdoor component needs to be installed, it can be installed in a location where the cable run distance between the indoor and outdoor units of the NTD is no more than 50 metres in length; and
 - (iii) the NTD indoor component and any associated Power Supply Unit can be attached to the interior side of a wall of the Premises, at a location agreed between the End User and **nbn** (or the Installer) which:
 - (A) if the AC Power Supply Unit is installed, has a 240 volt power source which is:
 - (1) within a distance that will allow a direct connection to the indoor component of the NTD; and
 - (2) available to supply electricity to the NTD and any associated Power Supply Unit; or
 - (B) if the DC Power Supply Unit is installed, has a power source which:
 - (1) complies with any requirements notified by **nbn** from time to time;
 - (2) is within a distance that will allow a direct connection to the indoor component of the NTD; and

- (3) is available to supply electricity to the NTD and any associated Power Supply Unit;
- (l) with respect to a Premises to which **nbn** will supply **nbn**® Ethernet (HFC), subject to section 29.1(m):
 - (i) no more than one set of each of the HFC Wall Outlet Connecting Equipment and the HFC-NTD Connecting Equipment need to be installed;
 - (ii) if a Lead-In Cable needs to be installed, it:
 - (A) is only required from the HFC Tap to the PCD which serves the Premises;
 - (B) can be installed at the Premises:
 - (1) through an existing lead-in conduit;
 - (2) through a new lead-in conduit; or
 - (3) aerially; and
 - (C) needs to be no more than 60 metres in length, measured by the cable run distance between:
 - (1) the property boundary point that is nearest to the location of the network connection point; and
 - (2) the location of the PCD or building entry point;
 - (iii) if a PCD needs to be installed, it can be installed on the exterior of the Building at which the Premises is located;
 - (iv) the HFC Connecting Cable needs to be no more than 40 metres in length measured by the cable run distance between the PCD or building entry point, and the location of the first HFC Wall Outlet; and
 - (v) a functioning HFC Wall Outlet is in place or a new HFC Wall Outlet can be attached to the interior side of a wall of the Premises, at a location agreed between the End User and **nbn** (or the Installer) which has a 240 volt power source which is:
 - (A) within a distance of the HFC Wall Outlet that will allow direct connection to the HFC-NTD;
 - (B) available to supply electricity to the HFC-NTD and its associated Power Supply (Standard); and
 - (C) available to supply electricity to the HFC Premises Amplifier Power Supply (if installed); and
- (m) for a Service Class 23 Premises, the HFC-NTD Connecting Equipment is installed by End User Installation – HFC (**nbn** Dispatched) only.

29.2 Non Standard Installations

Notwithstanding anything in section 29.1 but subject to section 29.4, an Installation in respect of a Premises will be a Non Standard Installation if **nbn** (or the Installer) determines, acting reasonably, that the Installation is not a "standard installation" having regard to all of the following:

- (a) generally accepted industry practices and any applicable industry guidelines, policies, laws, regulations or directions;
- (b) the level of complexity and difficulty associated with the Installation;
- (c) the uniqueness of the circumstances associated with the Installation;
- (d) the presence of obstacles, dangers or other safety concerns during the time of Installation;
- (e) in a Multi-Premises Site, where the requirements of a Centralised Deployment location introduces complexity, uniqueness, obstacles, dangers or other safety concerns;
- (f) in a Multi-Premises Site, where the Installation is unable to occur during Standard Hours or a third party (e.g. a building manager or owner) imposes other procedural or other constraints;
- (g) for **nbn**® Ethernet (Fibre), whether the Connecting Fibre is more than 40 metres in length measured by the cable run distance between the PCD and the location of the NTD;
- (h) for **nbn**® Ethernet (FTTN) and **nbn**® Ethernet (FTTC), whether the Copper Connecting Cable is more

than 40 metres in length measured by the cable run distance between the PCD or building entry point, and the location of the **nbn**[®] Network Boundary;

- (i) for **nbn**[®] Ethernet (FTTC), whether the Lead-In Cable is more than 60 metres in length measured by the cable run distance between the property boundary point that is nearest to the location of the **nbn**[®] DPU used to serve that Premises and the location of the PCD or building entry point;
- (j) for **nbn**[®] Ethernet (HFC), whether the HFC Connecting Cable is more than 40 metres in length measured by the cable run distance between the PCD or building entry point, and the location of the **nbn**[®] Network Boundary;
- (k) for **nbn**[®] Ethernet (Wireless), whether the cable run distance between the indoor and outdoor units of the NTD is more than 30 metres in length; and
- (l) for **nbn**[®] Ethernet (Satellite), whether:
 - (i) the Installation will occur in a Limited Access Area;
 - (ii) the Installation requires special mounting or HSE arrangements; and
 - (iii) the cable run distance between the indoor and outdoor units of the NTD is more than 50 metres in length.

29.3 Exclusions from Standard Installations

- (a) In addition to any limitations in sections 29.1 and 29.2 regarding what Installations will be Standard Installations, the following activities will not form part of any Standard Installation even if **nbn** agrees to perform such activities at the same time as a Standard Installation:
 - (i) a Professional Wiring Service;
 - (ii) installing or reconfiguring in-building wiring (including In-building Wiring) from the **nbn**[®] Downstream Network Boundary to the Telecommunications Outlet (where applicable);
 - (iii) extending or altering a serviceable pre-existing Lead-In Cable or Copper Connecting Cable within a Premises (regardless of the length of the Lead-In Cable or Copper Connecting Cable);
 - (iv) for **nbn**[®] Ethernet (FTTB), **nbn**[®] Ethernet (FTTN) and **nbn**[®] Ethernet (FTTC), the provision of any infrastructure beyond the **nbn**[®] Downstream Network Boundary (except any **nbn**[®] Equipment);
 - (vi) for **nbn**[®] Ethernet (FTTB), any trenching in order to provide services to an individual Premises;
 - (vi) for **nbn**[®] Ethernet (FTTN) and **nbn**[®] Ethernet (FTTC), where a new Lead-In Cable is required, any trenching and conduit or the erection of poles, including clearing, digging and re-instatement of land between the property entry point and the building entry point; and
 - (vii) for **nbn**[®] Ethernet (HFC), where a new HFC Lead-In Cable is required, any trenching and conduit or the erection of poles, including clearing, digging and re-instatement of land between the property entry point and the building entry point (**HFC Trenching Works**).
- (b) Without limiting **nbn**'s obligations under this Agreement, pursuant to clause E4 of the [Head Terms](#), **nbn** will not be responsible for any of the activities described in sections 29.3(a)(i) to 29.3(a)(iv).
- (c) **nbn** will not be responsible for any of the activities described in sections 29.3(a)(v) to 29.3(a)(vii), except that until the Expiry Date, **nbn** will undertake HFC Trenching Works as part of an Initial Standard Installation or an Initial Non-Standard Installation (as the case may be).

29.4 FTTN/C Fibre Upgrade Installations

Notwithstanding anything in sections 29.1 and 29.2, an FTTN/C Fibre Upgrade Installation will not be a Standard Installation or Non Standard Installation.

4.6.4 Activities: Installation

The steps comprising the process for Installing **nbn**[®] Equipment and Central Splitter (where required), and the associated activities **nbn** and your organisation must perform in relation to each step, are defined in the table below:



Important: If **nbn** conducts an Installation for a Centralised Deployment in connection with a Non-Addressable Object which your organisation or a Downstream Service Provider wishes to serve, your organisation waives all requirements in the following table for **nbn** to communicate with the Appointment Representative, provide them with documentation or obtain their consent to specific activities or charges.



In the table below, activities related to *Rearrangement / Modification* are only applicable to **nbn**[®] Ethernet (Fibre), **nbn**[®] Ethernet (Wireless), **nbn**[®] Ethernet (Satellite) and **nbn**[®] Ethernet (HFC).

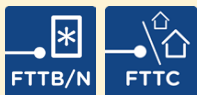







In the table below, activities related to *Professional Wiring Service* are only applicable to **nbn**[®] Ethernet (FTTB), **nbn**[®] Ethernet (FTTN) and **nbn**[®] Ethernet (FTTC).

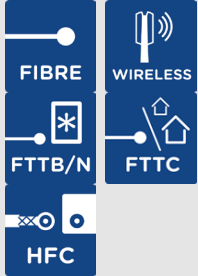



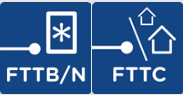
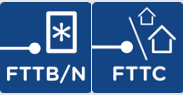

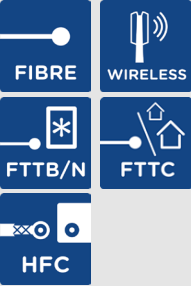
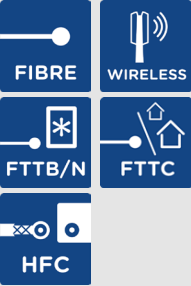

Important: **nbn** may notify your organisation if **nbn** considers that any in-premises wiring is adversely affecting the performance of any **nbn**[®] Ethernet Ordered Product, RSP Product or Downstream Product.

If **nbn** provides your organisation with a notification under the paragraph above, at the next End User Contact Event, your organisation must use reasonable endeavours to inform the Contracted End User that **nbn** considers that the in-premises wiring may be adversely affecting the performance, or End User experience, of an **nbn**[®] Ethernet Ordered Product, RSP Product or Downstream Product (as applicable), together with any additional details provided by **nbn** regarding the effect of the in-premises wiring.

Who	Activity
<p>Your organisation...</p> 	<p>Must inform Contracted End Users of all of the following information:</p> <ul style="list-style-type: none"> • The date and time of the Appointment • When and if Late Cancellation (Site Visit Required) Charges apply • When and if Missed Appointment Charges apply • Any other information pertinent to the Installation (including any applicable Charges).
<p>Your organisation...</p> 	<p>Must inform Contracted End Users of all of the following information:</p> <ul style="list-style-type: none"> • When and if Late Cancellation (Site Visit Required) Charges apply • When and if Missed Appointment Charges apply • The expected timeframe for completion of the Installation, based on the Service Levels or Operational Targets (as applicable) for the Premises • That nbn will, within two Business Days of your organisation submitting an order with a valid Appointment ID, contact them to schedule an Actual Appointment • Any other information pertinent to the Installation (including any applicable Charges).
<p>nbn ...</p>	<p>Identifies the type of Installation required at the Premises as being one of:</p> <ul style="list-style-type: none"> • An Initial Standard Installation • An Initial Standard Installation (1 Port NTD) • An Initial Standard Installation (4 Port NTD)



Who	Activity
	<ul style="list-style-type: none"> • An Initial Non Standard Installation • An Initial Non Standard Installation (1 Port NTD) • An Initial Non Standard Installation (4 Port NTD) • A Subsequent Installation (with or without a Professional Wiring Service) • FTTN/C Fibre Upgrade Installation (1 Port NTD) • FTTN/C Fibre Upgrade Installation (4 Port NTD) • A Professional Wiring Service (whether or not at the time of a Standard Installation or Non-Standard Installation) • A Rearrangement / Modification. <p>Note: In respect of a Premises for which nbn will supply nbn® Ethernet (Fibre), if nbn determines, acting reasonably, that the Installation at the Premises requires a Customer Installed Fibre Cable Pathway, nbn will inform your organisation. See further 4.5.2.2 Product Component Orders: Additional Information.</p>
<p>nbn ...</p> 	<p>May at the time of an Installation assess the suitability of an End User Premises for In-Premises Wiring Activities and where it deems appropriate, nbn may conduct In-Premises Wiring Activities at the same time as the Installation.</p>
<p>Your organisation...</p> 	<p>Must ensure that Downstream Service Providers obtain, or procure that the End User consents for nbn Personnel to carry out In-Premises Wiring Activities at the time of an Installation.</p>
<p>Your organisation...</p>	<p>Where an Appointment requires attendance of the Appointment Representative, must make sure that one of the same is present at the Premises during the entirety of each Appointment.</p> <div style="background-color: #fff9c4; padding: 10px; border: 1px solid #ccc;"> <p> Important: Not all types of Installation for nbn® Ethernet require the Appointment Representative to be at the Premises during the Appointment (see section 6.2 Appointment Overview)</p> </div> <p>What happens if the above does not occur?</p> <p>nbn is not required to complete the Installation.</p>
<p>Your organisation...</p> 	<p>Must indicate, at the time of ordering nbn® Ethernet (Satellite), confirmation that nbn or its personnel have the necessary rights to de-install and remove (as applicable) any existing satellite equipment. (nbn may de-install existing satellite equipment at the Premises if nbn determines, in its sole discretion, that de-installation of existing satellite equipment is necessary to proceed with your order for nbn® Ethernet (Satellite), (for example, if there is a health, safety and environment issue or if the Satellite NTD needs to be installed in the same location as existing satellite equipment). Note that nbn will only de-install satellite equipment supplied under the Interim Satellite Service, Australian Broadband Guarantee or nbn Satellite Support Scheme and only if the dish component of the equipment is less than or equal to 1.2 metres in diameter)</p> <p>What happens if the above does not occur?</p> <p>nbn is not required to do either of the following:</p> <ul style="list-style-type: none"> • De-install (and remove, if applicable) any existing satellite equipment • Connect and activate the Premises' Access Components. <div style="background-color: #fff9c4; padding: 10px; border: 1px solid #ccc;"> <p> Important: De-installation of any existing satellite equipment will halt the supply of any existing satellite service over the equipment. Your organisation is responsible for informing Contracted End Users of all service and billing impacts of any de-installation of satellite equipment in connection with your order for nbn® Ethernet (Satellite).</p> </div>
<p>nbn ...</p>	<p><i>(For Initial Non Standard Installations, Initial Non Standard Installations (1 Port NTD), Initial Non Standard Installations (4 Port NTD), Subsequent Installations and Rearrangement / Modification)</i></p>

Who	Activity
	<p>Informs the Contracted End User that the Installation is (as applicable) an Initial Non Standard Installation, an Initial Non Standard Installation (1 Port NTD), an Initial Non Standard Installation (4 Port NTD), a Subsequent Installation, or a Rearrangement / Modification.</p>
<p>nbn ...</p> 	<p><i>(For the following:</i></p> <ul style="list-style-type: none"> c. Initial Non Standard Installations, d. Subsequent Installations (other than a Subsequent Installation that only comprises a Standard Installation (whether or not at the same time of a Professional Wiring Service) related to nbn[®] Ethernet (FTTB), nbn[®] Ethernet (FTTN) or nbn[®] Ethernet (FTTC) Ordered Products for which Charges apply as specified in the nbn[®] Ethernet Price List), e. Subsequent Installations (other than a Subsequent Installation that only comprises a Standard Installation related to nbn[®] Ethernet (FTTC) Ordered Products for which Charges apply as specified in the nbn[®] Ethernet Price List), and f. Rearrangement / Modification). <p><i>Then nbn:</i></p> <ul style="list-style-type: none"> • Determines the Charges for the Installation. • Supplies the Appointment Representative with a quotation for the Charges and advises them that your organisation may bill them for such Charges. • Advises the Appointment Representative that their consent is required in relation to the details of the quotation, before the Installation can proceed.
<p>nbn ...</p> 	<p><i>(For Rearrangement / Modification)</i></p> <p>Advises the Appointment Representative consent is required in relation to the details of the quotation, before the Installation can proceed.</p> <p>What happens if the Appointment Representative does not consent to the details of the quote?</p> <p>nbn is not required to connect and activate the Premises' Access Components.</p>
<p>nbn ...</p> 	<p><i>(For Installations for which a Charge applies)</i></p> <ul style="list-style-type: none"> • Determines the Charges for the Installation • Provides your organisation with a quote for the Charges.
<p>Your organisation...</p> 	<p><i>(For Installations for which a Charge applies)</i></p> <ul style="list-style-type: none"> • Informs the Appointment Representative of the details of the quote provided by nbn and obtains their consent to the details of that quote • Advises the Appointment Representative that their consent is required in relation to the details of the quotation, before the Installation can proceed • Informs nbn as to whether both your organisation and the Appointment Representative consent to the details of the quote.
<p>nbn ...</p> 	<p>In respect to Installations related to nbn[®] Ethernet (Fibre) Ordered Products, provides the Appointment Representative with a nbn[®] <i>Operations User Guide</i>.</p>
<p>nbn ...</p> 	<p>Advises the Appointment Representative that their consent is required as to the location of the outdoor unit of the Satellite NTD before the Installation can proceed.</p>

Who	Activity
nbn ...	<p><i>(If the Installer identifies a Service Fault that prevents the Installer from completing the Installation process.)</i></p> <p>The Installer will remain at the Premises or other location and resolve the Service Fault.</p> <p>Exceptions - this does not apply in any of the following situations:</p> <ul style="list-style-type: none"> • The Installation requires additional equipment, which nbn or the Installer is not in possession of at that point in time • nbn determines that the Service Fault cannot be resolved within the allotted Appointment or other Installation timeframe • It would be dangerous to the health or safety of any person or property for nbn to continue installing and testing the Connecting Equipment • nbn installs a Temporary Cable in respect of a Premises • Access not available to required areas or services • Any other circumstance arises that would prevent a competent contractor from being able to complete activities required to complete the Installation.
	<p><i>(If the Installer is unable to complete a quality of Installation (QoI) activity due to a weather event)</i></p> <p>The Installer will leave the Premises and the QoI activity will be re-run remotely by nbn after the weather event has cleared. If nbn is unable to complete the QoI activity, nbn will contact the Appointment Representative to arrange an Appointment to return to the Premises.</p>
nbn ...	<p><i>(At the completion of the Installation.)</i></p> <p>Where an Appointment requires attendance of the Appointment Representative, ensures that the person in attendance signs the work order for the Installation.</p> <div style="background-color: #fff9c4; padding: 10px; border: 1px solid #ccc;"> <p> Important: Not all types of Installation for nbn[®] Ethernet require the Appointment Representative to be at the Premises during the Appointment (see section 6.2 Appointment Overview).</p> </div>

4.6.5 Subsequent Installations of NTDs

 For Public Interest Premises served by the Satellite Network, your organisation may request a Subsequent Installation of an NTD by contacting the **nbn**[®] Relationship Point of Contact. **nbn** may accept or reject the request at its discretion.

   This section applies for **nbn**[®] Ethernet (Fibre), **nbn**[®] Ethernet (Wireless) or **nbn**[®] Ethernet (HFC).

Your organisation may order a Subsequent Installation of an NTD (including an NTD Add or NTD Replace) where:

- There is no capacity for a UNI-D port on an existing NTD at the relevant Premises
- The order is for supply of an AVC TC-4 Product Component that will (once supplied) result in the total aggregate upstream PIR or downstream PIR for all AVC TC-4 ordered products supplied to that NTD exceeding the available bandwidth of that NTD as determined by nbn
- The order is in connection with a Non-Addressable Object to be served from a particular Centralised Deployment location and the existing NTD(s) at that Centralised Deployment location are already dedicated to Non-Addressable Object(s) other than the one to which the order applies.

nbn will accept an order for a Subsequent Installation of an NTD for a Premises other than a Multi-Premises Site if all of the following conditions are met:

- For **nbn**[®] Ethernet (Fibre), **nbn**[®] Ethernet (Wireless) and **nbn**[®] Ethernet (HFC), where there is only one existing NTD at the relevant Premises
- There are no UNI-D ports available on the existing NTD or the order is for an AVC TC-4 Product Component that will (once supplied) result in the total aggregate upstream PIR or downstream PIR for all AVC TC-4 ordered products supplied to that NTD exceeding the available bandwidth of that NTD as determined by **nbn**
- For a Modify Order, the Subsequent Installation is not an NTD Add
- For an NTD Replace, there is no Battery Backup Service or UNI-V supplied to your organisation or any Other RSP in respect of the NTD being replaced
- **nbn** determines that the Fibre Network or HFC Network (as applicable) can support the requested additional connectivity to the Premises without **nbn** installing additional network resources.

nbn will accept an order for a Subsequent Installation of an NTD for a Multi-Premises Site if there are no NTDs installed in a Centralised Deployment location associated with a Non-Addressable Object or each NTD in the Centralised Deployment location is being used in association with another Non-Addressable Object, and one of the following conditions is met:



- **nbn** determines it is practical to install a subsequent NTD in the Centralised Deployment location
- **nbn** determines that it is practical to install a subsequent NTD in an alternative Centralised Deployment location which your organisation may use to supply an RSP Product (or support the supply of a Downstream Product) to the Non-Addressable Object,



and all of the following conditions are met:

- **nbn** determines that the Fibre Network or HFC Network (as applicable) can support the requested additional connectivity to the Premises without **nbn** installing additional network resources
- **nbn** determines that the relevant Centralised Deployment location can support the subsequent NTD (including considering environmental factors and requirements of owners, occupiers and managers of the Multi-Premises Site) without **nbn** having to modify the Centralised Deployment location or incur incremental costs to access the Centralised Deployment location.
- For an NTD Replace, there is no Battery Backup Service or UNI-V supplied to your organisation or any Other RSP in respect of the NTD being replaced.

nbn may (in its discretion) accept an order for a Subsequent Installation of an NTD if the conditions above are not met.

If **nbn** accepts an order for a Subsequent Installation of an NTD, it will process that order subject to the following:

	<p>The Service Class for the relevant Premises or Non-Addressable Object will be changed to:</p> <ul style="list-style-type: none"> • Service Class 2 where a physical connection is in place between the NAP and the PCD (including where the Drop Fibre and PCD are installed as part of the Fibre Network) and no augmentation or patching between the PCD and the NAP is required for the supply of the relevant Ordered Product; or • Service Class 1 where a physical connection is not in place between the NAP and the PCD or augmentation or patching between the PCD and the NAP is required for the supply of the relevant Ordered Product. <p>Note: These updates may not necessarily be reflected in the nbn[®] Platform Interfacing Service.</p>
	<p>The Service Class for the relevant Premises will be changed to Service Class 5 for nbn[®] Ethernet (Wireless).</p>

	<p>The Service Class for the relevant Premises or Non-Addressable Object will be changed to:</p> <ul style="list-style-type: none"> • Service Class 22 (as applicable to the relevant Premises or Non-Addressable Object) for nbn[®] Ethernet (HFC); or • Service Class 23 (as applicable to the relevant Premises or Non-Addressable Object), if <ul style="list-style-type: none"> • an RSP Professional Installation – HFC; • an End User Installation – HFC (nbn Dispatched); or • an End User Installation – HFC (RSP Dispatched) <p>is accepted in accordance with section 4.6.6 nbn[®] Ethernet (HFC) Installation Options.</p>
 	<p>Site Qualification for this Premises subject to the above Service Class changes may not reflect this change in the Service Class.</p>

The order for the Subsequent Installation will proceed as a Connect Order in accordance with:

- Section [4.5.2.1 Interactions: Connect Order](#); or
- if, an RSP Professional Installation – HFC, an End User Installation – HFC (**nbn** Dispatched), or an End User Installation – HFC (RSP Dispatched) is accepted, the relevant subsection in section [4.6.6 nbn[®] Ethernet \(HFC\) Installation Options](#).

4.6.6 nbn[®] Ethernet (HFC) Installation Options

	<p>This section applies to Connect Orders and Modify Orders for nbn[®] Ethernet (HFC) for Service Class 23 and Service Class 24 Premises (additional HFC-NTD installation or missing HFC-NTD only) - see section 4.3.1.4 NTD Shortfall.</p>
---	---

4.6.6.1 HFC Installation Workforce options

Important: Your organisation must have successfully completed relevant On-boarding before submitting a Connect Order or Modify Order in respect of installation options using Self-Install Kit – HFC.

When submitting a Connect Order for **nbn**[®] Ethernet (HFC) in respect of a Service Class 23 or Service Class 24 Premises (additional HFC-NTD Installation or replacement of missing HFC-NTD only) or a Modify Order that involves an NTD Replace, your organisation must select one of the following Installation workforce options:

Connect Order installation option	Installation workforce	Self-Install Kit - HFC
<ul style="list-style-type: none"> • nbn Professional Installation – HFC • RSP Professional Installation – HFC 	<ul style="list-style-type: none"> • “nbn[®] Install” • “RSP Install” 	<p style="text-align: center;">x</p> <p style="text-align: center;">✓</p>
<p>End User Installation - HFC</p> <ul style="list-style-type: none"> • End User Installation – HFC (nbn Dispatched) • End User Installation – HFC (RSP Dispatched) 	<ul style="list-style-type: none"> • “nbn[®] Install End User” • “RSP Install End User” 	<p style="text-align: center;">✓</p> <p style="text-align: center;">✓</p>



Important: In respect of installations using the End User Installation – HFC (RSP Dispatched) or RSP Professional Installation – HFC installation options, your organisation must comply with, and must procure that your Downstream Service Providers comply with, the **Supply Terms for the Self-Install Kit – HFC & FTTC**.

4.6.6.2 Eligibility criteria for using Self-Install Kit – HFC



Important: nbn is not able to determine the complexity of the Premises for:

- an End User Installation – HFC (**nbn** Dispatched), or
- an End User Installation – HFC (RSP Dispatched).

Prior to submitting a Connect Order or a Modify Order in respect of:

- an End User Installation – HFC (**nbn** Dispatched); or
- an End User Installation – HFC (RSP Dispatched),

your organisation must use (and must procure each Downstream Service Provider, uses) reasonable endeavours to determine that the selected installation option is appropriate for the Premises.

These steps include, but are not limited to, ensuring that:

- A Self-Installation Consent - HFC has been obtained for installation options where the Contracted End User installs the Connecting Equipment;
- Determining that the Contracted End User can identify and locate the HFC Wall Outlet, see **HFC Checklist – Self Install Kit**;
- The Premises does not require Rearrangement / Modification, see section [4.7.1 Interactions: Rearrangement, Removal or Repair](#);
- The order is not an Accelerated Connection order; and
- The Premises is not a Multiple RF Device Premises in respect of which a **nbn** Professional Installation - HFC must be ordered, see [4.6.6.3 Multiple RF Device Premises](#).



Important: Your organisation must request an **nbn** Professional Installation - HFC where the Connect Order is for an Accelerated Connection.

4.6.6.3 Multiple RF Device Premises

Your organisation must request an **nbn** Professional Installation - HFC or a Subsequent Installation of an HFC-NTD for **Multiple RF Device Premises** in accordance with the following table:

Number of RF Signal Terminating Devices at Premises	Service Class	HFC-NTD status	Subsequent Installation of an NTD	nbn Professional Installation - HFC
≥ 3	24	Missing	✘	✓
≥ 3	24	No UNI ports available	✓	✘
≥ 3	23	N/A	✘	✓



Important: Your organisation may submit a Connect Order for a Subsequent Installation of an NTD (see section 4.6.5 Subsequent Installations of NTDs) by requesting one of the following installation options an RSP Professional Installation – HFC; an End User Installation – HFC (RSP Dispatched); or an End User Installation – HFC (**nbn** Dispatched), if:

- there are no UNI ports available on the existing HFC-NTD;
- the Premises is not a Multiple RF Device Premises; and
- there is an available Wall Outlet at the Premises.

4.6.6.4 Submitting Connect Orders and Modify Orders for Self-Install Kit - HFC

The following table describes the interactions that may occur when submitting a Connect Order in respect of a Service Class 23 Premises or Service Class 24 Premises (missing HFC-NTD or no UNI port available) or a Modify Order that involves an NTD Replace.

Who	Activity
<p>Your organisation...</p>	<p>May submit a Connect Order or Modify Order requesting one of the installation of the HFC-NTD Connecting Equipment using installation options set out in section 4.6.6.1 HFC Installation Workforce options in accordance with the terms of this section 4.6.6 nbn[®] Ethernet (HFC) Installation Options.</p> <p>Must provide the Contracted End User with your organisation’s contact details from which assistance can be obtained if the Contracted End User has questions or issues with the installation process.</p> <p>A Connect Order or Modify Order with an installation option using the Self-Install Kit - HFC may be cancelled or the installation option amended at any time prior the Point of No Return in accordance with section 4.5.1.4 Point of No Return.</p> <p><i>(If nbn advises that the Self-Install Kit - HFC could not be delivered)</i> May submit an Amendment Order requesting an nbn Professional Installation - HFC or cancel the order in accordance with section 4.5.1.3 Cancelling Orders.</p> <p>For details on Orders where the Installation workforce is:</p> <ul style="list-style-type: none"> • “RSP Install” see section 4.6.6.5 RSP Professional Installation – HFC, or • “RSP Install End User” see section 4.6.6.6 End User Installation – HFC (RSP Dispatched), or • “nbn[®] Install End User” see section 4.6.6.7 End User Installation – HFC (nbn Dispatched), or • “nbn[®] Install” see section 4.6.6.8 nbn Professional Installation – HFC.
<p>nbn...</p>	<p>In respect of:</p> <ul style="list-style-type: none"> • RSP Professional Installation – HFC, or • End User Installation – HFC (nbn Dispatched), or • End User Installation – HFC (RSP Dispatched) <p>will update the Status of the order to Rejected if an Installation Appointment has been associated with the order.</p>

4.6.6.5 RSP Professional Installation – HFC

The following diagram and table describes the high level interactions between **nbn** and your organisation that may arise from submitting a Connect Order or Modify Order selecting RSP Professional Installation – HFC (with the Installation workforce option “**RSP Install**”).

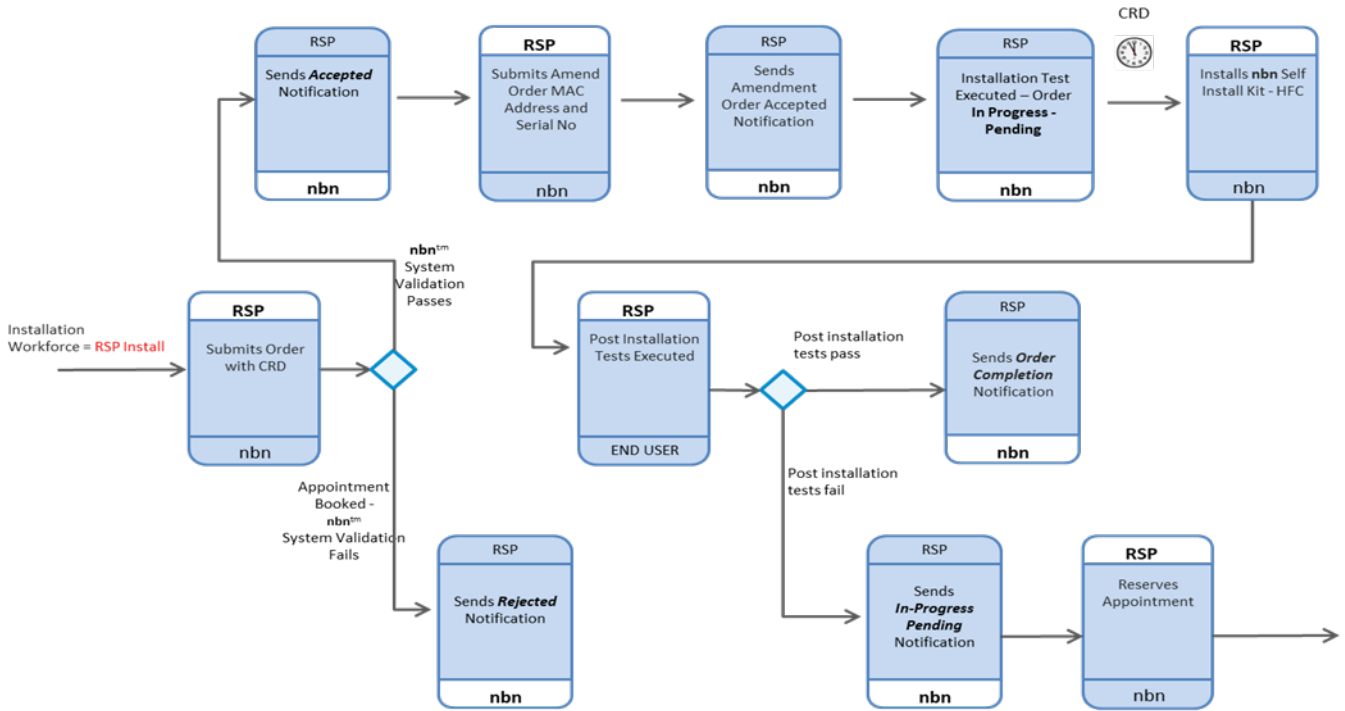

Who	Activity
Your organisation...	<ul style="list-style-type: none"> Must provide a Customer Required Date in respect of the order, see section 6.7.2 Order Lead Times for required lead time. Must ensure that prior to submitting a Connect Order or Modify Order that it has sufficient stock of the Self-Install Kit - HFC on hand to successfully activate the service. May update the order with the HFC-NTD MAC Address and HFC-NTD Serial Number if it is available at the time of submitting the order. Must ensure that the Customer Required Date is requested on the day your organisation is scheduled to attend the Premises.
nbn...	Sends Order Accepted Notification and updates the Order Status to In Progress - Pending .
Your organisation...	<p>(If not provided) Updates the order by submitting the HFC-NTD MAC Address and HFC-NTD Serial Number by means of either an Amendment Order or by such other means provided by nbn to your organisation from time to time to perform this task.</p> <p>Note: nbn intends to provide an application to allow your organisation to update the order by adding the HFC-NTD MAC Address and HFC NTD Serial Number while in attendance at the Premises. nbn will notify your organisation when the application is available.</p>
nbn...	<ul style="list-style-type: none"> (If required) Sends an Amendment Order Accepted Notification. Performs the installation test and the order remains in In Progress - Pending if the HFC-NTD is not detected on the nbn® Network.
Your organisation...	<ul style="list-style-type: none"> Installs the Self-Install Kit - HFC in accordance with the On-boarding processes and practices and after the HFC-NTD is detected on the nbn® Network, post installation tests are executed. (If the automated HFC-NTD post installation tests complete successfully) Obtains confirmation from the Appointment Representative that the service has been successfully activated. (If the automated HFC-NTD post installation tests do not complete successfully or the HFC-NTD otherwise fails to operate after being correctly installed) May perform troubleshooting activities in accordance with the nbn® HFC User Guide, including replacing the HFC-NTD.
nbn...	<ul style="list-style-type: none"> (If the automated HFC-NTD post installation tests complete successfully) Sends a passed post installation test notification, updates the Order Status to Complete and sends an Order Completed Notification.

	<ul style="list-style-type: none"> (If the automated HFC-NTD post installation tests do not complete successfully) Sends a failed post installation test notification. The Order Status is In Progress – Pending.
Your Organisation...	(If the HFC-NTD is not activated successfully, the Order Status remains In Progress – Pending) Must update the order installation workforce to request an nbn Professional Installation - HFC and reserve an Installation Appointment.
Your Organisation...	(If the HFC-NTD has not been activated by the end of the Customer Required Date) See section 4.6.6.9 Failure to Activate by end of Customer Required Date.

4.6.6.6 End User Installation – HFC (RSP Dispatched)

The following diagram and table describes the high level interactions between **nbn** and your organisation that may occur when submitting a Connect Order or Modify Order selecting the End User Installation – HFC (RSP Dispatched) (with the Installation workforce option “RSP Install - End User”).

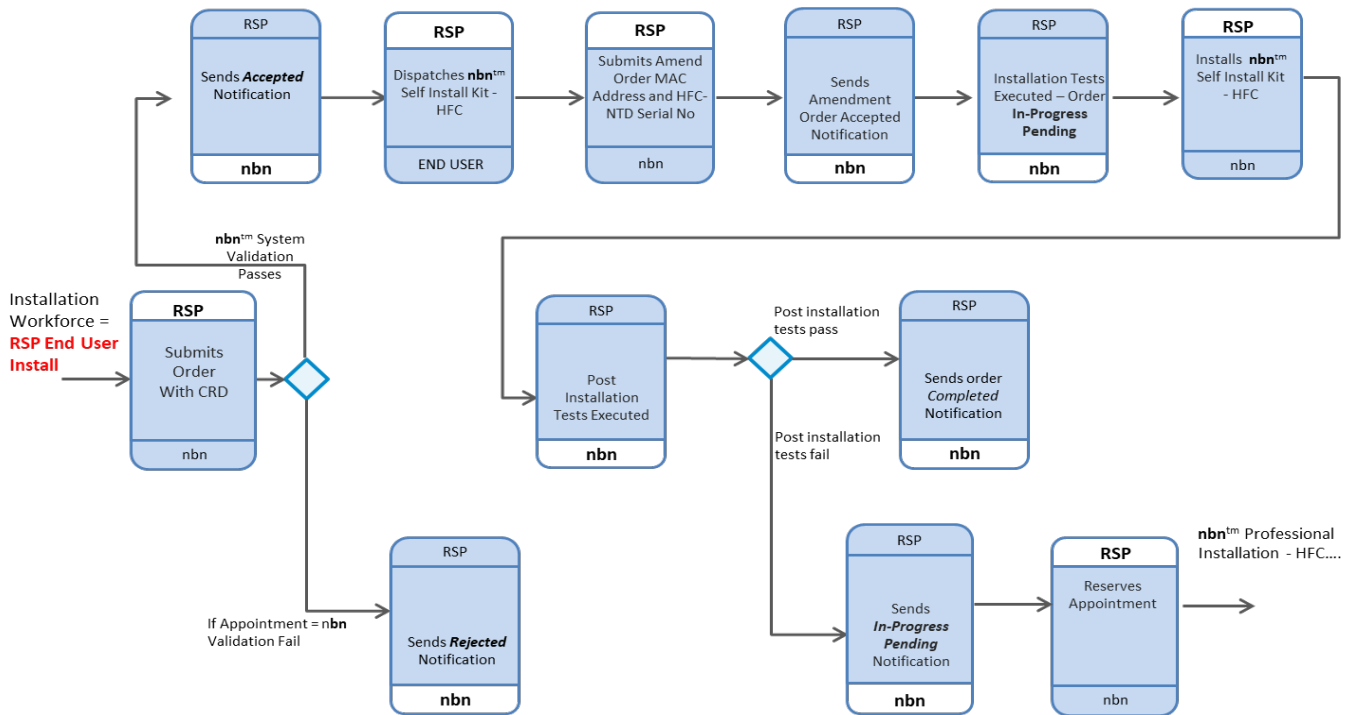

Who	Activity
Your organisation...	<ul style="list-style-type: none"> Must provide a Customer Required Date in respect of the order, see section 6.7.2 Order Lead Times for required lead time for required lead time. Must ensure that prior to submitting a Connect Order or Modify Order that it has sufficient stock of Self-Install Kit – HFC on hand to successfully activate the service. Must ensure that the Self-Install Kit – HFC is dispatched to the Contracted End User to allow for it to be installed on the Customer Required Date. May update the order with the HFC-NTD MAC Address and HFC-NTD Serial Number if it is available at the time of submitting the order.
nbn...	Upon submission of the Order, sends Order Accepted Notification and updates the Order Status to In Progress – Pending .
Your organisation...	Updates the HFC-NTD MAC Address and HFC-NTD Serial Number by means of either an Amendment Order or by such other means provided by nbn to your organisation from time to time to perform this task.

Who	Activity
nbn...	<ul style="list-style-type: none"> • Sends an Amendment Order Accepted Notification. • Performs the installation test and the Order remains in In Progress - Pending if the HFC-NTD is not detected on the nbn[®] Network.
Your organisation...	<ul style="list-style-type: none"> • Must ensure that the Contracted End User promptly installs the nbn[®] Self Install Kit - HFC on or before the Customer Required Date in accordance with the accompanying installation instructions. • If necessary, provides remote assistance to Contracted End User with respect to troubleshooting the installation of the nbn[®] Self Install Kit - HFC.
nbn...	<ul style="list-style-type: none"> • <i>(When the HFC-NTD is detected on the nbn[®] Network)</i> Will launch automated post installation tests. • <i>(If the automated post installation tests complete successfully)</i> Will send a passed post installation tests notification and update the order Status to Complete and send an Order Complete Notification. • <i>(If the post installation tests are not completed successfully or the HFC-NTD otherwise fails to operate after being correctly installed)</i> Sends your organisation a failed post installation tests notification requiring action by your organisation. The Order Status is In Progress – Pending.
Your organisation...	<p><i>(If the Self-Install Kit – HFC;</i></p> <ul style="list-style-type: none"> • <i>is not received by the Contracted End User by the Customer Required Date; or</i> • <i>fails to operate after being installed)</i> <p>May</p> <ul style="list-style-type: none"> • dispatch a new Self-Install Kit – HFC to the Contracted End User and submit an Amendment Order updating the HFC-NTD MAC Address, HFC-NTD Serial Number and Customer Required Date; or • submit an Amendment Order updating the order installation workforce to nbn Professional Installation - HFC and reserve an Installation Appointment. <p>See section 4.6.6.10 Recovery of faulty or unused Self-Install Kit.</p>
nbn...	<p><i>(If the HFC-NTD has not activated at the end of the Customer Required Date)</i> See section 4.6.6.9 Failure to Activate by end of Customer Required Date.</p>

4.6.6.7 End User Installation – HFC (**nbn** Dispatched)

The following diagram and table describes the high level interactions between **nbn** and your organisation that may arise from submitting a Connect Order or Modify Order selecting End User Installation – HFC (**nbn** Dispatched).

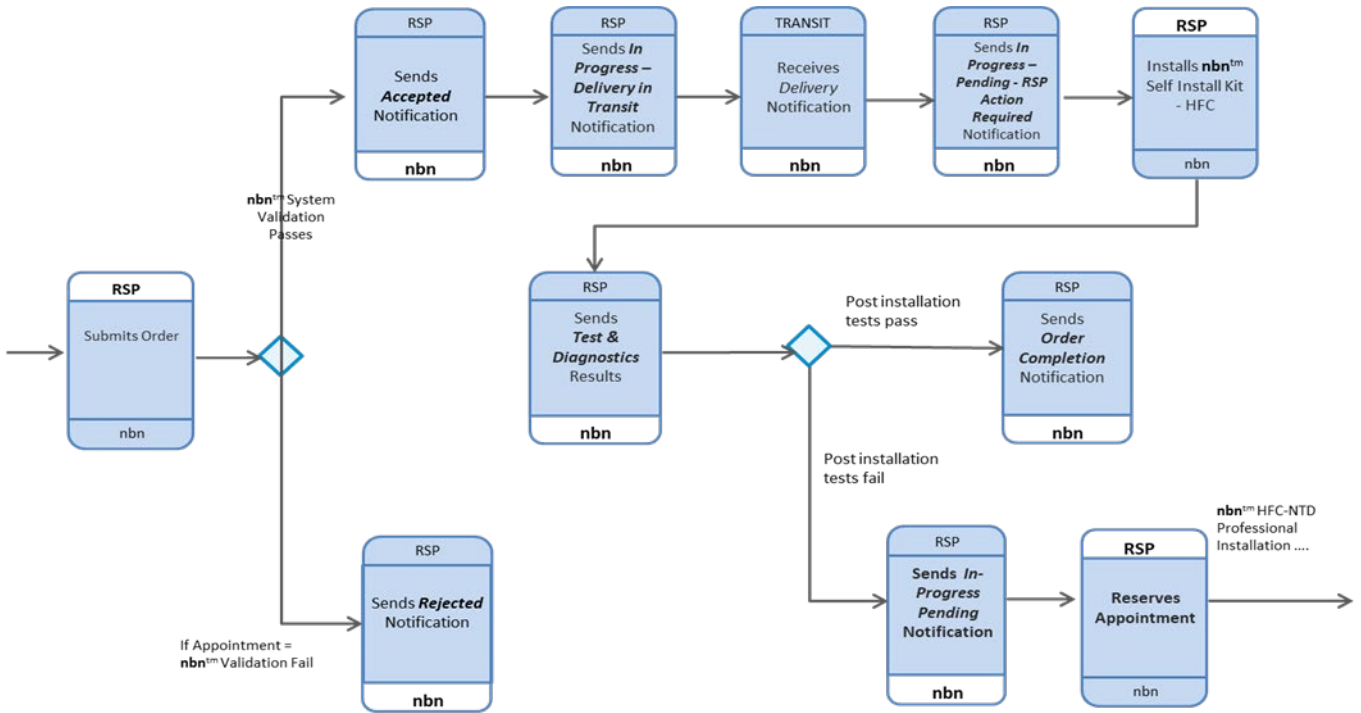

Who	Activity
Your organisation...	<ul style="list-style-type: none"> Must provide the Contracted End User name and mobile telephone number, and may submit the Contracted End User’s email address (optional). (If the Contracted End User has provided an Authority to Leave the Self-Install Kit – HFC) May update the Authority to Leave field on the order. (If the delivery address for the Self-Install Kit – HFC is not the same as the Premises) Must provide a delivery address validated by your organisation to which the Self-Install Kit – HFC will be dispatched.
nbn...	<ul style="list-style-type: none"> Sends Order Accepted Notification and updates the Order Status to In Progress. Dispatches the Self-Install Kit – HFC to the Contracted End User’s delivery address and updates the Order Status to In Progress – delivery in transit. (When nbn dispatches the Self-Install Kit – HFC) Updates the order with the in transit date and time and sends a delivery in transit notification containing the Order ID and shipping tracking identifier. Upon delivery of the Self-Install Kit - HFC to the Contracted End User’s delivery address (or their authorised representative aged 18 or over), updates the Order Status to In Progress – Pending.
Your organisation...	<ul style="list-style-type: none"> Must ensure that the Contracted End User promptly installs the nbn® Self Install Kit - HFC in accordance with the accompanying installation instructions. If necessary, provides remote assistance to Contracted End User with respect to troubleshooting the installation of the nbn® Self Install Kit - HFC.
nbn...	<ul style="list-style-type: none"> (When the HFC-NTD is detected on the nbn® Network), Will launch automated post installation tests. (If the automated post installation tests complete successfully) Sends your organisation a passed post installation tests notification, and updates the Order Status to Complete. (If the post installation tests are not completed successfully or the HFC-NTD otherwise fails to operate after being correctly installed) Sends your organisation a failed post installation tests notification requiring action by your organisation. The Order Status remains In Progress – Pending.

Who	Activity
Your organisation...	<ul style="list-style-type: none"> • <i>(Following receipt of a failed post installation tests notification)</i> May retrigger the post installation tests with the Contracted End User. • <i>(If the HFC-NTD is not activated)</i> May amend the order Installation workforce to request an nbn Professional Installation - HFC and reserve an Installation Appointment.
nbn...	The nbn [®] installation technician will collect the faulty or unused Self-Install Kit – HFC from the Premises.

4.6.6.8 **nbn** Professional Installation – HFC

This section covers the interactions in relation to an initial **nbn** Professional Installation – HFC Order and/or an Amendment Order where the installation option is updated to request an **nbn** Professional Installation - HFC.

Refer to section [4.5.2.1 Interactions: Connect Order](#) for details of order interactions and [4.6.3 Standard Installations](#) for additional information regarding **nbn** Professional Installation - HFC.

Who	Activity
nbn...	<ul style="list-style-type: none"> • Will attend the Premises to install and activate the HFC-NTD Connecting Equipment. • Will remove any unused or faulty Self-Install Kit - HFC previously dispatched to the Premises.

4.6.6.9 Failure to Activate by end of Customer Required Date or Pending period

Who	Activity
nbn...	<ul style="list-style-type: none"> • <i>(Where the installation option is End User Installation – HFC (RSP Dispatched) or RSP Professional Installation – HFC)</i> If the Customer Required Date passes and the HFC-NTD has not been activated on the nbn HFC Network, the Order Status remains In Progress-Pending. • <i>(For all installation options)</i>, 28 Business Days after the Order has been placed into In Progress – Pending Will send a reminder notification to your organisation. • <i>(For all installation options)</i> Will send a cancellation notification and update the Order Status to Cancelled if your organisation does not take a requested action within 30 Business Days of receiving the Pending notification.
Your organisation...	<i>(If more time is required before the Order is cancelled)</i> , May send a request for more time in accordance with section 4.5.1.6 Order Status Life-cycle .

4.6.6.10 Recovery of faulty or unused Self-Install Kit - HFC

See the **Supply Terms for the Self-Install Kit - HFC & FTTC**, for details relating to returning faulty or unused Self-Install Kit - HFC to **nbn**.

This section describes the activities required to recover Self-Install Kit - HFC from a Contracted End User's Premises.

Final Installation Option*	Recovery of unused or faulty Self-Install Kit - HFC
End User Installation – HFC (RSP Dispatched)	Refer to the <i>Supply Terms for the Self-Install Kit - HFC & FTTC</i> , for details of the returns process.
RSP Professional Installation – HFC	Your organisation’s installation technician must collect the faulty or unused Self-Install Kit – HFC from the Premises. Refer to the <i>Supply Terms for the Self-Install Kit - HFC & FTTC</i> , for details of the returns process.
End User Installation – HFC (nbn Dispatched)	Your organisation must ensure the Contracted End User posts the unused or faulty Self-Install Kit - HFC to nbn using the return address label in the Self-Install Kit – HFC.
nbn Professional Installation - HFC	The nbn ® installation technician will collect the faulty or unused Self-Install Kit – HFC supplied via any installation option when attending the Premises.

* Note: The first three options apply unless, at the end of an unsuccessful activation, your organisation requests an **nbn** Professional Installation – HFC.

4.6.7 **nbn**® Ethernet (FTTC) - Installation Options



This section applies to Connect Orders for **nbn**® Ethernet (FTTC) for:

- Service Class 31 **nbn**® Copper Pairs;
- Service Class 32 **nbn**® Copper Pairs;
- Service Class 33 **nbn**® Copper Pairs; and
- Service Class 34 **nbn**® Copper Pairs.

4.6.7.1 Installation of FTTC-NCD Connecting Equipment at Service Class 31 Copper Pair and Service Class 32 Copper Pair

The following diagram and table describes the high level interactions between **nbn** and your organisation that may arise from submitting a Connect Order for a Service Class 31 and a Service Class 32 Copper Pair.

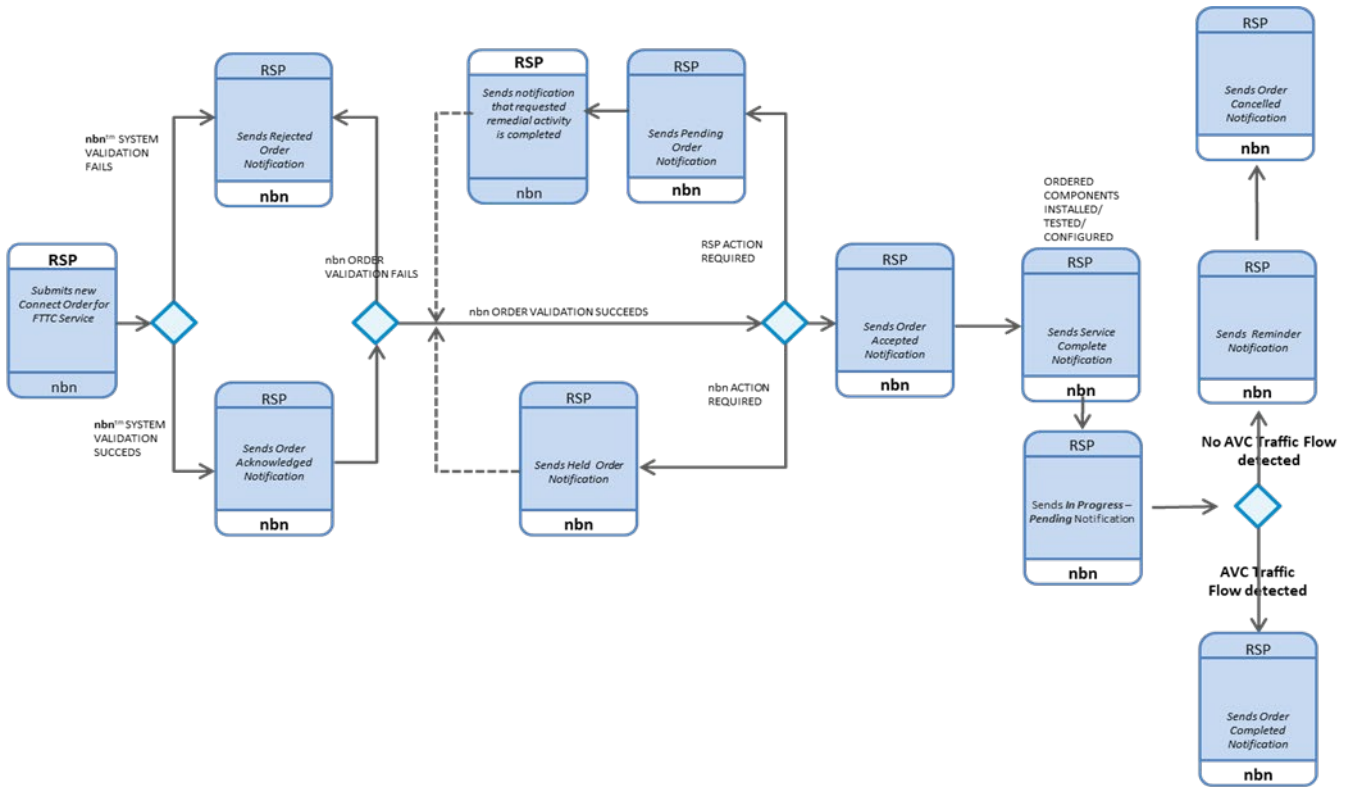

Refer to section 4.5.2.1 Interactions: Connect Order for details of order interactions up until the Order Accepted Notification is sent

Who	Activity
nbn...	(For a Service Class 31 nbn ® Copper Pair and Service Class 32 nbn ® Copper Pair on which there is no active legacy retail service supplied) Will attend the Premises to install and activate the Connecting Equipment and update the Order Status to " In Progress - Pending ".
nbn...	(For a Service Class 32 nbn ® Copper Pair on which there is an active legacy retail service supplied): <ul style="list-style-type: none"> • Will attend the Premises to: <ul style="list-style-type: none"> • install and activate the FTTC-NCD Connecting Equipment (which forms part of the Self-Install Kit - FTTC); • disconnect the FTTC-NCD Connecting Equipment; • use reasonable endeavours to reconnect the active legacy retail service supplied over the nbn® Copper Pair; and • leave at Premises the Self-Install Kit - FTTC and update the Order Status to "In Progress - Pending".
Your organisation...	(For a Service Class 32 nbn ® Copper Pair on which there is an active legacy retail service supplied and Order Status is ' In Progress - Pending ') <ul style="list-style-type: none"> • Must ensure that the Contracted End User promptly installs the Self Install Kit - FTTC in accordance with the accompanying installation instructions. • If necessary, provide remote assistance to Contracted End User with respect to troubleshooting the installation of the Self Install Kit - FTTC.

4.6.7.2 FTTC Installation Workforce Options for a Service Class 33 nbn® Copper Pair and Service Class 34 nbn® Copper Pair



Important: Your organisation must have successfully completed relevant On-boarding before submitting a Connect Order in respect of installation options using Self-Install Kit – FTTC.

When submitting a Connect Order for nbn® Ethernet (FTTC) in respect of a Service Class 33 or Service Class 34 nbn® Copper Pair in respect of which an FTTC-NCD Shortfall applies, your organisation must select one of the following Installation workforce options:

Connect Order installation option	Installation workforce	Self-Install Kit - FTTC
<ul style="list-style-type: none"> nbn Professional Installation – FTTC RSP Professional Installation – FTTC 	<ul style="list-style-type: none"> "nbn® Install" "RSP Install" 	<ul style="list-style-type: none"> ✘ ✓
End User Installation - FTTC <ul style="list-style-type: none"> End User Installation – FTTC (nbn Dispatched) End User Installation – FTTC (RSP Dispatched) 	<ul style="list-style-type: none"> "nbn® Install End User" "RSP Install End User" 	<ul style="list-style-type: none"> ✓ ✓



Important: In respect of installations using the End User Installation – FTTC (RSP Dispatched) or RSP Professional Installation – FTTC installation options, your organisation must comply with, and must procure that your Downstream Service Providers comply with, the **Supply Terms for the Self-Install Kit – HFC & FTTC**.

Eligibility Criteria for using Self-Install Kit – FTTC



Important: nbn is not able to determine the complexity of the Premises for:

- an End User Installation – FTTC (nbn Dispatched), or
- an End User Installation – FTTC (RSP Dispatched).

Prior to submitting a Connect Order in respect of:

- an End User Installation – FTTC (nbn Dispatched), or
- an End User Installation – FTTC (RSP Dispatched),

your organisation must use (and must procure each Downstream Service Provider, uses) reasonable endeavours to determine that the selected installation option is appropriate for the Premises.

These steps include, but are not limited to, ensuring that:

- a Self-Installation Consent - FTTC has been obtained for installation options where the End User installs the Self-Install Kit - FTTC;
- the Contracted End User can identify and locate at least one Telecommunications Outlet;
- the Premises does not require Rearrangement / Modification, see section [4.7.1 Interactions: Rearrangement, Removal or Repair](#); and
- the order is not an Accelerated Connection order.

Submitting Connect Orders for Self-Install Kit – FTTC

The following table describes the interactions that may occur when submitting a Connect Order in respect of a Service Class 33 nbn® Copper Pair or Service Class 34 nbn® Copper Pair in respect of which an FTTC-NCD Shortfall applies.

Who	Activity
Your organisation...	<p>May submit a Connect Order requesting one of the installation of the FTTC-NCD Connecting Equipment using one of the installation options set out in section 4.6.7.2 FTTC Installation Workforce Options in accordance with the terms of this section 4.6.7 nbn® Ethernet (FTTC) - Installation Options.</p> <p>A Connect Order with an installation option using the Self-Install Kit - FTTC may be cancelled or the installation option amended at any time prior to the Point of No Return in accordance with section 4.5.1.4 Point of No Return.</p> <p><i>(If the installation of the Self-Install Kit – FTTC fails)</i> May amend the order Installation workforce to request an nbn Professional Installation - FTTC and reserve an Installation Appointment</p> <p>For details on Connect Orders where the Installation workforce is:</p> <ul style="list-style-type: none"> • “RSP Install” see section RSP Professional Installation – FTTC, or • “RSP Install End User” see section End User Installation – FTTC (RSP Dispatched) • “nbn® Install End User” see section End User Installation – FTTC (nbn Dispatched).
nbn...	<p><i>In respect of:</i></p> <ul style="list-style-type: none"> • RSP Professional Installation – FTTC, or • an End User Installation – FTTC (nbn Dispatched), or • an End User Installation – FTTC (RSP Dispatched), <p>will update the Status of the Connect Order to Rejected if an Installation Appointment has been associated with the Connect Order.</p>



Important: Subject to section 11 of the [nbn® Ethernet Product Terms](#), your organisation may submit a Connect Order for a Subsequent Installation of an FTTC-NCD at a Service Class 34 **nbn**® Premises by requesting one of the following installation options an RSP Professional Installation – FTTC; an End User Installation – FTTC (RSP Dispatched); or an End User Installation – FTTC (**nbn** Dispatched), if:

- there are no UNI ports available on the existing FTTC-NCD at the Premises; and
- there is an available Telecommunications Outlet in respect of the relevant **nbn**® Copper Pair.

nbn Professional Installation – FTTC

This section covers the interactions in relation to an initial **nbn** Professional Installation Connect Order and/or an Amendment Order where the installation option is updated to request an **nbn** Professional Installation - FTTC.

Refer to section [4.5.2.1 Interactions: Connect Order](#) for details of order interactions and section [4.6.3 Standard Installations](#) for additional information regarding **nbn** Professional Installation - FTTC.

Who	Activity
Your organisation...	<p>Must ensure that all necessary End User Equipment is at the Premises prior to the Appointment for nbn Professional Installation – FTTC.</p> <p>This is to ensure that the End User can install the End User Equipment immediately, otherwise the End User will be left without a working service.</p>
nbn...	<ul style="list-style-type: none"> • Will attend the Premises to install and activate the FTTC-NCD Connecting Equipment. • Will remove any unused or faulty Self-Install Kit - FTTC previously dispatched to the Premises.

RSP Professional Installation – FTTC

The following diagram and table describes the high level interactions between **nbn** and your organisation that may arise from submitting a Connect Order selecting RSP Professional Installation – FTTC (with the Installation workforce option “**RSP Install**”).

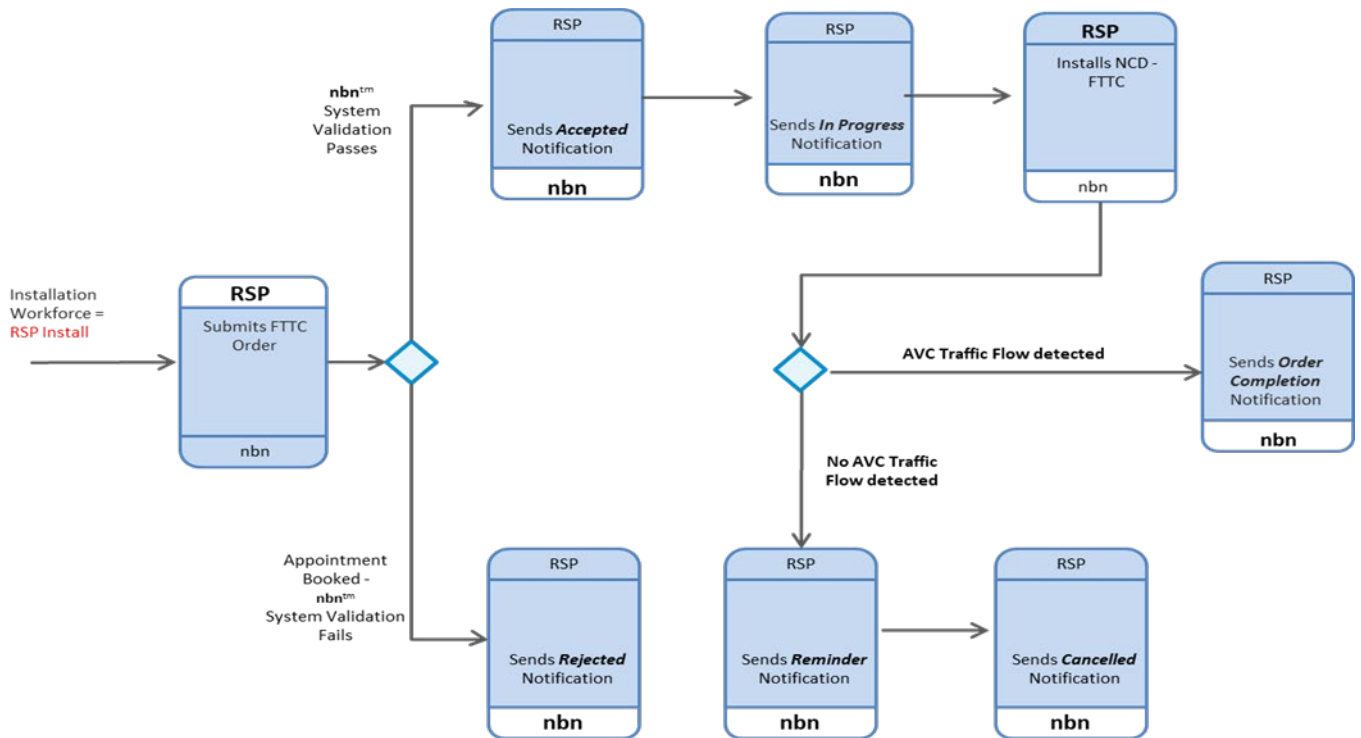

Who	Activity
Your organisation...	Must ensure that prior to submitting a Connect Order that it has sufficient stock of the Self-Install Kit - FTTC on hand to successfully activate the service.
nbn...	Sends Order Accepted Notification and updates the Order Status to " In Progress – Pending ", awaiting successful installation and confirmation of AVC Traffic Flow.
Your organisation...	Must install the FTTC-NCD as soon as possible after Order Acceptance Notification in accordance with the On-boarding processes and practices.

End User Installation – FTTC (RSP Dispatched)

The following diagram and table describes the high level interactions between **nbn** and your organisation that may occur when submitting a Connect Order selecting the End User Installation – FTTC (RSP Dispatched) (with the Installation workforce option “RSP Install - End User”).

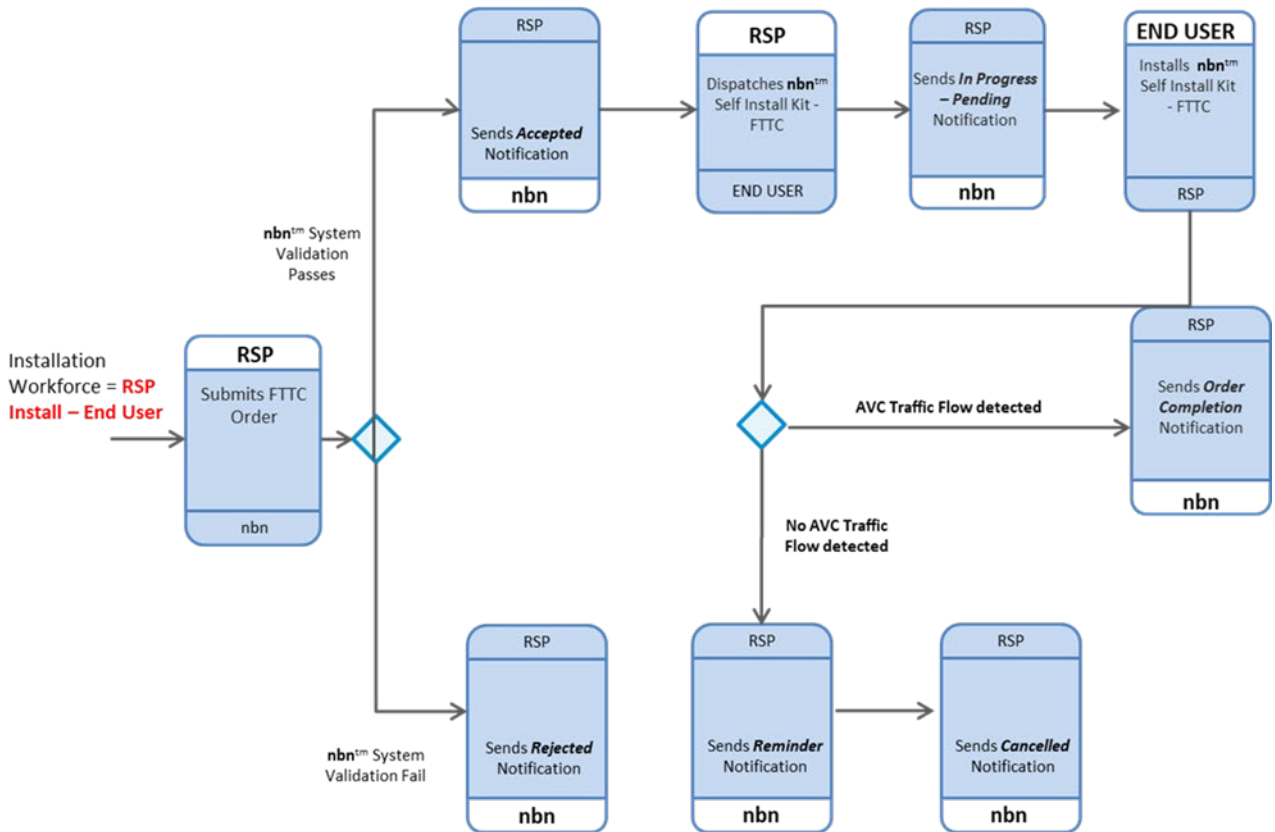

Who	Activity
Your organisation...	Must ensure that prior to submitting a Connect Order that it has sufficient stock of Self-Install Kit – FTTC on hand to successfully activate the service.
nbn...	Sends Order Accepted Notification and updates the Order Status to " In Progress - Pending ", awaiting successful installation and confirmation of AVC Traffic Flow.
Your organisation...	<ul style="list-style-type: none"> • Must ensure that the Self-Install Kit – FTTC is dispatched to the Contracted End User. • Must ensure that the Contracted End User promptly installs the Self Install Kit - FTTC as soon as possible from the Order Accepted Notification. • If necessary, provides remote assistance to Contracted End User with respect to troubleshooting the installation of the Self Install Kit - FTTC.

End User Installation – FTTC (nbn Dispatched)

The following diagram and table describes the high level interactions between **nbn** and your organisation that may arise from submitting a Connect Order selecting End User Installation – FTTC (**nbn** Dispatched).

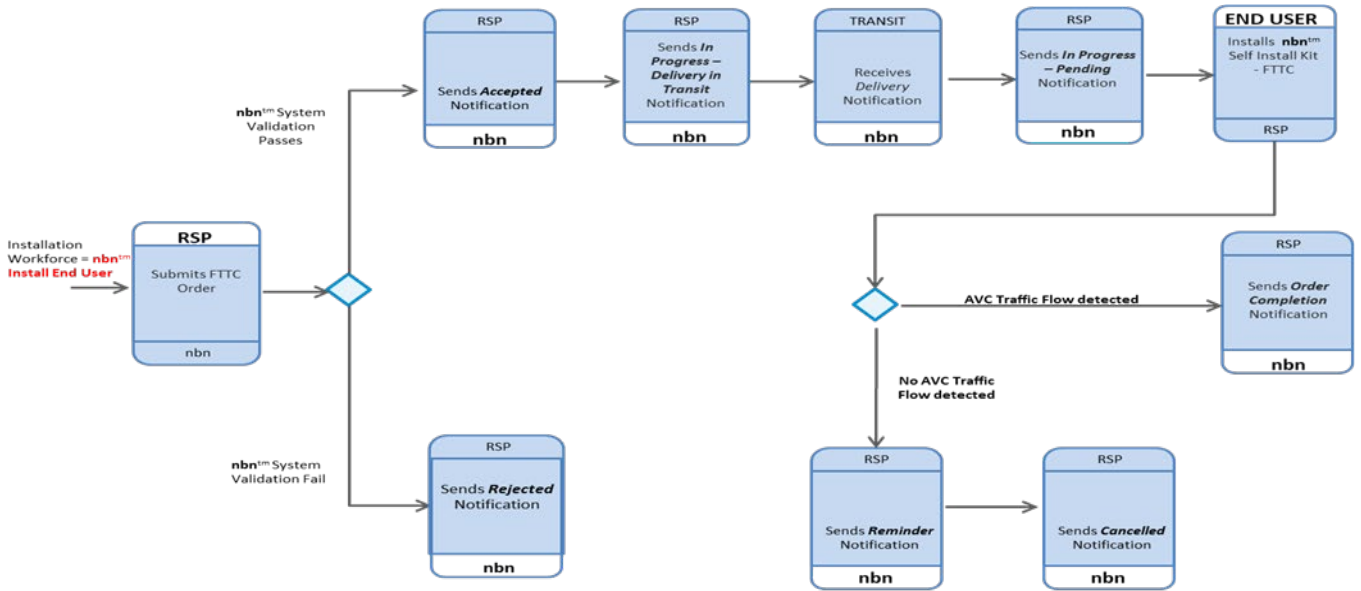

Who	Activity
Your organisation...	Must provide the Contracted End User details as required.
nbn...	<ul style="list-style-type: none"> Sends Order Accepted Notification and updates the Order Status to In Progress. Dispatches the Self-Install Kit – FTTC to the Contracted End User’s delivery address and updates the Order Status to In Progress – delivery in transit. (When nbn dispatches the Self-Install Kit – FTTC) Updates the order with the in transit date and time and sends a delivery in transit notification containing the Order ID and shipping tracking identifier. Upon delivery of the Self-Install Kit - FTTC, updates the Order Status to "In Progress - Pending", awaiting successful installation and confirmation of AVC Traffic Flow.
Your organisation...	<p>(If the Order Status is "In Progress - Pending")</p> <ul style="list-style-type: none"> Must ensure that the Contracted End User promptly installs the Self Install Kit - FTTC in accordance with the accompanying installation instructions. If necessary, provides remote assistance to Contracted End User with respect to troubleshooting the installation of the Self Install Kit - FTTC.

4.6.7.3 Order Completion

The following table describes the high level interactions between **nbn** and your organisation that may occur during order completion process.

Who	Activity
nbn...	<p>(For a Service Class 31 nbn® Copper Pair, a Service Class 32 nbn® Copper Pair, a Service Class 33 nbn® Copper Pair and a Service Class 34 nbn® Copper Pair)</p> <ul style="list-style-type: none"> Will progress the Order Status to Complete and send an Order Complete Notification at the time AVC Traffic Flow is detected in respect of the nbn® Ethernet (FTTC) supplied to the Premises. Will send reminder notifications while an Order Status is "In Progress - Pending".

Who	Activity
Your organisation...	<p>(For a Service Class 31 nbn[®] Copper Pair, a Service Class 32 nbn[®] Copper Pair, a Service Class 33 nbn[®] Copper Pair and a Service Class 34 nbn[®] Copper Pair)</p> <ul style="list-style-type: none"> • Must contact the Contracted End User promptly to ensure necessary end user action is taken to progress the installation to complete or to amend the order by contacting nbn. • If necessary, provide remote assistance to Contracted End User with respect to troubleshooting the installation where possible.

4.6.7.4 No Traffic Flow by end of Pending Period

The following table describes the high level interactions between **nbn** and your organisation where no AVC Traffic Flow is detected in respect of the **nbn**[®] Ethernet (FTTC) supplied to the Premises within 20 Business Days of the Order Status being updated to **"In Progress Pending"**.

Who	Activity
nbn...	<p>(Where your organisation has not requested an extension of the 20 Business Day period (see below)) If no AVC Traffic flow is detected in respect of the nbn[®] Ethernet (FTTC) supplied to the Premises within 20 Business Days of the Order Status being updated to "In Progress Pending", will progress the Order to a status of Cancelled and send an Order Cancelled Notification.</p>
Your organisation...	<p>May request two extensions of 30 Business Days for the In Progress - Pending status, while awaiting AVC Traffic Flow data detection in respect of the nbn[®] Ethernet (FTTC) supplied to the Premises.</p>

4.6.7.5 Recovery of faulty or unused Self-Install Kit – FTTC

See the **Supply Terms for the Self-Install Kit – HFC & FTTC**, for details relating to returning faulty or unused Self-Install Kit - FTTC to **nbn**.

This section describes the activities required to recover Self-Install Kit - FTTC from a Contracted End User's Premises.

Installation Option	Recovery of unused or faulty Self-Install Kit – FTTC
nbn Professional Installation - FTTC	<p>The nbn[®] installation technician will collect the faulty or unused Self-Install Kit – FTTC supplied via any installation option when attending the Premises.</p>
RSP Professional Installation – FTTC	<p>Your organisation’s installation technician must collect the faulty or unused Self-Install Kit – FTTC from the Premises.</p> <p>Refer to the Supply Terms for the Self-Install Kit – HFC & FTTC, for details of the returns process.</p>
End User Installation – FTTC (RSP Dispatched)	<p>Refer to the Supply Terms for the Self-Install Kit – HFC & FTTC, for details of the returns process.</p>

Installation Option	Recovery of unused or faulty Self-Install Kit – FTTC
End User Installation – FTTC (nbn Dispatched)	Your organisation must ensure the Contracted End User posts the unused or faulty Self-Install Kit - FTTC to nbn using the return address label in the Self-Install Kit – FTTC.

4.7 Rearranging/Removing/Repairing Connecting Equipment

FIBRE

WIRELESS

SATELLITE

HFC

FTTC

This section applies to **nbn**® Ethernet (Fibre), **nbn**® Ethernet (Wireless), **nbn**® Ethernet (Satellite), **nbn**® Ethernet (HFC) and **nbn**® Ethernet (FTTC).

After **nbn** has installed the Connecting Equipment at a Premises, there may be a need for that equipment to be rearranged, removed, or repaired.



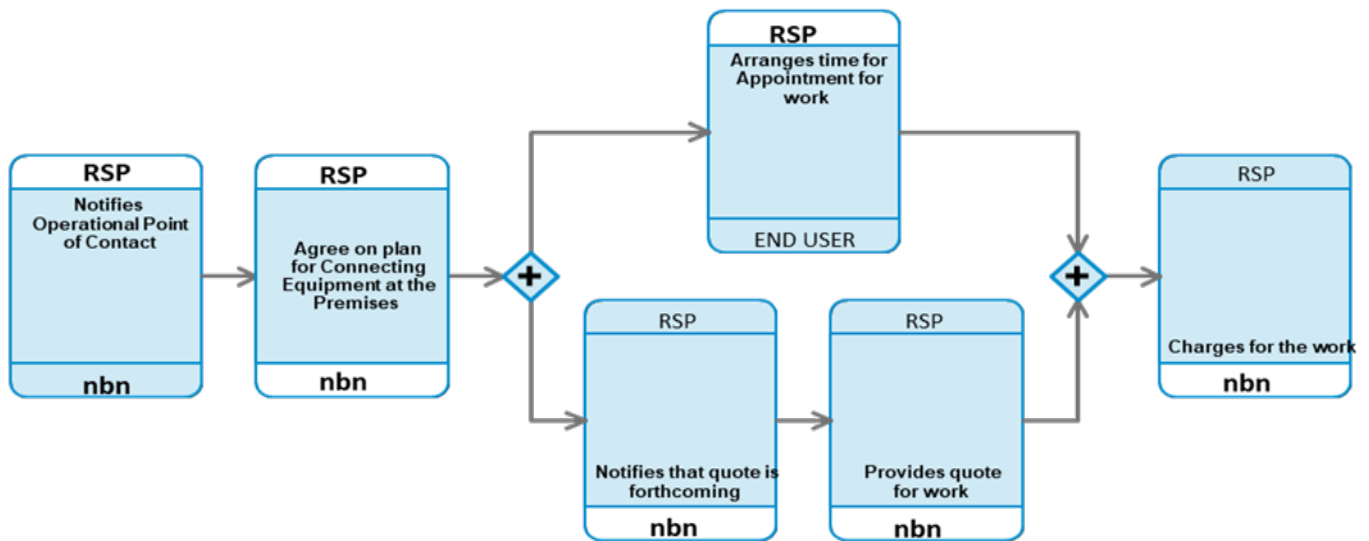

4.7.1 Interactions: Rearrangement, Removal or Repair

Subject to the matters set out in the [Head Terms](#), the following diagram and table illustrate the interactions that may occur between your organisation, **nbn** and Contracted End Users that relate to the rearrangement, removal and repair of Connecting Equipment.

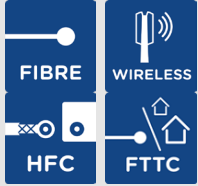
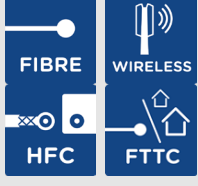

Description

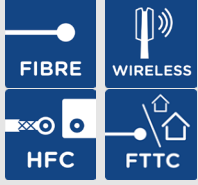
Who	Activity
Your organisation...	Must ensure that End Users promptly notify your organisation whenever they become aware of any material damage to Connecting Equipment.
Your organisation...	<i>(Whenever your organisation is aware of any material damage to Connecting Equipment)</i> Must promptly notify the relevant nbn ® Operational Point of Contact (as specified in the Contact Matrix).

Who	Activity
Your organisation and nbn ...	Agree on a plan for rearrangement, removal or repair of the Connecting Equipment at the Premises.
nbn ... 	Informs the Contracted End User that nbn will provide a quote for the rearrangement, removal, or repair.
nbn...	Determines the Charges that will apply in connection with the rearrangement, removal, or repair of Connecting Equipment.
nbn ... 	(After determining the Charges that will apply in connection with the rearrangement, removal, or repair of Connecting Equipment) Provides the Contracted End User with a quotation for the Charges, and advises them that your organisation may bill them for these Charges.
nbn ... 	(After determining the Charges that will apply in connection with the rearrangement, removal, or repair of Connecting Equipment) Provides your organisation with a quotation for the Charges.
Your organisation... 	Must contact the Contracted End User to arrange an Appointment to perform the rearrangement, removal, or repair work at the Contracted End User's Premises. What if the Contracted End User does not consent to an Appointment? nbn will not be required to complete the rearrangement, removal or repair.
Your organisation... 	<ul style="list-style-type: none"> Reserves an Appointment (or provides the Appointment ID if previously reserved) in respect of the rearrangement, removal, or repair work at the Contracted End User's Premises. Informs the Appointment Representative of the expected timeframe for completion of the rearrangement, removal, or repair work, based on the Service Levels or Operational Targets (as applicable) for the Premises. Informs the Appointment Representative that nbn will, within two Business Days of your organisation submitting the order with a valid Appointment ID, contact them to schedule an Actual Appointment. Provides any additional Appointment Representative contact details requested by nbn when reserving the Appointment. Informs the Appointment Representative of the details of the quote provided by nbn and obtains the consent of the Appointment Representative to the details of that quote. Your organisation must notify nbn as to whether both your organisation and the Appointment Representative consent to the details of the quote. <p>Note: When your organisation reserves an Appointment for rearrangement, removal or repair of Connecting Equipment, your organisation is reserving modification capacity (that is, the reserved Appointment block may not be the date that the modification or Actual Appointment will occur).</p>
nbn ... 	Contacts the Appointment Representative to arrange an Actual Appointment to perform the rearrangement, removal, or repair work at the Contracted End User's Premises. Notifies your organisation of the Actual Appointment date and time via the nbn ® Service Portal.

Who	Activity
	<p>What if the Appointment Representative does not consent to an Actual Appointment?</p> <p>nbn will not be required to complete the rearrangement, removal or repair.</p>
nbn ...	<p>(Before commencing work, and after obtaining the Contracted End User's acknowledgement directly or via your organisation, as applicable, that they will pay your organisation the rearrangement, removal or repair Charges) Charges your organisation for the work, in accordance with the WBA.</p>



Note: Where rearrangement, removal or repair proceeds, **nbn** will provide your organisation with the quote for the completed work after the generation of the invoice containing the Charges.

4.7.2 Equipment Modification

nbn will approve any Equipment Modification if it is deemed to be one of the following:

- A health, safety, and/or environment issue
- Related to the quality of the Installation.

nbn may perform the Equipment Modification for reasons other than those set out above where requested by your organisation (including for cosmetic reasons and convenience). If **nbn** accepts a request to perform the Equipment Modification in these circumstances, then your organisation must pay any applicable Charges set out in the [nbn® Ethernet Price List](#).

4.8 Changes of Access Technology

This section describes the interactions that may occur where **nbn** supplies an **nbn**® Ethernet Ordered Product to your organisation at a Premises using an access technology that forms part of the **nbn**® Network (**Original Access Technology**) and determines to make that Premises Serviceable by a different access technology (**Subsequent Access Technology**).

4.8.1 Process Initiation

nbn may perform the relevant process outlined in section [4.8.2 COAT Process](#) below where **nbn** determines:

- a Fibre Connect Connection is to be conducted (subject to accepting a Fibre Connect Eligible Order) in the following scenarios:

Ordered Product supplied by...	nbn determines to make the Premises Serviceable by...
FTTN Network	<ul style="list-style-type: none"> • Fibre Network
FTTC Network	<ul style="list-style-type: none"> • Fibre Network

Or

- a Network Activity (COAT) is to be conducted as part of Network Activity under section [5.2.8 Network Activity](#);

Or

- to conduct a Proactive COAT in the following scenarios:

Ordered Product supplied by...	nbn determines to make the Premises Serviceable by...
FTTN Network	<ul style="list-style-type: none"> • FTTC Network; or • Fibre Network
Wireless Network	<ul style="list-style-type: none"> • FTTN Network; • FTTC Network; or • Fibre Network
FTTC Network	<ul style="list-style-type: none"> • Fibre Network
FTTB Network	<ul style="list-style-type: none"> • Fibre Network
Satellite Network	<ul style="list-style-type: none"> • Wireless Network; or • Fibre Network

Note:



nbn may also specify circumstances where your organisation or a third party may request a change to the Original Access Technology, for example, “**nbn** Select” and “Technology Choice”. If your organisation or a third party requests a change to the Original Access Technology under one of these programs, then **nbn** may consider such request on a case-by-case basis and may determine to make the Premises Serviceable by a different access technology in response to that request. When this occurs, the processes and associated activities that follow **nbn** making the relevant Premises Serviceable by the Subsequent Access Technology are as set out in section 4.8.2.1.

4.8.2 COAT Process

4.8.2.1 Network Activity COAT or Proactive COAT

The process and associated activities **nbn** and your organisation must perform in respect of a Network Activity (COAT) or Proactive COAT are defined in the table below:



Who	Activity
nbn...	Updates the Historical Footprint List to reflect any planned changes to the Original Access Technology used to serve one or more Premises.
Your organisation or nbn	May notify the relevant Contracted End User of the proposed change to the Original Access Technology used to serve the relevant Premises.
nbn...	<ul style="list-style-type: none"> • Performs the necessary activities required to make each relevant Premises Serviceable by the relevant Subsequent Access Technology. • <i>(For any in-flight orders for nbn[®] Ethernet Ordered Products ordered but yet to be supplied to the relevant Premises using the Original Access Technology)</i> Changes the Order Status to In Progress – Pending.
Your organisation...	<i>(For any in-flight orders for nbn[®] Ethernet Ordered Products ordered but yet to be supplied to the relevant Premises using the Original Access Technology)</i> Must cancel the order within 5 Business Days of nbn changing the Order Status of the relevant order to In Progress – Pending .

Who	Activity
nbn...	<ul style="list-style-type: none"> Updates the Historical Footprint List to specify: <ul style="list-style-type: none"> the date that each relevant Premises is Serviceable by the relevant Subsequent Access Technology; and the relevant Changeover Period End Date in respect of each such Premises, which will be no less than 18 months from date that nbn makes the Premises Serviceable by a Subsequent Access Technology. Changes the Service Class of each relevant Premises to reflect the Subsequent Access Technology
Your organisation or nbn...	<p>May contact the relevant Contracted End User to notify them of a completed change to the Subsequent Access Technology used to serve the relevant Premises and to facilitate the transition from the Original Access Technology to the Subsequent Access Technology.</p>
Your organisation...	<ul style="list-style-type: none"> May submit a Connect Order for nbn[®] Ethernet supplied by the Subsequent Access Technology in respect of the relevant Premises. May submit a Disconnect Order for any nbn[®] Ethernet Ordered Products supplied to the relevant Premises using the Original Access Technology. Must not place a Connect Order, other than a Service Transfer Order, in respect of nbn[®] Ethernet supplied to the relevant Premises using the Original Access Technology. May request an extension to the relevant Changeover Period End Date.
nbn...	<ul style="list-style-type: none"> <i>(In respect of nbn[®] Ethernet Ordered Products supplied to your organisation at the relevant Premises using the Original Access Technology, upon the earlier of your organisation submitting a Disconnect Order or the Changeover Period End Date)</i> Disconnects all such Ordered Products. <i>(Upon disconnection of all ordered products supplied by means of the Original Access Technology)</i> May make the Premises unserviceable for the purpose of the Original Access Technology. <div data-bbox="357 1160 1469 1323" style="background-color: #fff9c4; padding: 10px;"> <p> Important: nbn's right to make a Premises unserviceable for the purpose of the Original Access Technology applies whether or not there are any in-flight orders for nbn[®] Ethernet supplied by the Original Access Technology that are yet to pass their Point of No Return.</p> </div>
Your organisation...	<div data-bbox="357 1361 1469 1653" style="background-color: #fff9c4; padding: 10px;"> <p> Important: Once nbn updates the Service Class of a Premises to reflect a Subsequent Access Technology, the Original Access Technology in respect of that Premises may not appear in the nbn[®] Platform Interfacing Service if your organisation performs a Site Qualification Enquiry or Enhanced Site Qualification Enquiry (even while the Premises remains Serviceable under the Original Access Technology).</p> <p>Your organisation may place an order for nbn[®] Ethernet supplied by the Subsequent Access Technology immediately after nbn updates the Service Class.</p> </div>

4.8.2.2 Fibre Connect Connection

The process and associated activities **nbn** and your organisation must perform in respect of a Fibre Connect Connection are defined in the table below:

Who	Activity
nbn...	Updates the Historical Footprint List to reflect any plans to make Fibre Connect Connections available in respect of one or more Premises.
Your organisation or nbn	May notify the relevant Contracted End User of the proposed plans to make a Fibre Connect Connection available in respect of the relevant Premises.
nbn...	<ul style="list-style-type: none"> Performs the necessary activities required to make Fibre Connect Connections available at each relevant Premises. Updates the Historical Footprint List to specify the date on which a Fibre Connect Connection becomes available at each relevant Premises.
Your organisation...	<ul style="list-style-type: none"> May perform a Site Qualification Enquiry in respect of the relevant Premises in accordance with section 4.3.1 Site Qualification Enquiries (If a Site Qualification Enquiry indicates that a Premises is eligible for a Fibre Connect Connection) may submit a Connect Order for nbn[®] Ethernet supplied by the Subsequent Access Technology in respect of the relevant Premises in accordance with section 4.5.2.1 Interactions: Connect Order. <div style="background-color: #fff9c4; padding: 10px; margin-top: 10px;"> <p> Important: If your organisation submits a Connect Order for nbn[®] Ethernet supplied by the Subsequent Access Technology at a Premises in respect of which a Fibre Connect Connection is available, nbn may reject a range of orders in respect of that Premises as follows:</p> <ul style="list-style-type: none"> that Connect Order, if your organisation has not entered into the Fibre Connect Supply Terms with nbn; that Connect Order, if it is not a Fibre Connect Eligible Order (as defined below); that Connect Order, if there are any in-flight connect orders for nbn[®] Ethernet supplied by the Original Access Technology at that Premises; any subsequently received Connect Orders for nbn[®] Ethernet supplied by the Original Access Technology; and any additional Connect Orders for nbn[®] Ethernet supplied by the Subsequent Access Technology, until the first Connect Order is completed. </div>
nbn...	<ul style="list-style-type: none"> (After nbn accepts a Fibre Connect Eligible Order) Changes the Service Class of the relevant Premises to Service Class 1. (If your organisation cancels an in-flight Fibre Connect Eligible Order) Changes the Service Class of the relevant Premises back to the Service Class which applied at the time of the relevant Fibre Connect Eligible Order.
nbn...	<p>(If nbn has completed a Fibre Connect Eligible Order):</p> <ul style="list-style-type: none"> Updates the Historical Footprint List to specify the relevant Changeover Period End Date in respect of the relevant Premises, which will be no less than 18 months from the date on which nbn completes the Fibre Connect Eligible Order Changes the Service Class of the relevant Premises to reflect the Subsequent Access Technology
Your organisation or nbn...	<ul style="list-style-type: none"> May contact the relevant Contracted End User to notify them of the completed change to the access technology used to serve the relevant Premises and to provide any information or assistance associated with that change.

Who	Activity
<p>Your organisation...</p>	<ul style="list-style-type: none"> • May submit a Disconnect Order for any nbn[®] Ethernet Ordered Products supplied to the relevant Premises using the Original Access Technology. • Must not place a Connect Order, other than a Service Transfer Order, in respect of nbn[®] Ethernet supplied to the relevant Premises using the Original Access Technology. • May request an extension to the relevant Changeover Period End Date.
<p>nbn...</p>	<ul style="list-style-type: none"> • <i>(In respect of nbn[®] Ethernet Ordered Products supplied to your organisation at the relevant Premises using the Original Access Technology, upon the earlier of your organisation submitting a Disconnect Order or the Changeover Period End Date) Disconnects all such Ordered Products.</i> • <i>(Upon disconnection of all ordered products supplied by means of the Original Access Technology) May make the Premises unserviceable for the purpose of the Original Access Technology.</i> <div data-bbox="357 696 1369 860" style="background-color: #fff9c4; padding: 10px;"> <p> Important: nbn's right to make a Premises unserviceable for the purpose of the Original Access Technology applies whether or not there are any in-flight orders for nbn[®] Ethernet supplied by the Original Access Technology that are yet to pass their Point of No Return.</p> </div>
<p>Your organisation...</p>	<div data-bbox="357 904 1369 1211" style="background-color: #fff9c4; padding: 10px;"> <p> Important: Once nbn updates the Service Class of a Premises to reflect a Subsequent Access Technology, the Original Access Technology in respect of that Premises may not appear in the nbn[®] Platform Interfacing Service if your organisation performs a Site Qualification Enquiry or Enhanced Site Qualification Enquiry (even while the Premises remains Serviceable under the Original Access Technology).</p> <p>Your organisation may place further orders for nbn[®] Ethernet supplied by the Subsequent Access Technology immediately after nbn completes the Fibre Connect Eligible Order.</p> </div>

 **Important:** If your organisation places a Fibre Connect Eligible Order, the Installation required to make the relevant Premises serviceable by the Subsequent Access Technology will be an FTTN/C Fibre Upgrade Installation.

Module 5: Assurance



5.1 In This Module

Assurance covers the following interactions between your organisation and **nbn**:

- Diagnosis, reporting, investigation and repair of Service Faults and Performance Incidents
- Notification, scheduling and performance of Outages.

5.2 RSP-Reported Fault Rectification



Important: Trouble Tickets must not be raised prior to following each applicable process set out in this [WBA Operations Manual](#). See section [5.2.2 Trouble Tickets](#)

When your organisation becomes aware of a potential fault or incident affecting an Ordered Product, it must (as soon as reasonably practicable) perform the test and diagnostic tasks specified in the **Test & Diagnostic Checklist** (available on the **nbn**[®] Service Portal), including submitting a Service Health Summary Enquiry if necessary, to identify whether or not the potential fault or incident is likely to be a Service Fault or Performance Incident.

Where the **Test & Diagnostic Checklist** requires your organisation to perform a Service Health Summary Enquiry, your organisation must first:

- use reasonable endeavours to confirm with the relevant Contracted End User that there is a potential fault or incident affecting the relevant RSP Product or Downstream Product (see section [5.2.1.1 Service Health Summary Enquiry](#)); and
- (if the *Service Health Summary Tool* is available) perform the Service Health Summary Enquiry.

Once your organisation has completed the steps above, your organisation must then perform any other test and diagnostics tasks set out in the **Test & Diagnostic Checklist**, using the Service Health Summary Information (if applicable).

Note: The Service Health Summary Enquiry is only available for certain access technologies and traffic classes as set out in the **Test & Diagnostic Checklist** from time to time. See section [5.2.1.1 Service Health Summary Enquiry](#)

Following this evaluation, your organisation must (as soon as reasonably practicable) raise a Trouble Ticket for the fault or incident if (based on the results of the diagnostic tasks and test specified in the **Test & Diagnostic Checklist**) it reasonably considers that the fault or incident is either a Service Fault or Performance Incident.

Notes:

- When your organisation has ordered a V-NNI, it must, prior to raising a Trouble Ticket in respect of an actual or potential fault or incident, contact the relevant NNI Link RSP and confirm that the fault or incident is not related to backhaul or the Linked NNI. If the fault or incident relates to the Linked NNI, the relevant NNI Link RSP should raise a Trouble Ticket.
- When your organisation has overbooked CVC TC-4 in respect of an NNI (i.e. your organisation has acquired CVC TC-4 Product Components that, in the aggregate, exceed the bandwidth of the associated NNI), it must, prior to raising a Trouble Ticket in respect of an actual or potential fault or incident, take reasonable steps to ensure that the fault or incident is not related to overbooking.

For the avoidance of doubt, if the fault or incident relates to a Type 2 Facility, your organisation must only contact **nbn**, and not an Underlying Facility Provider, regarding the fault or incident.

5.2.1 Test & Diagnostics

The **nbn**[®] Service Portal and B2B Access provide test and diagnostics tools of the type detailed in this section [5.2.1 Test & Diagnostics](#). A specific testing & diagnostic tool may only be available via one or both of these channels, as detailed in the *Test & Diagnostics Guide*.

Your organisation should refer to the *Test & Diagnostic Checklist* (available via the **nbn**[®] Service Portal) and the *Test & Diagnostics Guide* (provided to your organisation) when reviewing the results of a Service Health Summary Enquiry, Diagnostic Status Test and Network Test.

The *Test & Diagnostics Guide* is a companion document which focuses on how to use **nbn**[®] test & diagnostic tools, and how to interpret the test and diagnostic results. It also includes Line Rate, line stability and availability thresholds used to determine the results of a Service Health Summary Enquiry.

The content in the *Test & Diagnostics Guide* is applicable to both the **nbn**[®] Service Portal and B2B Access. Your organisation can obtain a copy of the latest release of the *Test & Diagnostics Guide* by contacting the **nbn**[®] Relationship Point of Contact or via the **nbn**[®] Service Portal.



For **nbn**[®] Ethernet (FTTB) or **nbn**[®] Ethernet (FTTN) the *Test & Diagnostic Checklist* and *Test & Diagnostics Guide* will assist your organisation to determine the Trouble Ticket Fault Location. Refer to section [6.8.1 Trouble Ticket – Fault Location](#).



Important: The *Test & Diagnostic Checklist* and *Test & Diagnostics Guide* do not form part of this document or the [WBA](#).

The Transaction Manager applies to Test and Diagnostic Transactions – please refer to the [Service Description for the **nbn**[®] Platform Interfacing Service](#) for further details.

5.2.1.1 Service Health Summary Enquiry



Important: This section only applies in respect of access technologies and traffic classes for which the Service Health Summary Tool is available.

Please see the *Test & Diagnostic Checklist* for information regarding:

- the access technologies and traffic classes for which the Service Health Summary Tool is available; and
- the Service Elements of the **nbn**[®] Platform Interfacing Service that your organisation can use to run a Service Health Summary Enquiry.

Before raising a Trouble Ticket in relation to a potential fault or incident, your organisation must use the Service Health Summary Tool (if available) to run a Service Health Summary Enquiry, via the **nbn**[®] Service Portal or via B2B Access using APIs, to gather information about the potential fault or incident and to identify whether or not the potential fault or incident is likely to be a Service Fault or Performance Incident.

A Service Health Summary Enquiry can only be undertaken if:

- a Contracted End User has raised a potential fault or incident with your organisation; or
- your organisation has identified a potential fault or incident with respect to an Ordered Product and has used reasonable endeavours to confirm (or is in the process of confirming) with the relevant Contracted End User that there is a potential fault or incident affecting the relevant RSP Product or Downstream Product.



Important: The Service Health Summary Quota applies to the Service Health Summary Enquiries – please refer to the [Service Description for the nbn® Platform Interfacing Service](#) for further details. **nbn** may restrict the hours of operation that your organisation may perform a Service Health Summary Enquiry as further described in the *Test & Diagnostics Guide*. Despite anything else in this [WBA Operations Manual](#), your organisation is not required to submit a Service Health Summary Enquiry if the Service Health Summary Tool is not available at the time your organisation is performing the test and diagnostics tasks set out in the *Test & Diagnostic Checklist*.

The Service Health Summary Information includes the following categories of information where available, and such other relevant information as determined by **nbn** from time to time:

Connectivity Summary

To help your organisation troubleshoot potential connectivity issues relating to an Ordered Product, the “**Connectivity Summary**” provides information on the operational/connection status of elements related to the Ordered Product, such as the Ordered Product’s state (sync) (for **nbn**® Ethernet (FTTB) and **nbn**® Ethernet (FTTN)) and the last time it changed, with relevant details and indicators that show whether the parameters are within expected ranges, and when the information was last updated.

CPE Summary

To help your organisation troubleshoot potential issues relating to RSP Equipment or End User Equipment (commonly referred to as “CPE”), the “**CPE Summary**” provides information on certain RSP Equipment and End User Equipment that **nbn** can see is used in connection with the **nbn**® Network, with details and indicators that show whether certain features are compatible with the **nbn**® Network.

Performance Summary

To help your organisation troubleshoot potential issues relating to the performance of an Ordered Product or the Line Rate of a relevant link, the “**Performance Summary**” will provide your organisation with a summary of the Line Rate measurements for the relevant Premises, and factors that may be impacting the performance of the Ordered Product. The performance summary will also show whether the Line Rate measurements are within expected ranges, and when the information provided in the Performance Summary was collected by **nbn**.

Stability Summary

To help your organisation troubleshoot potential issues relating to the stability of an Ordered Product, the “**Stability Summary**” provides a summary of the stability measurements of the Ordered Product and thresholds for stability counters (such as dropouts), with relevant details and indicators to show whether the measurements are within expected ranges. The Stability Summary also shows when the information provided in the Stability Summary was collected by **nbn**.

The Service Health Summary Enquiry will provide a next suggested action based on the Service Health Summary Information. Examples of these suggested actions could be as follows:

- The Ordered Product is affected by a Service Fault, and the suggested action is for your organisation to raise a Service Fault Trouble Ticket.
- The Ordered Product is affected by a Performance Incident, and the suggested action is for your organisation to raise a Performance Incident Trouble Ticket.
- The Ordered Product is not affected by a Service Fault or Performance Incident, and no further action is suggested.

5.2.1.2 Diagnostic Status Tests

Your organisation may submit a request for a Diagnostic Status Test through the **nbn**® Service Portal or B2B Access.

The following table defines the different Test Status states that apply to a Diagnostic Status Test:

Test Status	Related Events and Activities
New	The request for a Diagnostic Status Test has been submitted.
Complete	The Diagnostic Status Test is complete.
Incomplete	A problem was encountered when conducting the Diagnostic Status Test.

5.2.1.3 Network Tests

Your organisation may submit a request for a Network Test through the **nbn**® Service Portal or B2B Access. When a Network Test reaches its Point of No Return, your organisation cannot cancel it.

Important: **nbn** may restrict the hours of operation that your organisation may perform a Network Test as further described in the *Test & Diagnostics Guide*.

The following diagram illustrates the lifecycle of a Network Test, including the Test Status states that may apply:

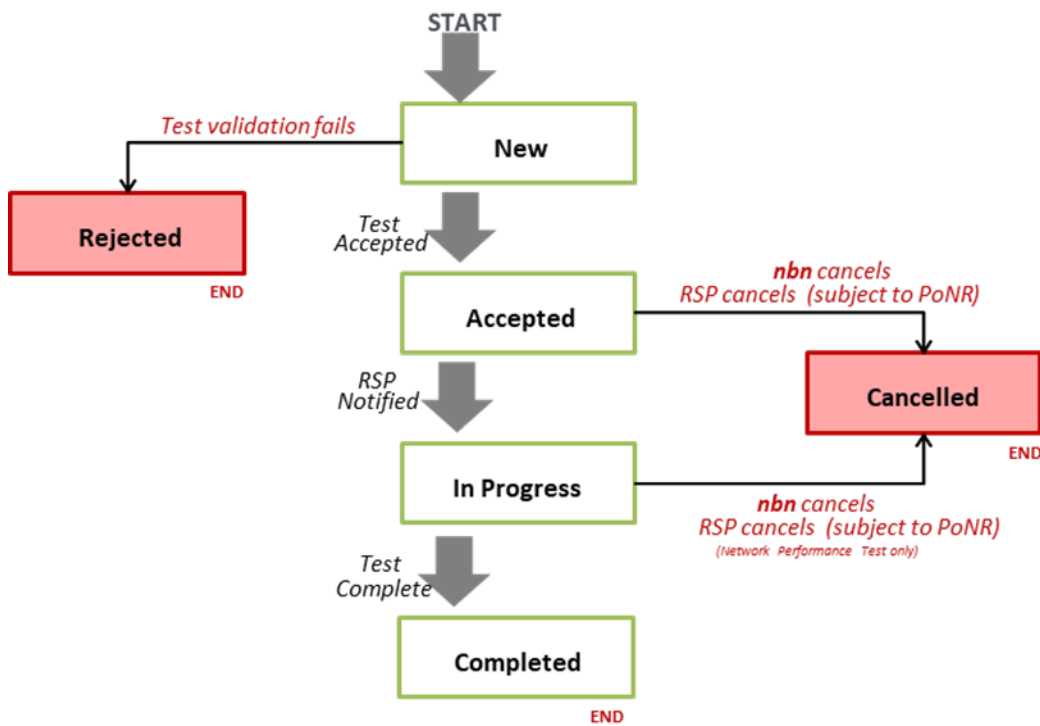

The following table defines the different Test Status states that apply to a Network Test.

Test Status	Related Events and Activities
New	The request for a Network Test has been submitted.
Accepted	<p>Event</p> <p>The Network Test request is received by nbn, with no issues encountered.</p> <p>Activities</p> <ul style="list-style-type: none"> nbn updates the Test Status to Accepted nbn provides a unique Test ID, Service Health Summary Enquiry ID or both (as required under the <i>Test & Diagnostic Checklist</i>) (B2B Access only) nbn sends a Test Accepted Notification to your organisation nbn schedules the Network Test for execution





Test Status	Related Events and Activities
In Progress	<p>Event nbn commences Network Test execution.</p> <p>Activities</p> <ul style="list-style-type: none"> nbn updates the Test Status to In Progress (B2B Access only) nbn sends a Test In Progress Notification to your organisation nbn performs the necessary Network Test activities
Complete	<p>Event nbn completes Network Test execution.</p> <p>Activities</p> <ul style="list-style-type: none"> nbn updates the Test Status to Completed (B2B Access only) nbn sends a Completed Notification, containing the test results, to your organisation
Rejected	<p>Event nbn reasonably determines that the Network Test request is invalid due to one or more of the following circumstances:</p> <ul style="list-style-type: none"> The Network Test request submitted includes invalid information The Network Test request fails to meet the relevant Business Rules detailed in the <i>Test & Diagnostics Guide</i> The Network Test request submitted is otherwise defective <p>Activities</p> <ul style="list-style-type: none"> nbn updates the Test Status to Rejected (B2B Access only) nbn sends a Rejected Notification to your organisation nbn provides your organisation with reasons for rejecting the Network Test
Cancelled	<p>Event Occurs in the following situations:</p> <ul style="list-style-type: none"> Your organisation submits manually a 'cancel' test request for, or nbn cancels, an in-flight Network Test that has not passed its Point of No Return nbn is otherwise currently unable to proceed with executing the Network Test <p>Activities</p> <ul style="list-style-type: none"> nbn updates the Test Status to Cancelled (B2B Access only) nbn sends a Cancelled Notification to your organisation nbn provides your organisation with reasons for cancelling the Network Test

5.2.2 Trouble Tickets

Trouble Ticket Status: Descriptions

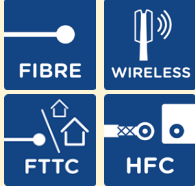
Each Trouble Ticket will have a Trouble Ticket Status, as indicated by its current status message. The following table provides a high level explanation of each Trouble Ticket Status:

Exception: Trouble Tickets for Battery Missing Alarms and Replace Battery Alarms have different statuses. The following sections, including sections on resolution and closure of Trouble Tickets do not apply. See section [5.2.5.1 Battery Alarm Trouble Ticket Status: Descriptions](#).

Status	Description
New	<ul style="list-style-type: none"> • Trouble Ticket is raised • Trouble Ticket successfully created in the nbn[®] Service Portal or B2B Access • The Trouble Ticket awaits validation by nbn. <div data-bbox="384 304 475 394" style="border: 1px solid #0056b3; padding: 5px; margin-bottom: 10px;">  SATELLITE </div> <p>Important: Your organisation must associate a reserved Trouble Ticket Appointment at the same time as raising a Trouble Ticket in respect of the Satellite Network. nbn will attempt to schedule an Actual Trouble Ticket Appointment in accordance with section 6.3.2 New Appointment Process.</p> <div data-bbox="384 495 579 680" style="border: 1px solid #0056b3; padding: 5px; margin-bottom: 10px;"> <div style="display: flex; justify-content: space-between;"> <div style="border: 1px solid #0056b3; padding: 5px; width: 45%;">  FIBRE </div> <div style="border: 1px solid #0056b3; padding: 5px; width: 45%;">  WIRELESS </div> </div> <div style="display: flex; justify-content: space-between;"> <div style="border: 1px solid #0056b3; padding: 5px; width: 45%;">  FTTC </div> <div style="border: 1px solid #0056b3; padding: 5px; width: 45%;">  HFC </div> </div> </div> <p>Important: Your organisation must reserve a Trouble Ticket Appointment at the same time as raising a Service Fault Trouble Ticket.</p> <div data-bbox="384 786 475 875" style="border: 1px solid #0056b3; padding: 5px; margin-bottom: 10px;">  FTTB/N </div> <p>Important: For nbn[®] Ethernet (FTTB) or nbn[®] Ethernet (FTTN) see section 6.8.1 Trouble Ticket – Fault Location.</p>
Rejected	<p>The Trouble Ticket was not valid for one or more of the following reasons:</p> <ul style="list-style-type: none"> • It was incomplete • It included invalid information • It was submitted without your organisation first complying with the requirements as set out in the Test & Diagnostic Checklist • It was not submitted in accordance with this module • It failed to meet the Business Rules in respect of any relevant Ordered Product • It otherwise failed to comply with any requirement of the WBA • nbn has a right to reject the Trouble Ticket under any other provision in the WBA.
Cancelled	<ul style="list-style-type: none"> • nbn or your organisation has cancelled the Trouble Ticket • (For nbn[®] Ethernet (Satellite)) nbn has been unable to make contact with the Appointment Representative to schedule an Actual Trouble Ticket Appointment within 10 Business Days of your organisation raising a Trouble Ticket with a valid Appointment ID • nbn has a right to cancel the Trouble Ticket under any other provision in the WBA • A Trouble Ticket with the Status of Cancelled cannot be re-opened.
Acknowledged	<ul style="list-style-type: none"> • nbn has received and validated the Trouble Ticket • nbn allocates a unique Trouble Ticket ID. <div data-bbox="384 1659 1492 1740" style="background-color: #e1f5fe; padding: 10px; margin-top: 10px;"> <p>Note: Trouble Tickets may receive a Rejected Notification after an Acknowledged Notification has been sent if the Trouble Ticket failed ticket validation.</p> </div>

Status	Description
Acknowledged – Pending	<p>Trouble Ticket awaits action from your organisation before nbn has sent your organisation an Accepted Notification. nbn stops acting on the reported Service Fault or Performance Incident while the Trouble Ticket remains in this Trouble Ticket Status.</p> <p>nbn assigns a Trouble Ticket Status of Acknowledged – Pending to a Trouble Ticket under the following circumstances:</p> <ul style="list-style-type: none"> • A valid Trouble Ticket Appointment was not submitted with the Trouble Ticket where required (including where nbn determines that a Trouble Ticket Appointment is required for action on the Trouble Ticket to begin) • nbn requires additional information and/or action or assistance from your organisation for the Trouble Ticket to proceed.
In Progress	<ul style="list-style-type: none"> • nbn diagnoses and rectifies the Service Fault or Performance Incident. <p>Note: If a Trouble Ticket’s Trouble Ticket Status is updated to In Progress at a subsequent stage, then nbn continues to investigate the Service Fault or Performance Incident, (as applicable).</p>
In Progress – Pending	<p>Trouble Ticket awaits action from your organisation after nbn has sent your organisation an Accepted Notification. nbn stops acting on the Service Fault or Performance Incident while the Trouble Ticket remains in this Trouble Ticket Status.</p> <p>nbn assigns a Trouble Ticket Status of In Progress – Pending to a Trouble Ticket under the following circumstances:</p> <ul style="list-style-type: none"> • nbn determines that a Trouble Ticket Appointment is required for action on the Trouble Ticket to proceed • nbn requires additional information and/or action or assistance from your organisation for the Trouble Ticket to proceed <p>nbn requires rescheduling of the related Trouble Ticket Appointment (other than a rescheduling by nbn to arrange an Actual Trouble Ticket Appointment in respect of nbn[®] Ethernet (Satellite) in accordance with section 5.2.3.1 Interactions: Raising a Trouble Ticket with nbn).</p>
In Progress – Held	<p>One of the following circumstances has arisen:</p> <ul style="list-style-type: none"> • Trouble Ticket awaits action from nbn before nbn continues to act on the Service Fault or Performance Incident; <p>Example: Delays in nbn attending a Trouble Ticket Appointment due to bad weather.</p> <ul style="list-style-type: none"> • nbn designates that a Network Activity or Interference Mitigation is required; or • (for a Performance Incident Trouble Ticket) a Service Fault Trouble Ticket relating to the same Ordered Product has a Trouble Ticket Status of In Progress, In Progress – Pending, In Progress – Held or In Progress – Monitoring <p>Where known, nbn will provide your organisation with a proposed rectification date for the Service Fault or Performance Incident.</p>
In Progress – Monitoring	<p> Important: The processes applicable to Monitored Enhanced Faults will only apply on and from the date nbn notifies your organisation that such functionality has been introduced in accordance with the nbn[®] Ethernet Product Description.</p> <p>One of the following circumstances has arisen:</p> <ul style="list-style-type: none"> • the Monitored Enhanced Fault has been rectified; • the Performance Incident has been rectified; • in respect of a Performance Incident Trouble Ticket, the Trouble Ticket Status of a Service Fault Trouble Ticket relating to the same Ordered Product has been updated to Resolved; or • Network Activity (Rehabilitation) works have been completed, for a Network Activity that was triggered by a Trouble Ticket.

Status	Description
	The performance of the Ordered Product over the Monitoring Period will be reviewed in accordance with section 5.2.13.1 Interactions: The Monitoring Period
Resolved	<p>One of the following circumstances has arisen:</p> <ul style="list-style-type: none"> The Service Fault indicated in the Trouble Ticket has been resolved; nbn is awaiting your organisation's acknowledgement of the Resolved Notification; The Monitored Enhanced Fault or Performance Incident indicated in the Trouble Ticket has been rectified or the works associated with a Network Activity or Interference Mitigation have been finished (as applicable) and any applicable Monitoring Period has ended. nbn may be awaiting your organisation's acknowledgement of the Resolved Notification (though this will not apply in some cases, such as where a Monitoring Period has occurred for a Performance Incident or Network Activity (COAT) works have finished); <div style="background-color: #fff9c4; padding: 10px; border: 1px solid #ccc;"> <p> Important: The processes applicable to Monitored Enhanced Faults will only apply on and from the date nbn notifies your organisation that such functionality has been introduced in accordance with the nbn® Ethernet Product Description.</p> </div> <ul style="list-style-type: none"> nbn has sent your organisation a More Information Required Notification or request for assistance and the timeframe for your organisation to provide any requested information or assistance has passed without response or action from your organisation; or nbn has updated the Trouble Ticket Status of the Trouble Ticket to Resolved in accordance with section 4.5.2.2 Product Component Orders: Additional Information or section 5.2.3.1 Interactions: Raising a Trouble Ticket with nbn.
Closed	<p>One of the following circumstances has arisen:</p> <ul style="list-style-type: none"> Either nbn has received acknowledgement of a Resolved Trouble Ticket from your organisation, or any applicable timeframe for acknowledgement has passed without response from your organisation; nbn has updated the Trouble Ticket Status of the Trouble Ticket to Resolved and then immediately to Closed in accordance with section 5.2.3.1 Interactions: Raising a Trouble Ticket with nbn, including: <ul style="list-style-type: none"> in circumstances where: <ul style="list-style-type: none"> nbn has rectified a Performance Incident and the Monitoring Period has passed without a Service Fault or Performance Incident being detected; nbn has finished Network Activity (Rehabilitation) works triggered by a Trouble Ticket and the Monitoring Period has passed without a Service Fault or Performance Incident being detected; or where specified under sections 5.2.8 Network Activity or 5.2.9 Interference Mitigation or any other express provision in this WBA Operations Manual.

5.2.3 Raising, Validating and Resolving a Trouble Ticket

5.2.3.1 Interactions: Raising a Trouble Ticket with nbn

The following diagram illustrates the interaction activities between **nbn** and your organisation that can arise from the raising of a Trouble Ticket.

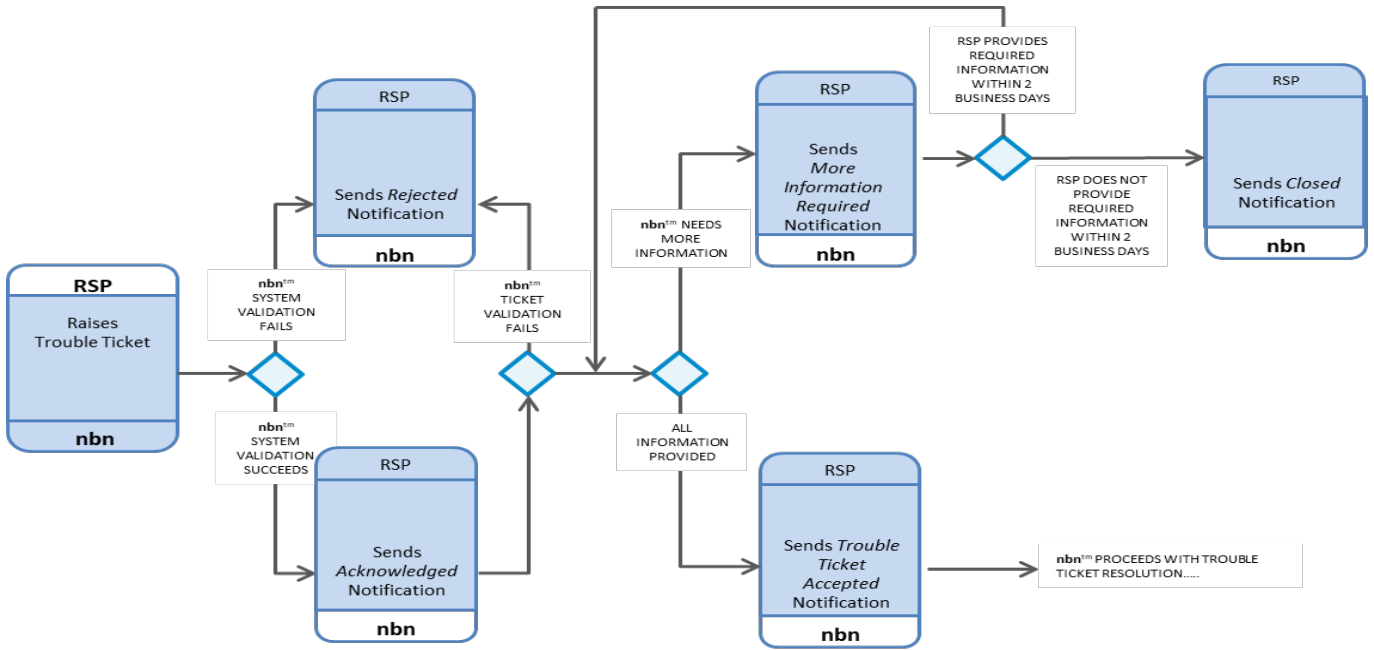

Description

The following table describes the interaction activities between **nbn** and your organisation that can arise from the raising and resolution of a Trouble Ticket.

For additional information regarding Priority Assistance Faults and Priority Assistance Incidents, please refer to section [5.2.4 Priority Assistance Trouble Tickets](#).



For additional information regarding Self Replacement – FTTC for **nbn**® Ethernet (FTTC), please refer to section [5.2.18 Self Replacement - FTTC](#).

Who	Activities
<p>Your organisation... (Non-PI Product Element is affected)</p>	<p>Uses the Test & Diagnostic Checklist available on the nbn® Service Portal to evaluate the fault and determine whether the fault is likely to be a Service Fault. If the results of the Test & Diagnostic Checklist indicate a likely Service Fault, your organisation must:</p> <ul style="list-style-type: none"> • Raise a Trouble Ticket via the nbn® Service Portal or B2B Access and reserve a Trouble Ticket Appointment; • Attach the Test ID(s) to the Trouble Ticket; and • Accurately complete the mandatory troubleshooting questions (indicated by an asterisk on the nbn® Service Portal) and other relevant questions for the Trouble Ticket (depending on fault type and the results of the use of test and diagnostic tools).
<p>Your organisation... (Only PI Product Element is affected)</p>	<p>Uses the Test & Diagnostic Checklist available on the nbn® Service Portal (including the Service Health Summary Tool (if available) on the nbn® Service Portal or via B2B Access using APIs), and determines whether or not the Ordered Product is affected by a fault or incident and, if so, whether the fault or incident is likely to be a Service Fault or a Performance Incident.</p> <p>Your organisation may then:</p> <p>(if the Service Health Summary Tool is available)</p> <ul style="list-style-type: none"> • follow the steps set out in the Standard Trouble Ticket Submission Process below; or • follow the steps set out in the Trouble Ticket Dispute Process below, but only if the Trouble Ticket was submitted after the Dispute Validation Availability Date and your organisation: <ul style="list-style-type: none"> • has not previously disputed the Service Health Summary Information in respect of the same issue affecting the same Ordered Product in the past 60 days; or • has previously disputed the Service Health Summary Information in respect of the same issue affecting the same Ordered Product in the past 60 days and nbn has agreed with each such dispute raised by your organisation).

Who	Activities
	<p><i>(if the Service Health Summary Tool is not available)</i></p> <ul style="list-style-type: none"> follow the steps set out in the Alternative Trouble Ticket Submission Process below. <p>Standard Trouble Ticket Submission Process</p> <ul style="list-style-type: none"> Raises a Trouble Ticket for the fault or incident via the nbn[®] Service Portal or B2B Access (which will be classified as a Performance Incident Trouble Ticket or Service Fault Trouble Ticket in accordance with the recommendations of the Service Health Summary Information); Except where: <ul style="list-style-type: none"> the Trouble Ticket relates to a Performance Incident affecting an nbn[®] Ethernet (Fibre) Ordered Product; or section 6.8.1 Trouble Ticket – Fault Location or section 5.2.18 Self Replacement - FTTC provides that your organisation should not reserve an Appointment, reserves a Trouble Ticket Appointment at the time the Trouble Ticket is raised using: <ul style="list-style-type: none"> (for a Service Fault Trouble Ticket) any available Appointment window; or (for a Performance Incident Trouble Ticket) an available Appointment window that starts at least 3 Business Days after the Trouble Ticket is raised; May re-run the test and diagnostic tasks as set out in section 5.2.1 Test & Diagnostics; Attaches to the Trouble Ticket the Test ID(s), the Service Health Summary Enquiry ID, and any other information as required under this Agreement, the Test & Diagnostic Checklist and the nbn[®] Operations User Guide; and Accurately completes the mandatory troubleshooting questions (indicated by an asterisk on the nbn[®] Service Portal) and other relevant questions for the Trouble Ticket (depending on fault or incident type and the results of the test and diagnostic tools). <p>Trouble Ticket Dispute Process</p> <ul style="list-style-type: none"> Raises a Trouble Ticket via the nbn[®] Service Portal or B2B Access; At the time that the Trouble Ticket is raised: <ul style="list-style-type: none"> Flags that your organisation disputes the Service Health Summary Information; Clearly indicates why your organisation disputes the Service Health Summary Information and whether your organisation considers the relevant fault or incident to be a Service Fault or Performance Incident; Provides any relevant evidence as required under the nbn[®] Operations User Guide, the Test & Diagnostic Checklist, or both, including where your organisation previously disputed the Service Health Summary Information, new evidence that justifies your organisation's subsequent dispute; Except where: <ul style="list-style-type: none"> the Trouble Ticket relates to a Performance Incident affecting an nbn[®] Ethernet (Fibre) Ordered Product; or section 6.8.1 Trouble Ticket – Fault Location or section 5.2.18 Self Replacement - FTTC provides that your organisation should not reserve an Appointment, reserves a Trouble Ticket Appointment using: <ul style="list-style-type: none"> (where your organisation determines, acting reasonably, that the Ordered Product is affected by a Service Fault) an available Appointment window that starts at least 2 Business Days after the Trouble Ticket is raised; or (where your organisation determines, acting reasonably, that the Ordered Product is affected by a Performance Incident) an available Appointment window that starts at least 3 Business Days after the Trouble Ticket is raised; Attaches to the Trouble Ticket the Test ID(s), the Service Health Summary Enquiry ID, and any other information as required under this Agreement, the Test & Diagnostic Checklist and the nbn[®] Operations User Guide; and Accurately completes the mandatory troubleshooting questions (indicated by an asterisk on the nbn[®] Service Portal) and other relevant questions for the Trouble Ticket (depending on fault or incident type and the results of the test and diagnostic tools).

Who	Activities
	<p>Alternative Trouble Ticket Submission Process</p> <ul style="list-style-type: none"> • Raises a relevant Trouble Ticket for the fault or incident via the nbn[®] Service Portal or B2B Access; • Except where section 6.8.1 Trouble Ticket – Fault Location or section 5.2.18 Self Replacement - FTTC provides that your organisation should not reserve an Appointment: <ul style="list-style-type: none"> • (where your organisation determines that the Ordered Product is affected by a Service Fault, acting reasonably and based on the outcome of the test and diagnostic tasks performed by your organisation in accordance with the Test & Diagnostic Checklist) reserves a Trouble Ticket Appointment at the time the Trouble Ticket is raised using an available Appointment window that starts at least 2 Business Days after the Trouble Ticket is raised; or • (where your organisation determines that the Ordered Product, other than an nbn[®] Ethernet (Fibre) Ordered Product, is affected by a Performance Incident, acting reasonably and based on the outcome of the test and diagnostic tasks performed by your organisation in accordance with the Test & Diagnostic Checklist) reserves a Trouble Ticket Appointment at the time the Trouble Ticket is raised using an available Appointment window that starts at least 3 Business Days after the Trouble Ticket is raised; • May re-run the test and diagnostic tasks as set out in section 5.2.1 Test & Diagnostics; • Attaches to the Trouble Ticket the Test ID(s) and any other information as required under this Agreement, the Test & Diagnostic Checklist and the nbn[®] Operations User Guide; and • Accurately completes the mandatory troubleshooting questions (indicated by an asterisk on the nbn[®] Service Portal) and other relevant questions for the Trouble Ticket (depending on fault or incident type and the results of the test and diagnostic tools). <p>Note: If your organisation disputes the Service Health Summary Information prior to the Dispute Validation Availability Date, your organisation may include details of that dispute as part of an RSP Enquiry. Please note that this will not however trigger the Trouble Ticket Dispute Process</p>
<p>nbn and/or your organisation...</p>	<p>Important Notes:</p> <ul style="list-style-type: none"> • The Test & Diagnostic Checklist is not available via B2B Access. • Your organisation must provide all of the information specified in the Trouble Ticket in relation to the Service Fault or Performance Incident (as applicable). • Your organisation must select the relevant Test ID(s), the Service Health Summary Enquiry ID where relevant, and provide any other information as required under this Agreement and the nbn[®] Operations User Guide, prior to submitting the Trouble Ticket. <p>Note: Failure to provide the relevant Test ID(s) and information may result in delays to the resolution of the Trouble Ticket (refer to section 5.2.2 Trouble Tickets and the In Progress - Pending definition).</p> • Your organisation must append any other test and/or troubleshooting results that may arise from the Test & Diagnostic Checklist to the Trouble Ticket's 'Comments' section. If the quantity of diagnostic information is too large to add to the Trouble Ticket, your organisation must forward it by email to the relevant RSP Support Centre contact address in the Contact Matrix and include the Trouble Ticket ID to ensure it is linked to the correct Trouble Ticket. • Subject to the following exceptions, your organisation must submit a Trouble Ticket in respect of each fault or incident which it reasonably believes to be either a Service Fault or a Performance Incident. • Your organisation must not raise a Trouble Ticket for a Performance Incident unless the Performance Incident affects the performance of a PI Product Element. nbn is not required to investigate or repair any such Performance Incident and may reject or

Who	Activities
	<p>cancel any such Trouble Ticket, or update the Trouble Ticket Status to Resolved, on the basis that:</p> <ul style="list-style-type: none"> • the Performance Incident is caused or contributed to by a matter that is outside the nbn[®] Network Boundaries or that is otherwise excluded from the scope of nbn[®] Ethernet; or • the Performance Incident does not affect the performance of a PI Product Element. <ul style="list-style-type: none"> • Your organisation may, but is not required to, raise a Trouble Ticket for a Performance Incident that affects the performance of a PI Product Element and is caused or contributed to by a matter that is outside the nbn[®] Network Boundaries or that is otherwise excluded from the scope of nbn[®] Ethernet. nbn may, but is not required to, investigate or repair any such Performance Incident and may reject or cancel any such Trouble Ticket, or update the Trouble Ticket Status to Resolved, on the basis that the Performance Incident is caused or contributed to by a matter that is outside the nbn[®] Network Boundaries or is otherwise excluded from the scope of nbn[®] Ethernet. • Your organisation may only raise more than one Trouble Ticket at the same time in respect of the same Ordered Product where: <ul style="list-style-type: none"> • your organisation has previously raised a Performance Incident Trouble Ticket in relation to an Ordered Product and the Ordered Product is subsequently affected by a Service Fault; or • nbn is performing a Network Activity in connection with a Trouble Ticket raised in relation to that Ordered Product and the subsequent Trouble Ticket does not relate to: <ul style="list-style-type: none"> • the Line Rate or Information Rate (PIR or CIR) at the UNI used to serve a Premises; or • a Performance Incident that gave rise to nbn performing a Network Activity. • When your organisation raises a Trouble Ticket through the nbn[®] Service Portal, B2B Access or by email for a fault or incident which it believes to be a Priority Assistance Fault or Priority Assistance Incident, where suitable appointments are not provided within the required Service Level, your organisation must follow up with a telephone call to the nbn 24/7 Priority Assistance Contact Centre (see the Contact Matrix for details). Also see the additional information in section 5.2.4 Priority Assistance Trouble Tickets. • When your organisation raises a Trouble Ticket for a Service Fault that the results of the Test & Diagnostic Checklist indicate is eligible for Self Replacement – FTTC, your organisation may, at its discretion, select the Self Replacement – FTTC option when raising the Trouble Ticket. See the additional information in section 5.2.18 Self Replacement - FTTC. • When your organisation raises a Trouble Ticket for an Enhanced Fault, then your organisation must indicate in the 'Comments' section of the Trouble Ticket that the fault is an Enhanced Fault. • If neither the nbn[®] Service Portal nor B2B Access is available, then your organisation may raise a Trouble Ticket by emailing or telephoning the relevant RSP Support Centre contact in the Contact Matrix. • If your organisation reports a fault or an incident using a method that is not set out above, nbn will not act on the fault or incident until a Trouble Ticket has been submitted correctly. • nbn may change the Test & Diagnostic Checklist, in which case nbn will make the updated Test & Diagnostic Checklist available to your organisation through the nbn[®] Service Portal. nbn will give your organisation 10 Business Days' notice of any change to the Test & Diagnostic Checklist. • nbn may update the troubleshooting, questions included in the Trouble Ticket on the nbn[®] Service Portal. nbn will provide your organisation with 10 Business Days' notice of any such change. • Your organisation must not raise a Trouble Ticket for a fault related to the Information Rates (PIR and CIR) of an nbn[®] Ethernet (FTTB) or nbn[®] Ethernet (FTTN) Ordered Product that is operating with a Repair Profile. • Your organisation must not raise a Trouble Ticket for an Ordered Product in relation to an Interference Event if nbn has designated that the Ordered Product requires Interference Mitigation.

Who	Activities
	<ul style="list-style-type: none"> • If your organisation has ordered an NNI Link and raises a Trouble Ticket, your organisation consents to nbn disclosing the existence and details of that Trouble Ticket to the relevant Downstream V-NNI RSP. • If your organisation has ordered a V-NNI and raises a Trouble Ticket, your organisation consents to nbn disclosing the existence and details of that Trouble Ticket to the relevant Upstream NNI Link RSP. • See section 4.5.2.2 Product Component Orders: Additional Information in relation to AVC TC-2 bandwidth profiles, which sets out circumstances in which your organisation must not raise certain types of Trouble Tickets and nbn may reject certain types of Trouble Tickets. <div data-bbox="373 479 1469 618" style="background-color: #fff9c4; padding: 5px;">  For nbn® Ethernet (FTTB) or nbn® Ethernet (FTTN) see section 6.8.1 Trouble Ticket – Fault Location </div> <div data-bbox="373 651 1469 875" style="background-color: #fff9c4; padding: 5px;">  Important: When your organisation reserves a Trouble Ticket Appointment in respect of nbn® Ethernet (Satellite) your organisation is reserving assurance capacity (that is, the reserved Trouble Ticket Appointment may not be the date that the Trouble Ticket Appointment will occur). nbn will contact the Appointment Representative to schedule the Actual Trouble Ticket Appointment in accordance with section 6.3.2 New Appointment Process. </div>
<p>nbn...</p>	<p>Confirms whether or not the Trouble Ticket was submitted correctly and, depending on the result of the submission validation, does one of the following:</p> <ul style="list-style-type: none"> • <i>(If the Trouble Ticket was submitted correctly)</i> Sends your organisation an Acknowledged Notification, and updates the Trouble Ticket Status to Acknowledged The Acknowledged Notification will include the Trouble Ticket’s unique identifier (Trouble Ticket ID) • <i>(If the Trouble Ticket was not submitted correctly)</i> Sends your organisation a Rejected Notification if nbn rejects the Trouble Ticket, and updates the Trouble Ticket Status to Rejected If your organisation wishes to pursue the matter further, it must raise a new Trouble Ticket. <div data-bbox="373 1240 1469 1406" style="background-color: #e1f5fe; padding: 5px;"> <p>Note: Trouble Tickets may receive a Rejected Notification after an Acknowledged Notification has been sent if the Trouble Ticket failed ticket validation, including if your organisation has failed to provide the required details and evidence if it disputes the Service Health Summary Information.</p> </div>
<p>nbn... <i>(Only PI Product Element is affected)</i></p>	<p><i>(If your organisation has raised a Trouble Ticket in accordance with the Standard Trouble Ticket Submission Process)</i> Will, after sending your organisation an Accepted Notification, classify the Trouble Ticket as a Performance Incident Trouble Ticket or Service Fault Trouble Ticket in accordance with the recommendations of the Service Health Summary Information and notify your organisation accordingly.</p>
<p>nbn... <i>(Only PI Product Element is affected)</i></p>	<ul style="list-style-type: none"> • <i>(If your organisation has raised a Trouble Ticket in accordance with the Trouble Ticket Dispute Process and nbn agrees with your organisation’s dispute)</i> Will, after sending your organisation an Accepted Notification, notify your organisation that nbn agrees with the type of Trouble Ticket your organisation has submitted. • <i>(If your organisation has raised a Trouble Ticket in accordance with the Trouble Ticket Dispute Process and nbn either disagrees with your organisation’s dispute or considers that your organisation has not provided sufficient details as to why it disputes the Service Health Summary Information)</i> Will, after sending your organisation an Accepted Notification: <ul style="list-style-type: none"> • <i>(If the Service Health Summary Information indicates a likely Service Fault)</i> Classify the Trouble Ticket as a Service Fault Trouble Ticket and notify your organisation accordingly;

Who	Activities
	<ul style="list-style-type: none"> • (If the Service Health Summary Information indicates a likely Performance Incident) Classify the Trouble Ticket as a Performance Incident Trouble Ticket and notify your organisation accordingly; or • (If the Service Health Summary Information indicates that the Ordered Product is not subject to either a Service Fault or a Performance Incident) Send your organisation a Rejected Notification and update the Trouble Ticket Status to Rejected and may charge your organisation a No Fault Found Charge, as specified in the nbn® Ethernet Price List.
nbn...	<p>(If the Trouble Ticket was submitted correctly) Evaluates the information provided in the Trouble Ticket and determines whether or not a Trouble Ticket Appointment and/or more information is required to proceed. See the nbn® Ethernet Service Levels Schedule for the timeframe applicable to nbn's performance of this activity.</p> <ul style="list-style-type: none"> • (If nbn determines that the Trouble Ticket contains all information required for the submission of a Trouble Ticket as set out in the Business Rules and a Trouble Ticket Appointment is reserved or a Target Commitment Date is allocated where required) Sends your organisation an Accepted Notification and updates the Trouble Ticket Status to In Progress. • (If nbn determines that more information and/or your organisation's assistance is required to rectify the Service Fault or Performance Incident) Sends your organisation a More Information Required Notification and/or a request for clarification from your organisation, and updates the Trouble Ticket Status first to In Progress, then to In Progress – Pending. • (If nbn determines that a Trouble Ticket Appointment is required) Does either of the following: <ul style="list-style-type: none"> • Confirms that the relevant Trouble Ticket Appointment is associated with the Trouble Ticket, in which case, nbn updates the Trouble Ticket Status to In Progress. • If no Trouble Ticket Appointment has been Reserved and associated with the Trouble Ticket, nbn may ask your organisation to reserve a Trouble Ticket Appointment through the nbn® Service Portal, in which case, nbn updates the Trouble Ticket Status first to In Progress, then to In Progress – Pending. • (If nbn determines that a Trouble Ticket Appointment is not required or your organisation has reserved a Trouble Ticket Appointment otherwise than in accordance with the requirements set out in this WBA Operations Manual) Cancels any Trouble Ticket Appointment. <div style="background-color: #ffffcc; padding: 10px; margin-top: 10px;"> <p> Important: If nbn cannot gain access to a Premises to which a Service Fault or Performance Incident relates, due to an Appointment Representative not being in attendance at the scheduled Trouble Ticket Appointment time, nbn may charge your organisation a Missed Appointment Charge (as specified in the nbn® Ethernet Price List).</p> </div>
nbn... (Only PI Product Element is affected)	<p>(If your organisation has raised a Trouble Ticket in accordance with the Alternative Trouble Ticket Submission Process) Will, after sending your organisation an Accepted Notification:</p> <ul style="list-style-type: none"> • (If nbn considers the Ordered Product is subject to a Service Fault or Performance Incident) Classify the Trouble Ticket as a Service Fault Trouble Ticket or Performance Incident Trouble Ticket (respectively) and notify your organisation accordingly; or • (If nbn considers that the Ordered Product is not subject to either a Service Fault or a Performance Incident) Send your organisation a Rejected Notification and updates the Trouble Ticket Status to Rejected and may charge your organisation a No Fault Found Charge, as specified in the nbn® Ethernet Price List.
nbn ...	<p>(If nbn determines at a later stage that nbn requires your organisation to provide more information and/or assistance, or to reserve an Appointment, to rectify the Service Fault or Performance Incident) Sends your organisation a More Information Required Notification and/or a request for clarification from your organisation, and updates the Trouble Ticket Status first to In Progress – Pending.</p>
Your organisation...	<p>(If nbn sends your organisation a More Information Required Notification or requests that your organisation provide assistance to rectify the Service Fault or Performance Incident at</p>

Who	Activities
	<p>any time): Must as soon as practicable and, in any event, within 2 Business Days of the date that nbn sends the More Information Required Notification or request for assistance:</p> <ul style="list-style-type: none"> gather and provide the requested information or provide the requested assistance; and update the related Trouble Ticket via the nbn[®] Service Portal or B2B Access (as applicable).
nbn...	<p>(If your organisation does not provide the requested information or provide the requested assistance as soon as practicable and, in any event, within 2 Business Days of receiving a More Information Required Notification or request for assistance, as applicable) May update the Trouble Ticket Status of the Trouble Ticket to Resolved and then immediately to Closed in which case nbn will send your organisation a Closed Notification.</p>
nbn... (Only PI Product Element is affected)	<p>(If your organisation has raised a Performance Incident Trouble Ticket in relation to an nbn[®] Ethernet (Fibre) or nbn[®] Ethernet (HFC) Ordered Product and after investigating the Performance Incident Trouble Ticket, nbn determines that the Ordered Product is no longer subject to a Performance Incident) Updates the Trouble Ticket status to In Progress – Monitoring and reviews the performance of the Ordered Product in accordance with section 5.2.13.1 Interactions: The Monitoring Period.</p>
nbn...	<p>Performs the relevant rectification activities to resolve the Service Fault or Performance Incident, and depending on the outcome of those activities, does one of the following:</p> <ul style="list-style-type: none"> (If the Service Fault or Performance Incident cannot be resolved at this stage) Updates the Trouble Ticket Status to In Progress and continues to investigate the Service Fault or Performance Incident until it is resolved, including determining if a Trouble Ticket Appointment is required. (If nbn designates that a Network Activity or Interference Mitigation is required in accordance with section 5.2.8 Network Activity or section 5.2.9.1 Commencing Interference Mitigation (respectively)) Updates the Trouble Ticket Status to In Progress – Held. (If the Service Fault is not a Monitored Enhanced Fault and can be resolved and then is resolved) Resolves and closes the Trouble Ticket in accordance with section 5.2.13.2 Interactions: Closure of a Resolved Trouble Ticket. (If the Monitored Enhanced Fault or Performance Incident can be resolved and then is resolved) Updates the Trouble Ticket status to In Progress – Monitoring and reviews the performance of the Ordered Product in accordance with section 5.2.13.1 Interactions: The Monitoring Period. <div style="background-color: #fff9c4; padding: 10px; margin-top: 10px;"> <p> Important: The processes applicable to Monitored Enhanced Faults will only apply on and from the date nbn notifies your organisation that such functionality has been introduced in accordance with the nbn[®] Ethernet Product Description.</p> </div>
nbn... (Only PI Product Element is affected)	<p>(If a Performance Incident Trouble Ticket has been raised in respect of an Ordered Product, and nbn has subsequently accepted a Service Fault Trouble Ticket in respect of that Ordered Product):</p> <ul style="list-style-type: none"> Updates the Trouble Ticket Status of the Performance Incident Trouble Ticket to In Progress – Held. Manages the Service Fault Trouble Ticket in accordance with the Service Fault rectification processes set out in this Module. (If the Service Fault can be resolved and then is resolved): <ul style="list-style-type: none"> Resolves and closes the Service Fault Trouble Ticket in accordance with section 5.2.13.2 Interactions: Closure of a Resolved Trouble Ticket. (If the Trouble Ticket Status of the Performance Incident Trouble Ticket was In Progress – Monitoring immediately prior to nbn accepting the Service Fault Trouble Ticket) Changes the Trouble Ticket Status of the Performance Incident Trouble Ticket to In Progress – Monitoring and reviews the performance of the Ordered Product in accordance with section 5.2.13.1 Interactions: The Monitoring Period. (If the Trouble Ticket Status of the Performance Incident Trouble Ticket was In Progress immediately prior to nbn accepting the Service Fault Trouble Ticket) Changes the Trouble Ticket Status of the Performance Incident Trouble Ticket to In



Who	Activities
	Progress and manages the Performance Incident Trouble Ticket in accordance with the Performance Incident rectification processes set out in this Module

5.2.4 Priority Assistance Trouble Tickets

See the [nbn® Ethernet Product Description](#), [nbn® Ethernet Service Levels Schedule](#) and [nbn® Ethernet Product Terms](#) for information on Priority Assistance Faults and Priority Assistance Incidents.

! **Important:** Your organisation must have satisfied **nbn** that your organisation supplies Downstream Priority Assistance Services, prior to being able to raise Trouble Tickets for Priority Assistance Faults or Priority Assistance Incidents.

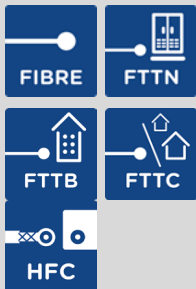
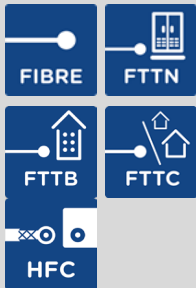
If your organisation wishes to raise Trouble Tickets for Priority Assistance Faults or Priority Assistance Incidents, then it must do so in accordance with the following table:

Technology	Region	Enhanced Fault Rectification Service Level	PA Option Available for Trouble Tickets
	Urban, Minor Rural, Major Rural, Remote	N	Y
		Y	N
	Isolated	N	Y
	All Regions	N	N
All Technologies	Limited Access	N	N

! **Important:** Your organisation will be provided a cautionary message in the **nbn**® Service Portal, at the time that it raises a Trouble Ticket for a Priority Assistance Fault or Priority Fault Incident, confirming that your organisation must have the required supporting documentation from the relevant Contracted End User.

5.2.5 Battery Alarm Processes



This section applies to **nbn**[®] Ethernet (Fibre).

When an NTD powered by a Power Supply with Battery Backup generates a Battery Missing Alarm or a Replace Battery Alarm, and your organisation has elected to receive the Battery Backup Service in respect of a UNI on that NTD, the following processes will be triggered:

Exception: nbn may not provide a Battery Missing Alarm or Replace Battery Alarm notification within the periods set out below if the alarm is generated before, or at the time of, the Activation of an Access Component and no products or services are being supplied on the NTD at the time of the Activation.

Battery Missing Alarm

Who	Activities
nbn...	Will raise a Trouble Ticket for the alarm as soon as practicable, and within 26 hours, after receiving the alarm. Note: This includes a 2 hour delay to allow the Contracted End User to replace the battery.
Your organisation...	Must notify the Contracted End User of the Battery Missing Alarm.
nbn...	<i>(Where Battery Missing Alarm cleared or your organisation selects not to receive the Battery Backup Service)</i> nbn will close the Trouble Ticket.
nbn ...	<i>(Where Battery Missing Alarm not cleared and your organisation continues to receive the Battery Backup Service)</i> <ul style="list-style-type: none"> nbn will send a reminder until Battery Missing Alarm is cleared or the Auto-Closure Rules are met When Battery Missing Alarm has been cleared or the Auto-Closure Rules are met, nbn will close the Trouble Ticket.



Important: The NTD generates a Battery Missing Alarm immediately when a battery is disconnected from the Power Supply with Battery Backup.

If the NTD stops generating the Battery Missing Alarm within 2 hours, **nbn** will not raise any Trouble Ticket.

The Battery Missing Alarm ceases when a battery is detected and the terminals are connected.

Battery Replacement Alarm

Who	Activities
nbn...	Will raise a Trouble Ticket for the alarm as soon as practicable, and within 24 hours, after receiving the alarm.
Your organisation...	Must notify the Contracted End User of the Replace Battery Alarm.
nbn...	<i>(Where Replace Battery Alarm cleared)</i> nbn will stop sending reminders.
nbn ...	<i>(Where your organisation selects not to receive the Battery Backup Service)</i> nbn will stop sending reminders and close the Trouble Ticket.

Who	Activities
nbn ...	<p>(Where your organisation continues to receive the Battery Backup Service)</p> <ul style="list-style-type: none"> nbn will send a reminder until Replace Battery Alarm is cleared or the Auto-Closure Rules are met. When the Auto-Closure Rules are met, nbn will close Trouble Ticket.



Important: nbn will only test battery capacity using a 55 day testing cycle and a Replace Battery Alarm will only be generated by the NTD and Power Supply with Battery Backup once during that testing cycle.

Note: If the battery is disconnected / removed, the Replace Battery Alarm will cease and the NTD will generate the Battery Missing Alarm.

If mains power has failed for longer than the battery can provide power to the NTD, the Replace Battery Alarm will cease and no other alarm will be generated until power is restored to the NTD.



Note: Information for End Users regarding battery-related alarms is described in the *nbn® End User Guide* provided by nbn to the End User at the time of Installation.

5.2.5.1 Battery Alarm Trouble Ticket Status: Descriptions



This section applies to nbn® Ethernet (Fibre).

Each Trouble Ticket which relates to a Battery Missing Alarm or a Replace Battery Alarm will have a Trouble Ticket Status, as indicated by its current status message. The following table provides a high level explanation of each Trouble Ticket Status for a Battery Missing Alarm or a Replace Battery Alarm:

Status	Description
Resolved	Trouble Ticket is raised by nbn reflecting a Battery Missing Alarm or Replace Battery Alarm generated by the NTD and Power Supply with Battery Backup, as relevant.
Closed	<p>One of the following circumstances has arisen:</p> <ul style="list-style-type: none"> Your organisation places a Modify Order for the associated AVC to remove the Battery Backup Service In the case of a Battery Missing Alarm: <ul style="list-style-type: none"> The NTD has ceased generating the Battery Missing Alarm; or nbn has provided your organisation with all reminders required by the Auto-Closure Rules. In the case of a Replace Battery Alarm, the Auto-Closure Rules have been met (note that the NTD may have ceased generating the Replace Battery Alarm and nbn may have ceased providing reminders before this time).



Important: nbn will only test battery capacity using a 55 day testing cycle. If a battery is removed and re installed or replaced, nbn will cease reminding your organisation of the Replace Battery Alarm. However if the re-installed or new battery also requires replacement, nbn will not provide a new Replace Battery Alarm notification until the next 55 day testing cycle.

5.2.6 External Faults

If **nbn** determines that a reported fault or incident is an External Fault, **nbn** will update the relevant Trouble Ticket (via the **nbn**[®] Service Portal or B2B Access, as applicable) as soon as reasonably practicable, as follows:

Attendance	nbn action
nbn [®] Personnel have not attended the location associated with the fault or incident	<p>nbn will update the Trouble Ticket Status of the Trouble Ticket to Resolved, and send your organisation a Resolved Notification via the nbn[®] Service Portal and/or B2B Access. The Resolved Notification will provide a resolution code and a description reflecting there was no fault found and where relevant, associated comments to provide further information that may assist your organisation to understand the outcome of nbn's Trouble Ticket investigation.</p> <ul style="list-style-type: none"> nbn may charge your organisation the No Fault Found (No Truck Roll Required) Charges, as specified in the nbn[®] Ethernet Price List.
nbn [®] Personnel have attended the location associated with the fault or incident	<ul style="list-style-type: none"> nbn will update the Trouble Ticket Status of the Trouble Ticket to Resolved, and send your organisation a Resolved Notification via the nbn[®] Service Portal and/or B2B Access. The Resolved Notification will provide a resolution code and a description reflecting there was no fault found and where relevant, associated comments to provide further information that may assist your organisation to understand the outcome of nbn's Trouble Ticket investigation nbn may charge your organisation the No Fault Found (Truck Roll Required) Charges, as specified in the nbn[®] Ethernet Price List.



An **nbn**[®] Ethernet (HFC) Ordered Product supplied to a Premises will experience a temporary service interruption during the installation, activation, relocation (and any activities reasonably incidental to the installation, activation and relocation) of other services (including another Ordered Product or another Carriage Service or Content Service supplied by your organisation or any third party) using the same PCD or HFC Lead-in Cable as the existing Ordered Product (as set out in section 13.7 of the [nbn](#)[®] Ethernet Product Description).



An **nbn**[®] Ethernet (FTTC) Ordered Product supplied to a Premises will experience a temporary service interruption during the installation, activation, relocation (and any activities reasonably incidental to the installation, activation and relocation) of other services (including another Ordered Product or another Carriage Service or Content Service supplied by your organisation or any third party) using the same **nbn**[®] DPU as the existing Ordered Product (as set out in section 13.8 of the [nbn](#)[®] Ethernet Product Description).

Disputing the Resolution

When the Trouble Ticket is Resolved in circumstances where **nbn** has determined that the reported fault or incident is an External Fault, your organisation may dispute the assigned resolution code through an RSP Enquiry within 2 Business Days of receiving the Resolved Notification. If your organisation disputes an assigned resolution code, **nbn** will review its determination and amend the resolution code if it determines that it is necessary before the Trouble Ticket is Closed.

If your organisation wishes to dispute a resolution code after the Trouble Ticket has been assigned a Trouble Ticket Status of 'Closed', your organisation must contact its **nbn**[®] Operational Point of Contact. **nbn** will then arrange a review of the Trouble Ticket resolution.

See section [5.2.13.2 Interactions: Closure of a Resolved Trouble Ticket](#) for details of the process of closing a Resolved Trouble Ticket in other circumstances.

Professional Wiring Service



This section applies to **nbn**® Ethernet (FTTB), **nbn**® Ethernet (FTTN) or **nbn**® Ethernet (FTTC).

Where **nbn** attends the location associated with the fault and determines that a reported fault or incident is an External Fault, and your organisation has consented to **nbn** performing a Professional Wiring Service, **nbn** may:

- At the time of attending the location associated with the fault or incident, perform a Professional Wiring Service at the End User’s Premises; and
- Charge your organisation the relevant No Fault Found (Truck Roll Required and Professional Wiring Service) Charges, as specified in the [nbn® Ethernet Price List](#).

Faults related to In-building Wiring



This section applies to **nbn**® Ethernet (FTTB), **nbn**® Ethernet (FTTN) or **nbn**® Ethernet (FTTC).

For faults or incidents relating to **nbn**® Ethernet (FTTB), **nbn**® Ethernet (FTTC) or **nbn**® Ethernet (FTTN) Ordered Products that are due to issues with In-building Wiring, these are always External Faults.

Faults related to Unregistered Modems



This section applies to **nbn**® Ethernet (FTTB) or **nbn**® Ethernet (FTTN).

nbn’s response to a Trouble Ticket will differ, depending on whether the Modem being used in connection with the relevant Ordered Product is a Registered Modem , as set out in the table below.

Modem in use	Trouble Ticket Type	
	Performance related (Line Rate, line stability)	Connectivity or no sync incident
Registered Modem	<ul style="list-style-type: none"> • nbn will investigate the fault or incident associated with that Ordered Product. • nbn will perform any required rectification activities if it is a Service Fault or Performance Incident. 	<ul style="list-style-type: none"> • nbn will investigate the fault or incident associated with that Ordered Product. • nbn will perform any required rectification activities if it is a Service Fault or Performance Incident.
Unregistered Modem	<ul style="list-style-type: none"> • nbn will perform a basic investigation to identify whether the cause of the performance issue is within the nbn® Network Boundaries. • If, as a result of the basic investigation, nbn determines that the cause of the performance issue is within the nbn® Network Boundaries, then nbn will further investigate the fault or incident associated with that Ordered Product. If it is a Service Fault or Performance Incident, nbn will perform any required rectification activities. If there is no Service Fault or Performance Incident identified, nbn will update the Trouble 	<ul style="list-style-type: none"> • nbn will investigate the fault or incident associated with that Ordered Product. • nbn will perform any required rectification activities if it is a Service Fault or Performance Incident. • If there is no Service Fault or Performance Incident identified and sync and connectivity can be established, nbn will update the Trouble Ticket Status of the Trouble Ticket to Resolved, and send your organisation a Resolved Notification via the nbn® Service Portal and/or B2B Access. The Resolved Notification

Modem in use	Trouble Ticket Type	
	Performance related (Line Rate, line stability)	Connectivity or no sync incident
	<p>Ticket Status of the Trouble Ticket to Resolved, and send your organisation a Resolved Notification via the nbn[®] Service Portal and/or B2B Access. The Resolved Notification will provide a resolution code and a description reflecting there was no fault found and where relevant, associated comments to provide further information that may assist your organisation to understand the outcome of nbn's Trouble Ticket investigation.</p> <ul style="list-style-type: none"> If, as a result of the basic investigation, nbn determines that the cause of the performance issue is outside of the nbn[®] Network Boundaries, then nbn will not perform any further investigation or rectification activities and nbn will update the Trouble Ticket Status of the Trouble Ticket to Resolved, and send your organisation a Resolved Notification via the nbn[®] Service Portal and/or B2B Access. The Resolved Notification will provide a resolution code and a description reflecting there was no fault found and where relevant, associated comments to provide further information that may assist your organisation to understand the outcome of nbn's Trouble Ticket investigation. nbn may charge your organisation the No Fault Found Charges, as specified in the nbn[®] Ethernet Price List. 	<p>will provide a resolution code and a description reflecting there was no fault found and where relevant, associated comments to provide further information that may assist your organisation to understand the outcome of nbn's Trouble Ticket investigation.</p> <ul style="list-style-type: none"> nbn may charge your organisation the No Fault Found Charges, as specified in the nbn[®] Ethernet Price List.

For more details on how to register a Modem with **nbn**, and **nbn**'s rights in respect of specific Modems (including any model or firmware version) that **nbn** reasonably considers is causing or likely to cause detriment to other services, refer to section [5.3.3 Modem Registration](#).

5.2.7 Resolving Service Faults and Performance Incidents

The [nbn[®] Ethernet Service Levels Schedule](#) governs the Service Levels, Performance Objectives and Operational Targets that apply from the time **nbn** provides your organisation with an Accepted Notification in respect of a Service Fault Trouble Ticket or a Performance Incident Trouble Ticket.

5.2.7.1 Fault Rectification for Priority Assistance Faults or Priority Assistance Incidents

As soon as reasonably practicable after **nbn** has Acknowledged a Trouble Ticket raised by your organisation as a Priority Assistance Fault or Priority Assistance Incident, **nbn** will notify your organisation if either of the following circumstances arise:

- nbn** determines that a reported fault or incident is not a Priority Assistance Fault or Priority Assistance Incident
- nbn** expects that it will not be able to comply with the Service Levels for the Priority Assistance Fault or Priority Assistance Incident.



Important: For **nbn**[®] Ethernet (FTTB) or **nbn**[®] Ethernet (FTTN) see section [6.8.1 Trouble Ticket – Fault Location](#).

5.2.7.2 Fault and incident investigation

If your organisation has raised a Trouble Ticket subject to certain exceptions relating to Unregistered Modems see section [5.3.3.2 Supply of Unregistered Quality-Controlled Modems](#), **nbn** will perform testing and investigation to determine whether it is:

- a Service Fault;
- a Performance Incident; or
- a fault related to any associated Network Fault.

nbn may require a Trouble Ticket Appointment to access the relevant Premises to perform testing, investigation, Service Fault or Performance Incident rectification activities (as applicable).

The following table shows examples of root causes and actions that **nbn** may take as a result of the investigation:

Root Cause	nbn Action
Fault outside nbn[®] Network Boundaries	<p>If after troubleshooting nbn identifies the fault is outside nbn[®] Network Boundaries, nbn will update the Trouble Ticket Status of the Trouble Ticket to Resolved, and send your organisation a Resolved Notification via the nbn[®] Service Portal and/or B2B Access. The Resolved Notification will provide a resolution code and a description reflecting there was no fault found and where relevant, associated comments to provide further information that may assist your organisation to understand the outcome of nbn's Trouble Ticket investigation in accordance with section 5.2.6 External Faults and may charge your organisation in accordance with section 5.2.6 External Faults.</p>
Service Fault rectification	<p>If after troubleshooting nbn identifies a Service Fault, nbn may perform rectification activities which may include:</p> <ul style="list-style-type: none"> • Adjusting the profile of the service between Standard Profile, Stable Profile or Repair Profile • Changing the service to use a different nbn[®] Copper Pair or associate it with a different Internal Copper Pair (as the case may be) • Changing the service to a different nbn[®] Node port • Changing the Jumper Cable or Pillar Jumper Cable • Replacing the Lead-In Cable • An Internal Copper Pair or nbn[®] Copper Pair swap • Replacing nbn[®] Equipment • Installing Voiceband Continuity, where Voiceband Continuity was validly requested in the Product Order Form and nbn failed to install Voiceband Continuity. • Conducting In-Premises Wiring Activities • Realigning or replacing an amplifier in the HFC Network • Replacing a transmitter in the HFC Network <p>nbn will remove or replace a Central Splitter if, and to the extent that, the Service Fault is a Central Splitter Fault (and the definition of Service Fault expressly includes such faults).</p> <p>Note: To the extent permitted by law, nbn will not rectify a fault with a Central Splitter where the:</p> <ul style="list-style-type: none"> • Service Fault is not a Central Splitter Fault; and/or • Service Fault is a Central Splitter Fault and the definition of Service Fault does not expressly include such faults.

Root Cause	nbn Action
Performance Incident rectification <i>(PI Product Elements only)</i>	If nbn has accepted a Performance Incident Trouble Ticket, nbn may perform diagnostic, monitoring and rectification activities which may include: <ul style="list-style-type: none"> • Service Fault rectification activities • Long run testing • Reviewing telemetry data • Pattern detection
Network Fault rectification	If after troubleshooting nbn identifies a Network Fault (in accordance with section 5.4 Network Fault Rectification), nbn will perform rectification activities, which include but are not limited to, resolving any nbn ® Node port shortfall and cabling shortfall.



Important: If, after troubleshooting or after Service Fault or Performance Incident rectification activities, **nbn** designates that a Network Activity or Interference Mitigation is required in respect of an Ordered Product, **nbn** will conduct a Network Activity or Interference Mitigation (as applicable) in accordance with section [5.2.8 Network Activity](#) or section [5.2.9.1 Commencing Interference Mitigation](#) (as applicable).

If a Trouble Ticket is raised in relation to the Information Rate of **nbn**® Ethernet (FTTB) or **nbn**® Ethernet (FTTN) and **nbn** identifies that the relevant Ordered Product is performing in accordance with the [nbn](#)® [Ethernet Product Description](#), (including during the Co-existence Period), **nbn** will change the Trouble Ticket Status of the Trouble Ticket to **Resolved**, and send your organisation a Resolved Notification via the **nbn**® Service Portal and/or B2B Access. The Resolved Notification will provide a resolution code and a description reflecting there was no fault found and where relevant, associated comments to provide further information that may assist your organisation to understand the outcome of **nbn**'s Trouble Ticket investigation in accordance with section [5.2.6 External Faults](#).

5.2.7.3 Recurrent End User Faults



If more than 3 End User Faults occur in any 60 day period in respect of the same End User, then as soon as reasonably practicable following a request by your organisation or following the identification of that event by **nbn**, **nbn** will take all steps that are reasonably practicable in the circumstances to address the recurrence of such End User Faults in respect of the relevant End User.

5.2.8 Network Activity

5.2.8.1 Commencing Network Activity

nbn may designate that a Network Activity is required in the following scenarios:

Technology	Network Activity may be designated where...	In response to...
	Your organisation has requested a Network Activity to achieve any CIR Objective applicable to an ordered AVC TC-2 bandwidth profile in accordance with section 4.5.2.2 Product Component Orders: Additional Information , for a Connect Order that has not yet been completed.	The Line Rate at the nbn ® Downstream Network Boundary so that it is capable of achieving the CIR Objective

Technology	Network Activity may be designated where...	In response to...
	<p>A Service Fault Trouble Ticket has been raised in respect of a TC-2 Ordered Product and:</p> <ul style="list-style-type: none"> • nbn has undertaken all of its standard Service Fault rectification activities; or • nbn has determined, acting reasonably, that the standard Service Fault rectification activities would be unlikely to enable the Line Rate at the nbn[®] Downstream Network Boundary at the relevant Premises to achieve any applicable CIR Objective. 	The Line Rate at the nbn [®] Downstream Network Boundary so that it is capable of achieving the CIR Objective
	<p>A Service Fault Trouble Ticket has been raised in respect of a TC-4 Ordered Product and nbn has:</p> <ul style="list-style-type: none"> • undertaken all of its standard Service Fault rectification activities; or • has determined, acting reasonably, that the standard Service Fault rectification activities would be unlikely to enable the Line Rate at the nbn[®] Downstream Network Boundary at the relevant Premises to achieve any applicable PIR Objective 	The Line Rate at the nbn [®] Downstream Network Boundary so that it is capable of achieving the PIR Objective
PI Product Elements	<p>A Performance Incident Trouble Ticket has been raised and nbn has:</p> <ul style="list-style-type: none"> • undertaken all of its standard Performance Incident rectification activities; or • has determined, acting reasonably, that the standard Performance Incident rectification activities are unlikely to rectify the Performance Incident. 	The Performance Incident



Important: Your organisation must not raise a Trouble Ticket in relation to the Line Rate at the UNI used to serve a Premises if your organisation has previously raised a Trouble Ticket in relation to the same issue and **nbn** has designated the relevant Ordered Product or Premises as requiring a Network Activity.

Note: Your organisation has the right to submit a Disconnect Order for the relevant Ordered Product in accordance with clause F9.1 of the [Head Terms](#) and [Module 4: Activations](#) of this [WBA Operations Manual](#).

5.2.8.2 Network Activity for AVC TC-2 Ordered Product Components ordered on Service Class 13 **nbn**[®] Copper Pairs

nbn may reject or cancel any Trouble Ticket submitted by your organisation, or update the Trouble Ticket Status of any such Trouble Ticket to **Resolved**, if each of the following conditions apply:

- the Trouble Ticket relates to the Line Rate affecting an AVC TC-2 Ordered Product Component;
- the relevant AVC TC-2 Ordered Product Component is supplied using an **nbn**[®] Copper Pair that was Service Class 13 at the time the AVC TC-2 Ordered Product Component was ordered;
- **nbn** has notified your organisation that the **nbn**[®] Copper Pair is not capable of supporting the ordered AVC TC-2 bandwidth profile (having determined, acting reasonably, that this was the case before Activation of the order); and
- **nbn** has decided not to designate that a Network Activity is required in respect of the Ordered Product.

5.2.8.3 Network Activity Process

If **nbn** designates that a Network Activity is required in respect of an Ordered Product, the following process will apply:

Who	Activities
nbn ...	Updates the relevant Order Status or Trouble Ticket Status to In Progress – Held .
nbn ...	<i>(If nbn determines that more information and/or your organisation’s assistance is required for a Network Activity)</i> Sends your organisation a More Information Required Notification and/or a request for assistance from your organisation in accordance with section 5.2.3.1 Interactions: Raising a Trouble Ticket with nbn , and updates the Trouble Ticket Status first to In Progress , then to In Progress - Pending .
Your organisation...	<i>(If nbn sends your organisation a More Information Required Notification or requests that your organisation provide assistance)</i> Must, as soon as practicable and, in any event, within 2 Business Days of the date that nbn sends the More Information Required Notification or request for assistance: <ul style="list-style-type: none"> gather and provide the requested information or provide the requested assistance; and updates the related Trouble Ticket or order (as applicable) via the nbn® Service Portal or B2B Access (as applicable).
nbn ...	<i>(If your organisation does not provide the requested information or provide the requested assistance as soon as practicable and, in any event, within 2 Business Days of receiving a More Information Required Notification or request for assistance, as applicable):</i> <ul style="list-style-type: none"> may cancel any related order in accordance with section 4.5.1.6 Order Status Life-cycle; or may update the Trouble Ticket Status of any related Trouble Tickets (if any) to Resolved and then immediately to Closed, in which case nbn will send your organisation a Closed Notification in accordance with section 5.2.3.1 Interactions: Raising a Trouble Ticket with nbn.
nbn ...	<i>(If an Appointment is required)</i> Notifies your organisation that an Appointment is required, requests your organisation to reserve an Appointment and updates the Order Status or Trouble Ticket Status to In Progress – Pending .
Your organisation...	<i>(Where nbn notifies your organisation that an Appointment is required)</i> Reserves an Appointment in accordance with section 6.3.2 New Appointment Process .
nbn ...	<i>(If nbn notifies your organisation that an Appointment is required and your organisation has reserved an Appointment in accordance with section 6.3.2 New Appointment Process)</i> Updates the Order Status or Trouble Ticket Status to In Progress – Held and: <ul style="list-style-type: none"> for a Network Activity relating to a Connect Order, the processes relating to Installation Appointments will apply; and for a Network Activity relating to a Service Fault or Performance Incident, the processes relating to Trouble Ticket Appointments will apply. Arranges for a technician(s) to attend the relevant site to undertake the Network Activity, which may include: <ul style="list-style-type: none"> a Network Activity (Rehabilitation); and/or a Network Activity (COAT). <div style="background-color: #fff9c4; padding: 10px; margin: 10px 0;">  Important: Where nbn conducts a Network Activity (COAT), the process set out in section 4.8 Changes of Access Technology applies </div> Will update your organisation on the progress of the Network Activity, including notifying your organisation of the: <ul style="list-style-type: none"> Initial Network Activity Update, which will specify whether nbn intends to perform a Network Activity (Rehabilitation) or Network Activity (COAT) (See the nbn® Ethernet Service Levels Schedule for details of the Performance Objectives that apply to this update); Estimated Network Activity Date (See the nbn® Ethernet Service Levels Schedule for details of the Performance Objectives that apply to this update); and Planned Network Activity Date (within a reasonable period before completing Network Activity works). <i>(Where nbn is performing a Network Activity in relation to an ordered product that is supplied either to your organisation or an Other RSP), nbn may:</i>

Who	Activities
	<ul style="list-style-type: none"> notify your organisation of any relevant Ordered Products which may be impacted by the Network Activity; and indicate where any relevant Trouble Tickets raised by your organisation may be impacted by the Network Activity.
nbn ...	<p>(For a Network Activity (Rehabilitation), if nbn finishes the Network Activity (Rehabilitation) works, and considers that no further Network Activity is required):</p> <ul style="list-style-type: none"> (If the Network Activity was triggered by a Connect Order that has not yet been completed) Updates the Order Status to In Progress and completes the order in accordance with section 4.5.2 Connect Orders. (If the Network Activity was triggered by a Trouble Ticket) Updates the Trouble Ticket Status to In Progress – Monitoring and reviews the performance of the Ordered Product in accordance with section 5.2.13.1 Interactions: The Monitoring Period. <div style="background-color: #fff9c4; padding: 10px; border: 1px solid #ccc;"> <p>! Important: If a Service Fault Trouble Ticket is placed in In Progress – Monitoring in accordance with this section 5.2.8.3 Network Activity Process and there is a Performance Incident Trouble Ticket open in connection with the same Ordered Product:</p> <ul style="list-style-type: none"> the Performance Incident Trouble Ticket will remain in In Progress – Held while the Service Fault Trouble Ticket is in In Progress – Monitoring; and once the Service Fault Trouble Ticket is resolved and closed, nbn will update the Trouble Ticket Status of the Performance Incident Trouble Ticket to In Progress – Monitoring and continue to review the performance of the Ordered Product in accordance with section 5.2.13.1 Interactions: The Monitoring Period. </div>
nbn ...	<p>(For a Network Activity (COAT), once nbn finishes the Network Activity (COAT) works):</p> <ul style="list-style-type: none"> follows the process in accordance with section 4.8 Changes of Access Technology; and updates the Trouble Ticket Status to Resolved and then immediately to Closed in accordance with section 5.2.3.1 Interactions: Raising a Trouble Ticket with nbn.

5.2.9 Interference Mitigation



This section applies for **nbn**® Ethernet (FTTB), **nbn**® Ethernet (FTTN) or **nbn**® Ethernet (FTTC).

If **nbn** is required to undertake Interference Mitigation under this Agreement, **nbn** will do so in accordance with:

- (If the relevant Interference Event is caused by **nbn** or a third party that is a Carrier or a carriage service provider) section 5.2.9.1 Commencing Interference Mitigation and any relevant provisions of any applicable Industry Code which has been registered by the ACMA
- (If the relevant Interference Event is not caused by **nbn** or a third party that is a Carrier or a carriage service provider) the whole of this section 5.2.9 Interference Mitigation.

5.2.9.1 Commencing Interference Mitigation

nbn will designate an **nbn**® Ethernet (FTTB), **nbn**® Ethernet (FTTN) or **nbn**® Ethernet (FTTC) Ordered Product as requiring Interference Mitigation if **nbn** determines that it is necessary, proactively identifies that the Ordered Product is experiencing an Interference Event, or all of the following circumstances have been met:

- Your organisation raises a Trouble Ticket for that Ordered Product

- **nbn** has undertaken all of its standard Service Fault or Performance Incident rectification activities (as applicable)
- **nbn** determines that that Ordered Product is still experiencing an Interference Event.

If **nbn** designates that Interference Mitigation is required in respect of the Ordered Product, **nbn** may subsequently designate that the Ordered Product (or the Premises related to the Ordered Product) may instead require a Network Activity, rather than Interference Mitigation.



Important: Your organisation must not raise a Trouble Ticket for an Interference Event in relation to an Ordered Product, if **nbn** has designated that the Ordered Product requires Interference Mitigation.

Note: Your organisation has the right to submit a Disconnect Order for the relevant Ordered Product in accordance with clause F9.1 of the [Head Terms](#) and [Module 4: Activations](#) of this [WBA Operations Manual](#).

5.2.9.2 Interference Mitigation Phase 1

Who	Activities
nbn ...	Designates that Interference Mitigation is required in respect of an nbn [®] Ethernet Ordered Product and updates the relevant Trouble Ticket Status to In Progress - Held .
nbn ...	<i>(If nbn determines that more information and/or your organisation's assistance is required for Interference Mitigation during Interference Mitigation Phase 1 under section 5.2.9.2 Interference Mitigation Phase 1 or Phase 2 under section 5.2.9.3 Interference Mitigation Phase 2)</i> Sends your organisation a More Information Required Notification and/or a request for assistance from your organisation in accordance with section 5.2.3.1 Interactions: Raising a Trouble Ticket with nbn , and updates the Trouble Ticket Status first to In Progress , then to In Progress - Pending .
Your organisation ...	<i>(If nbn sends your organisation a More Information Required Notification or requests that your organisation provide assistance)</i> Must, as soon as practicable and, in any event, within 2 Business Days of the date that nbn sends the More Information Required Notification or request for assistance: <ul style="list-style-type: none"> • gather and provide the requested information or provide the requested assistance; and • updates the related Trouble Ticket or order (as applicable) via the nbn[®] Service Portal or B2B Access (as applicable)
nbn ...	<i>(If your organisation does not provide the requested information or provide the requested assistance as soon as practicable and, in any event, within 2 Business Days of receiving a More Information Required Notification or request for assistance, as applicable)</i> May update the Trouble Ticket Status to Resolved and then immediately to Closed , in which case nbn will send your organisation a Closed Notification in accordance with section 5.2.3.1 Interactions: Raising a Trouble Ticket with nbn .
nbn ...	<i>(If an Appointment is required during Interference Mitigation Phase 1 under section 5.2.9.2 Interference Mitigation Phase 1 or Phase 2 under section 5.2.9.3 Interference Mitigation Phase 2)</i> Notifies your organisation that an Appointment is required, requests your organisation to reserve an Appointment and updates the Trouble Ticket Status to In Progress - Pending .
Your organisation...	<i>(Where nbn notifies your organisation that an Appointment is required)</i> Reserves an Appointment in accordance with section 6.3.2 New Appointment Process .

Who	Activities
nbn ...	<ul style="list-style-type: none"> • (If nbn notifies your organisation that an Appointment is required and your organisation has reserved an Appointment in accordance with section 6.3.2 New Appointment Process) updates the Trouble Ticket Status to In Progress – Held and the processes relating to Trouble Ticket Appointments apply to that Appointment • May arrange for a level 2 field technician to attend the relevant site to undertake the Interference Mitigation activities. Interference Mitigation activities which nbn may perform during Interference Mitigation Phase 1, which will include all necessary activities to verify the fault is due to an Interference Event and to diagnose the cause of the Interference Event. • Performs such other Interference Mitigation activities which can be reasonably performed in a one day ticket of work (as determined by nbn from time to time). • (If nbn, following the completion of such activities, determines that the Interference Event has been resolved) Updates the Trouble Ticket Status to Resolved and then immediately to Closed in accordance with section 5.2.13.2 Interactions: Closure of a Resolved Trouble Ticket. • (If nbn, following the completion of such activities, determines that further Interference Mitigation activities are required) Proceeds with Interference Mitigation Phase 2 and undertakes the relevant steps described in section 5.2.9.3 Interference Mitigation Phase 2.

5.2.9.3 Interference Mitigation Phase 2

Who	Activities
nbn ...	<ul style="list-style-type: none"> • Determines and notifies your organisation either: <ul style="list-style-type: none"> • Interference Mitigation requires an Interference Mitigation Solution in which case nbn will notify your organisation of the applicable Estimated Interference Mitigation Date; or • the relevant Interference Event is beyond nbn's reasonable control, and that nbn will not be able to resolve the relevant Interference Event. • May arrange for the necessary nbn specialist technician(s) to attend the relevant site to assess and implement the Interference Mitigation Solution (if applicable). • (If nbn, following the completion of such activities, determines that the Interference Event has been resolved) Updates the Trouble Ticket Status to Resolved and then immediately to Closed in accordance with section 5.2.13.2 Interactions: Closure of a Resolved Trouble Ticket.

5.2.10 Trouble Ticket Queries

Your organisation may query the Trouble Ticket Status of a Trouble Ticket using the **nbn**[®] Service Portal or B2B Access (as applicable).



Important: Your organisation must always include the Trouble Ticket ID in all communications regarding a Trouble Ticket.

5.2.11 Updating a Trouble Ticket

Each party may use the **nbn**[®] Service Portal or B2B Access to notify the other party of any change to a Service Fault or Performance Incident, by adding information to the related Trouble Ticket's 'Comments' field.

If the change required to a Trouble Ticket is in relation to a Trouble Ticket Appointment, your organisation must follow the processes described in section 6.4.1 [Updating and Rescheduling an Appointment](#).

5.2.12 Requesting a Technical Bridge

Your organisation may request a Technical Bridge as part of a Service Restoration Trouble Ticket investigation.



Important: Your organisation may only request a Technical Bridge for a Service Restoration Trouble Ticket which relates to a Service Fault or a Performance Incident, and not for a Trouble Ticket which relates to a Service Request or a Network Fault.

A Technical Bridge is at **nbn**'s discretion. **nbn** will have regard to matters including the availability of **nbn**'s technical support resources and the severity and urgency of the circumstances relevant to the Service Restoration Trouble Ticket.

Who	Activities
Your organisation...	<ul style="list-style-type: none"> Must have raised a Service Restoration Trouble Ticket, which has a New, Acknowledged, Acknowledged – Pending, In Progress, In Progress – Pending or In Progress – Held status, and have allowed sufficient time after raising the Service Restoration Trouble Ticket or, (if nbn has requested more information) after providing information requested by nbn, for nbn to investigate the circumstances related to the Service Restoration Trouble Ticket before requesting a Technical Bridge. Must make the request for a Technical Bridge via an RSP Enquiry and provide: <ul style="list-style-type: none"> The contact details of the lead technical representative (being a member of your organisation's senior technical support teams); More than one suggested time for the Technical Bridge.
nbn...	<p>Assesses all of the circumstances relevant to the request for a Technical Bridge, and depending on the outcome of this assessment, does one of the following:</p> <ul style="list-style-type: none"> <i>(If the request for a Technical Bridge is accepted by nbn)</i> <ul style="list-style-type: none"> Re-assigns the Service Restoration Trouble Ticket and the request for a Technical Bridge to nbn's tier 2 technical support team. nbn's tier 2 team will engage nbn's tier 3 technical support team as required Updates the Trouble Ticket comments to arrange the relevant details for the Technical Bridge. If your organisation has provided contact details for its lead technical representative, nbn will contact the representative to agree a mutually agreeable time for the Technical Bridge Updates the Service Restoration Trouble Ticket based on the outcomes of the Technical Bridge. <i>(If the request for a Technical Bridge is rejected by nbn)</i> Updates the Trouble Ticket comments to inform your organisation of the outcome of nbn's assessment of the Technical Bridge request.

5.2.13 Resolving and Closing a Trouble Ticket

5.2.13.1 Interactions: The Monitoring Period



Important: This section [5.2.13.1 Interactions: The Monitoring Period](#) does not apply where **nbn** has completed work related to a suspected Service Fault, Performance Incident or Network Activity but has determined that the fault or incident was an External Fault.

The processes applicable to Monitored Enhanced Faults will only apply on and from the date **nbn** notifies your organisation that such functionality has been introduced in accordance with the [nbn® Ethernet Product Description](#).

nbn will update the Trouble Ticket Status of a Trouble Ticket to **In Progress – Monitoring** and review the performance of the Ordered Product over a 7 calendar day period, in the following circumstances.

Trouble Ticket	Circumstances
Service Fault Trouble Ticket	<ul style="list-style-type: none"> • nbn has finished Network Activity (Rehabilitation) works in accordance with section 5.2.8 Network Activity and, upon finishing, does not consider any further Network Activity is required. • nbn has rectified the relevant Monitored Enhanced Fault.
Performance Incident Trouble Ticket	<ul style="list-style-type: none"> • nbn has rectified the relevant Performance Incident • nbn has finished the Network Activity (Rehabilitation) works in accordance with section 5.2.8 Network Activity and, upon finishing, does not consider any further Network Activity is required • The Trouble Ticket Status of a Service Fault Trouble Ticket relating to the same Ordered Product is changed to Closed and the Performance Incident Trouble Ticket was in In Progress - Monitoring prior to that Service Fault Trouble Ticket being raised. • For a Performance Incident Trouble Ticket relating to an nbn[®] Ethernet (Fibre) or nbn[®] Ethernet (HFC) Ordered Product, nbn subsequently identifies that the relevant Ordered Product is performing in accordance with the nbn[®] Ethernet Product Description.

During the Monitoring Period the following processes apply depending on whether **nbn** performed a Network Activity in connection with the Trouble Ticket immediately prior to the Trouble Ticket Status being updated to **In Progress – Monitoring**:

nbn ...	Activities
... does not perform a Network Activity in connection with the Trouble Ticket	<p>Will review the performance of the relevant Ordered Product over the Monitoring Period.</p> <ul style="list-style-type: none"> • (If nbn determines that the Ordered Product is subject to a Service Fault or a Performance Incident during the Monitoring Period) will update the Trouble Ticket Status to In Progress and commence further rectification activities. • (If the Monitoring Period lapses and nbn has not detected a Service Fault or Performance Incident) <ul style="list-style-type: none"> ◦ (for Service Faults that are Monitored Enhanced Faults) will resolve and close the Trouble Ticket in accordance with section 5.2.13.2 Interactions: Closure of a Resolved Trouble Ticket. ◦ (in all other cases) will update the Trouble Ticket Status to Resolved and then immediately to Closed.
... performs a Network Activity in connection with the Trouble Ticket	<p>Will review the performance of the relevant Ordered Product over the Monitoring Period.</p> <ul style="list-style-type: none"> • (If nbn determines that the Ordered Product is subject to a Service Fault or a Performance Incident during the Monitoring Period) will update the Trouble Ticket Status to In Progress - Held and perform any further Network Activity. • (If the Monitoring Period lapses and nbn has not detected a Service Fault or Performance Incident) <ul style="list-style-type: none"> ◦ (for Service Faults that are Monitored Enhanced Faults) will resolve and close the Trouble Ticket in accordance with section 5.2.13.2 Interactions: Closure of a Resolved Trouble Ticket. ◦ (in all other cases) will update the Trouble Ticket Status to Resolved and then immediately to Closed.



Important: nbn will only review the performance of an Ordered Product over the Monitoring Period to the extent that there is a modem at the relevant Premises that is properly connected to be used in connection with the relevant Ordered Product. The Monitoring Period will not be extended on account of any period during which there is not a properly connected modem at the relevant Premises.

5.2.13.2 Interactions: Closure of a Resolved Trouble Ticket

When **nbn** has:

- rectified a Service Fault or Performance Incident;
- completed a Network Activity or Interference Mitigation in connection with a Service Fault or Performance Incident; or
- otherwise Resolved a Trouble Ticket, **nbn** will change the Trouble Ticket Status of the relevant Trouble Ticket to **Resolved**, and send your organisation a Resolved Notification.

nbn will provide a resolution code and a description that describes how the Trouble Ticket was resolved via the **nbn**® Service Portal and/or B2B Access.



Important: The following diagram and table does not apply where **nbn** has updated the Trouble Ticket Status of a Trouble Ticket to **Resolved** and then immediately to **Closed**

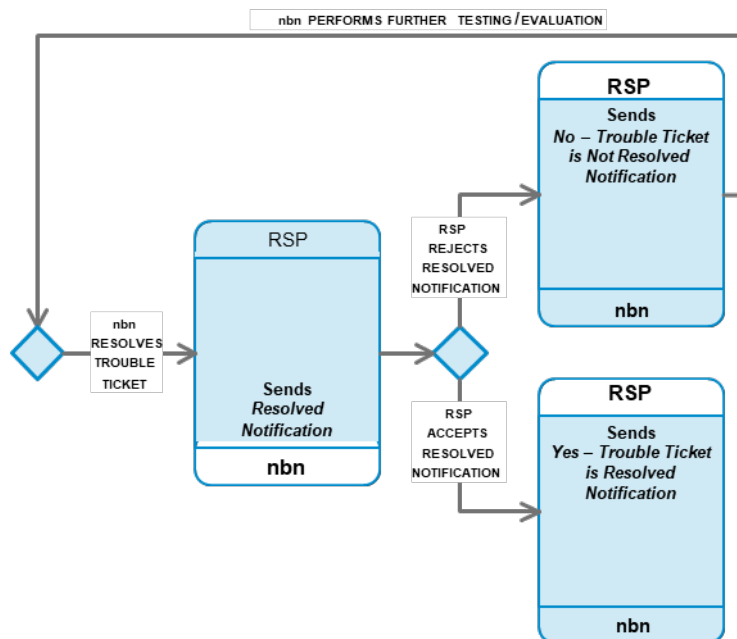

The following diagram illustrates the interactions between your organisation and **nbn** that can arise from **nbn** initiating closure of a Resolved Trouble Ticket.



Description

The following table describes the interactions between your organisation and **nbn** that can arise from **nbn** initiating closure of a Resolved Trouble Ticket.

Who	Activities
nbn ...	Sends a Resolved Notification to your organisation.
Your organisation...	Investigates and verifies whether the Service Fault associated with the Trouble Ticket has been resolved by doing all of the following: <ul style="list-style-type: none"> • Testing the affected Ordered Product

Who	Activities
	<ul style="list-style-type: none"> Testing and/or conducting an investigation to confirm that the Service Fault has been rectified, and no longer impacts your organisation and/or affected Downstream Service Provider(s) or Contracted End User(s). <p>Depending on the results of the testing/investigation, does either of the following within 2 Business Days of receiving the Resolved Notification:</p> <ul style="list-style-type: none"> <i>(If your organisation accepts the Resolved Notification)</i> Submits a “Yes – Trouble Ticket is Resolved Notification” via the nbn[®] Service Portal or B2B Access. nbn will then change the Trouble Ticket Status to Closed and send a Closed Notification to your organisation. <i>(If your organisation disagrees with the Resolved Notification)</i> Submits a “No – Trouble Ticket is Not Resolved Notification” (together with a reason for the disagreement) via the nbn[®] Service Portal or B2B Access. <div style="background-color: #fff9c4; padding: 10px; margin-top: 10px;"> <p> Important: Your organisation must not submit a “No – Trouble Ticket is Not Resolved Notification” if the issue relates to the Line Rate or Information Rate (PIR or CIR) at the UNI used to service a Premises and nbn is performing a Network Activity in respect of that Ordered Product</p> </div>
nbn...	<p><i>(After receiving a “No – Trouble Ticket is Not Resolved Notification”)</i> Performs further testing and investigation in relation to the Service Fault (during which time the Trouble Ticket Status will remain Resolved) and:</p> <ul style="list-style-type: none"> <i>(If, within 2 Business Days of nbn sending the Resolved Notification, nbn assesses that the Service Fault has not been resolved)</i> Returns the Trouble Ticket Status to In Progress and continues to investigate the Service Fault. <i>(If, after 2 Business Days of nbn sending the Resolved Notification, nbn has not changed the Trouble Ticket Status to In Progress)</i> Changes the Trouble Ticket Status to Closed and sends a Closed Notification to your organisation. <div style="background-color: #fff9c4; padding: 10px; margin-top: 10px;"> <p> Important: nbn may request additional information from your organisation within 2 Business Days of nbn sending the Resolved Notification to assess whether or not the Service Fault has been resolved.</p> </div>



Important: If **nbn** has completed work related to a suspected Service Fault, Performance Incident or Network Activity, but has determined that the fault or incident was an External Fault, **nbn** may impose Charges for the work, in accordance with the [nbn[®] Ethernet Price List](#).

See section [5.2.6 External Faults](#) for additional information regarding External Faults.

Further Testing After Your Organisation Disagrees with a Resolution Notice

If, after performing further testing and investigation following re-opening the Trouble Ticket within the **nbn**[®] Service Portal or B2B Access (as applicable), and returning the Trouble Ticket’s status to In Progress, **nbn** considers that a Service Fault associated with a Trouble Ticket has been resolved, or a Network Activity has been completed, **nbn** will reissue the Resolved Notification to your organisation through the **nbn**[®] Service Portal or B2B Access (as applicable).

If your organisation disagrees with the reissued Resolved Notification, your organisation may then escalate the Trouble Ticket in accordance with section [5.2.15 Escalating an Unresolved Trouble Ticket](#).

Your organisation may also raise a request for further information relating to a Closed Trouble Ticket with the **nbn**[®] Operational Point of Contact.

5.2.13.3 Your Organisation Requests Closure of a Trouble Ticket

If your organisation considers that it has successfully resolved a Trouble Ticket without intervention by **nbn**, your organisation must use the **nbn**[®] Service Portal or B2B Access (as applicable) to immediately notify **nbn** and request closure of the Trouble Ticket.

Activities

The following table describes the interactions between your organisation and **nbn** that can arise from your organisation requesting closure of a Trouble Ticket.

Who	Activity
Your organisation...	Identifies that the Trouble Ticket is no longer required, and requests (via the nbn [®] Service Portal or B2B Access (as applicable)) that nbn close it.
nbn...	Investigates, tests and/or verifies that the Service Fault or Performance Incident has been properly resolved and does all of the following: <ul style="list-style-type: none"> • Changes the Trouble Ticket Status of the Trouble Ticket to Resolved and sends your organisation a Resolved Notification • Changes the Trouble Ticket Status of the Trouble Ticket to Closed and sends your organisation a Closed Notification.



Important: **nbn** may impose Charges for the work, in accordance with the [nbn[®] Ethernet Price List](#), where the fault is an External Fault.

See section [5.2.6 External Faults](#).

5.2.14 Cancelling a Trouble Ticket

5.2.14.1 **nbn** initiates cancellation

In some cases, **nbn** will **Cancel** rather than Close a Trouble Ticket.

Example: **nbn** creates a new Trouble Ticket in error.

nbn will cancel any in-flight trouble tickets raised by an Other Losing RSP upon completion of a Service Transfer Order. A trouble ticket will not be transferred to your organisation (as the Gaining RSP).

5.2.14.2 Your Organisation initiates cancellation

Your organisation can cancel a Trouble Ticket through the **nbn**[®] Service Portal or B2B Access where the Trouble Ticket Status is:

- Acknowledged;
- Acknowledged – Pending;
- In Progress; or
- In Progress – Pending.

Your organisation may cancel a Trouble Ticket in scenarios such as where your organisation has inadvertently raised a duplicate Trouble Ticket. For clarity, cancellation of a Trouble Ticket is distinct from closure of a Trouble Ticket.

If your organisation considers that it has successfully resolved a Trouble Ticket without intervention by **nbn**, your organisation must follow the process to close the Trouble Ticket under section [5.2.13.3 Your Organisation Requests Closure of a Trouble Ticket](#). Your organisation must not cancel the Trouble Ticket under this section [5.2.14.2 Your Organisation initiates cancellation](#).

5.2.14.3 Your Organisation requests cancellation

Your organisation may request that **nbn** cancel a Trouble Ticket by submitting an RSP Enquiry (this applies for any Trouble Ticket Status, including one for which your organisation can alternatively cancel a Trouble Ticket under section [5.2.14.2 Your Organisation initiates cancellation](#)). If **nbn** considers that your organisation has reasonable grounds for requesting the cancellation, **nbn** may cancel the Trouble Ticket.



Important: The RSP Enquiry must include an explanation as to why your organisation wants the Trouble Ticket cancelled.

5.2.15 Escalating an Unresolved Trouble Ticket

If your organisation wishes to escalate a Trouble Ticket where it disagrees with a re-issued Resolved Notification, it must submit a notice (Trouble Ticket Escalation Notice) by one of the following methods:

- To the **nbn**[®] Operational Point of Contact
- By telephoning RSP Support Centre.

nbn will then evaluate the validity of the Trouble Ticket Escalation Notice. If valid, **nbn** will endeavour to perform remedial works to resolve the Service Fault or Performance Incident.

5.2.16 End User Faults and End User Incidents related to a Network Fault

On occasions where your organisation raises a Trouble Ticket for an End User Fault or End User Incident that is related to a Network Fault, **nbn** will link the Trouble Ticket for the End User Fault or End User Incident to the Infrastructure Restoration Trouble Ticket for the Network Fault.

The Service Levels and Performance Objectives that apply to End User Faults or End User Incidents also apply to End User Faults and End User Incidents (respectively) that have been linked in this way and will remain the same as if the linking had not occurred. However, the rectification of the associated Network Fault may result in the End User Fault or End User Incident also being rectified.

5.2.17 Performance Incidents

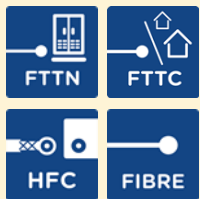







This section applies to **nbn**[®] Ethernet (Fibre), **nbn**[®] Ethernet (FTTN), **nbn**[®] Ethernet (FTTC) and **nbn**[®] Ethernet (HFC)

nbn may make any changes to this section [5.2.17 Performance Incidents](#) in accordance with the process that applies to changes under clause F4.7(a) of the [Head Terms](#).

5.2.17.1 PI Threshold

Subject to section 5.2.17.2 Exclusions, the PI Product Elements and the PI Thresholds that apply for each PI Product Element, are as follows:

PI Product Element	PI Threshold
<p>AVC Product Component</p>   	<p>4 to 7 Unexpected Dropouts within 1 calendar day, occurring in the current day or any of the 2 previous calendar days.</p> <p>Unexpected Dropout means, in respect of an AVC Product Component, a temporary loss of connectivity arising other than in connection with:</p> <ul style="list-style-type: none"> • an Excluded Event or Customer Event; or • an Outage (except where the temporary loss of connectivity is contributed to by an Emergency Outage performed in response to an existing Service Fault or Performance Incident where an End User has reported the failure to your organisation and your organisation has raised a Trouble Ticket in respect of that failure).
<p>AVC TC-4 ordered bandwidth profile being equal to, or greater than, 25 Mbps (PIR) downstream and 5 Mbps (PIR) upstream</p> 	<p>The Observed Average Rate (where available) is equal to or greater than 25 downstream Mbps (PIR) and 5 upstream Mbps (PIR), but less than:</p> <ul style="list-style-type: none"> • the maximum PIR achievable for the relevant AVC TC-4 ordered bandwidth profile; and • 50 downstream Mbps (PIR) and 20 upstream Mbps (PIR).
<p>AVC TC-4 ordered bandwidth profile of greater than 12 Mbps (PIR) downstream and 1 Mbps (PIR) upstream</p> 	<p>The Observed Average Rate (where available) is:</p> <ul style="list-style-type: none"> • equal to or greater than 12 downstream Mbps (PIR) and 1 upstream Mbps (PIR), but less than: <ul style="list-style-type: none"> • (<i>during the Co-existence Period</i>) the Information Rate specified in the most recent relevant Line Rate and Information Rate Report as the "Assured Rate" for that nbn[®] Copper Pair which will be at least equal to: <ul style="list-style-type: none"> • 25 downstream Mbps (PIR) and 5 upstream Mbps (PIR), minus • the impact on the Line Rate (in Mbps), as estimated by nbn, of factors relating to the Co-existence Period; or • (after the Co-existence Period) 25 downstream Mbps (PIR) and 5 upstream Mbps (PIR); or • equal to or greater than 25 downstream Mbps (PIR) and 5 upstream Mbps (PIR), but less than each of the following: <ul style="list-style-type: none"> • the Information Rate specified in the most recent relevant Line Rate and Information Rate Report as the "Assured Rate" for that nbn[®] Copper Pair, which will be at least equal to 80% of the highest Observed Average Rate previously estimated in respect of the relevant AVC TC-4; and • 80% of the maximum PIR achievable for the relevant AVC TC-4 ordered bandwidth profile. <p>Observed Average Rate means, in respect of an AVC TC-4 Ordered Product Component supplied using an nbn[®] Copper Pair, the average downstream and upstream PIR capable of being achieved by that AVC TC-4, as estimated by nbn across at least 7 point in time Line Rate measurements in respect of that nbn[®] Copper Pair.</p>
<p>AVC TC-4 Ordered Product</p>	<p>Both of the following are satisfied:</p>

PI Product Element	PI Threshold						
<p>Component for which the Service Health Summary Tool makes a throughput test available*</p> 	<ul style="list-style-type: none"> the Point in Time Speed for either the downstream or upstream link is consistently below the relevant "Point in Time Speed Threshold", as set out in the table below (based on the downstream PIR of the bandwidth profile of the relevant AVC TC-4); and no underlying network performance issue has been identified as part of nbn's initial triage activities. <table border="1" style="width: 100%; margin-top: 10px;"> <thead> <tr> <th style="background-color: #0070C0; color: white;">Bandwidth profile</th> <th style="background-color: #0070C0; color: white;">Point in Time Speed Threshold</th> </tr> </thead> <tbody> <tr> <td style="text-align: center;">Downstream PIR of 100 Mbps or less</td> <td style="text-align: center;">80% of the PIR</td> </tr> <tr> <td style="text-align: center;">Downstream PIR of more than 100 Mbps</td> <td style="text-align: center;">70% of the PIR</td> </tr> </tbody> </table> <p>Point in Time Speed means, in respect of an nbn[®] Ethernet (Fibre) or nbn[®] Ethernet (HFC) Ordered Product, the maximum downstream and upstream bandwidth throughput capability of that Ordered Product, as measured by nbn using a point-in-time test.</p>	Bandwidth profile	Point in Time Speed Threshold	Downstream PIR of 100 Mbps or less	80% of the PIR	Downstream PIR of more than 100 Mbps	70% of the PIR
Bandwidth profile	Point in Time Speed Threshold						
Downstream PIR of 100 Mbps or less	80% of the PIR						
Downstream PIR of more than 100 Mbps	70% of the PIR						

*** Notes:**

- An ordered AVC TC-4 bandwidth profiles with a downstream PIR of 2Gbps will still constitute a PI Product Element even if the Service Health Summary Tool does not make a throughput test functionality available for that ordered bandwidth profile. Any Performance Incident Trouble Ticket submitted in those circumstances will need to be submitted in accordance with the Trouble Ticket Dispute Process in section [5.2.2 Trouble Tickets](#).
- For an **nbn**[®] Ethernet (Fibre) AVC TC-4 supplied to a F-NTD (version 1):
 - the Service Health Summary Tool may only make a throughput test available in respect of the downstream link, in which case no PI Threshold will apply in respect of the Point in Time Speed of the upstream link; and
 - the Service Health Summary Tool will not make a throughput test available for that AVC TC-4 (including in respect of the downstream link) if ordered products are being supplied to each of the 4 ports on that F-NTD.

5.2.17.2 Exclusions

This section [5.2.17 Performance Incidents](#) does not apply to any incident affecting an Ordered Product:

- supplied with an Enhanced Fault Rectification Service; or
- that is an **nbn**[®] Ethernet (FTTB) Ordered Product, **nbn**[®] Ethernet (Wireless) Ordered Product or **nbn**[®] Ethernet (Satellite) Ordered Product.

5.2.18 Self Replacement - FTTC



This section applies to **nbn**[®] Ethernet (FTTC)

This section applies when your organisation selects the Self Replacement – FTTC option in accordance with the **Test & Diagnostic Checklist** at the time of raising a Service Fault Trouble Ticket. Except where specified otherwise, the processes set out in this section apply in addition to any other applicable processes set out in this document, including section [5.2.3 Raising, Validating and Resolving a Trouble Ticket](#)

The following diagram and table describes the high level interactions between **nbn** and your organisation that may arise where a Self Replacement – FTTC is required.

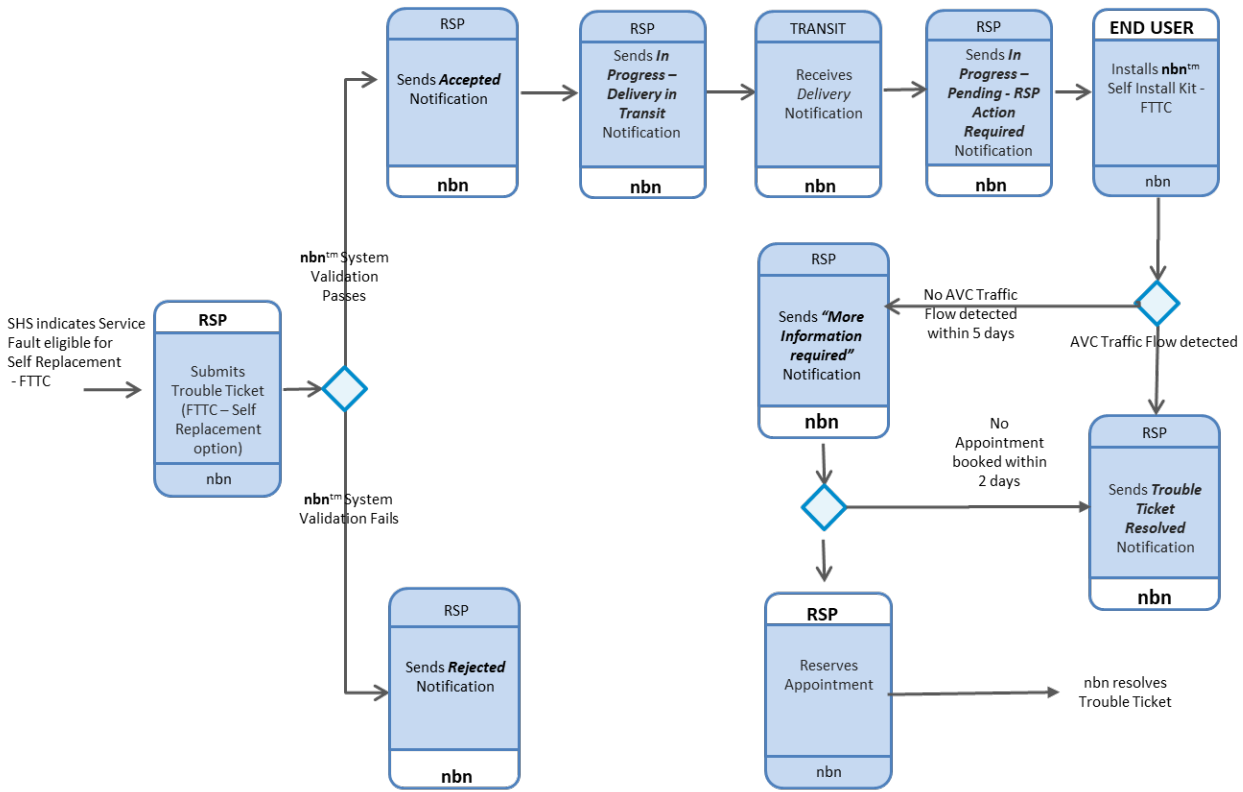

Who	Activity
Your organisation...	<p>(Where the results of the Test & Diagnostic Checklist indicate that the Service Fault is eligible for the Self Replacement – FTTC option) Selects the Self Replacement – FTTC option.</p> <div style="background-color: #FFF2CC; padding: 10px; margin: 10px 0;"> <p>! Important: Before selecting the Self Replacement – FTTC option, your organisation must ensure that the Contracted End User has agreed to return the equipment to be replaced by the Self-Install Kit - FTTC in accordance with the instructions accompanying the new Self-Install Kit - FTTC.</p> </div> <div style="background-color: #FFF2CC; padding: 10px; margin: 10px 0;"> <p>! Important: Your organisation must not associate an Appointment with a Trouble Ticket if your organisation has requested the Self Replacement – FTTC option. nbn will cancel any such Appointment.</p> </div>
nbn...	<ul style="list-style-type: none"> (Once nbn has sent a Trouble Ticket Accepted Notification and updated the Trouble Ticket Status to In Progress) Dispatches the Self-Install Kit – FTTC and any additional accompanying instructions to the Contracted End User’s delivery address. nbn will then update the Trouble Ticket with the in transit date and time and send a delivery in transit notification and shipping tracking identifier. nbn will not undertake any other fault rectification activities during this period in respect of the Trouble Ticket. (When the Self-Install Kit – FTTC is delivered or attempted to be delivered) Updates the Trouble Ticket status to In Progress – Pending.
Your organisation...	<p>(When the Trouble Ticket Status is In Progress – Pending)</p> <ul style="list-style-type: none"> Must ensure that the Contracted End User promptly installs the Self Install Kit - FTTC in accordance with the accompanying installation instructions. If necessary, provides remote assistance to the Contracted End User in relation to the installation of the Self Install Kit - FTTC.

Who	Activity
Your organisation...	<i>(If your organisation cancels the Trouble Ticket in accordance with section 5.2.14.2 Your Organisation initiates cancellation)</i> Must ensure that the Contracted End User posts the unused Self-Install Kit - FTTC to nbn using the return address label in the Self-Install Kit - FTTC.
nbn ...	<i>(If nbn detects AVC Traffic Flow in respect of the nbn[®] Ethernet (FTTC) Ordered Product supplied to the Premises)</i> Updates the Trouble Ticket Status of the Trouble Ticket to Resolved and sends your organisation a Resolved Notification, following which section 5.2.13 Resolving and Closing a Trouble Ticket applies.
nbn ...	<ul style="list-style-type: none"> <i>(If nbn does not detect AVC Traffic Flow in respect of the nbn[®] Ethernet (FTTC) Ordered Product supplied to the Premises within 5 days of the Trouble Ticket Status being updated to In Progress – Pending)</i> Will send your organisation a More Information Required Notification requesting your organisation to reserve an Appointment. <div style="background-color: #fff9c4; padding: 10px; margin: 10px 0;"> <p> Important: If your organisation wants to reserve an Appointment before the end of this 5 day period, you must submit an RSP Enquiry. nbn will then advise your organisation regarding how to proceed.</p> </div> <ul style="list-style-type: none"> <i>(If your organisation has not booked an Appointment within 2 Business Days of the More Information Required Notification)</i> Will update the Trouble Ticket Status of the Trouble Ticket to Resolved and send your organisation a Resolved Notification, following which section 5.2.13 Resolving and Closing a Trouble Ticket will apply.
Your organisation...	<i>(If the Service Fault is rectified without an Appointment)</i> Must ensure that the Contracted End User sends the equipment to be replaced by the Self-Install Kit - FTTC to nbn in accordance with the instructions accompanying the Self-Install Kit – FTTC.

5.3 Service Requests

5.3.1 Raising Service Requests

Your organisation may raise a Service Request including for the following:

- Temporary planned RSP Transaction Quota adjustment request (as per the Service Description for the **nbn**[®] Platform Interfacing Service)
- Temporary unplanned RSP Transaction Manager deactivation request (as per the Service Description for the **nbn**[®] Platform Interfacing Service)
- Modem registration
- For **nbn** to replace a W-NTD version 1 or W-NTD version 2 at a Premises receiving a Wireless Plus Ordered Product

5.3.2 Minimum Modem Quality Standards (MMQS)



This section applies to **nbn**[®] Ethernet (FTTB) and **nbn**[®] Ethernet (FTTN).

nbn will make the Minimum Modem Quality Standards (MMQS) available to your organisation in the Network Interface Specifications.

Except where a change is required by any applicable law or is necessary or desirable as a result of a Regulatory Event, **nbn** will:

- prior to making any change to the MMQS, consult with your organisation and then give at least 12 months' notice of the change to your organisation; and
- not make any change to the MMQS more than once in any 12 month period.

5.3.3 Modem Registration



This section applies to **nbn**® Ethernet (FTTB) and **nbn**® Ethernet (FTTN).

Your organisation may register Modem models and firmware versions to be used with **nbn**® Ethernet (FTTB) and **nbn**® Ethernet (FTTN) – refer to section 33 of the [nbn® Ethernet Product Terms](#).

Your organisation must ensure that each Modem that your organisation intends to register with **nbn** meets the MMQS (including in respect of the specific model and firmware version).

To register a specific Modem model or firmware version with **nbn**, or to update such a registration, your organisation must raise a Service Request through the **nbn**® Service Portal and provide samples of the Modem model with the applicable firmware version, and if requested by **nbn** provide the information and certifications detailed in the MMQS.

Your organisation must ensure that all the information and certifications provided to **nbn** are accurate and up to date.



Important: Your organisation must notify **nbn** of any changes to any Modem hardware or firmware, together with details of any such changes, irrespective of whether the Modem is a Registered Modem and irrespective of whether such change affects the performance of the Modem.

This notice should be provided to **nbn** as soon as reasonably practicable and, in any event, must be provided to **nbn** within 20 Business Days of **nbn** providing a quarterly report to your organisation under section [5.3.4 nbn Support for Modem Performance Optimisation](#) that identifies any change to Modem hardware or firmware that has not previously been notified by your organisation to **nbn**.

5.3.3.1 De-registering Modems

If the hardware or firmware of any Modem is updated in a way that impacts the VDSL components or VDSL drivers, then, except as set out below, the updated Modem will cease to be a Registered Modem and your organisation must re-certify and re-register the new hardware and firmware (as applicable) in accordance with section [5.3.3 Modem Registration](#). Your organisation must re-certify and re-register the new hardware and firmware (as applicable) in these circumstances as soon as reasonably practicable and, in any event, within 10 Business Days of **nbn** notifying your organisation of a relevant hardware or firmware update that **nbn** has identified

The paragraph above does not apply for:

- changes that impact the VDSL drivers only (i.e. do not impact the VDSL components) provided that:
 - your organisation warrants to **nbn** that the Modem continues to meet the MMQS after the change is implemented; and
 - your organisation has informed **nbn** of the relevant changes, including details of any new hardware or firmware; and
- changes to the hardware or firmware of any Modem, such as changes to the Wi-Fi capability or security updates, that do not impact the VDSL components or VDSL drivers.

If **nbn** or your organisation reasonably considers that a Registered Modem may no longer comply with the revised MMQS (as amended in accordance with section [5.3.2 Minimum Modem Quality Standards \(MMQS\)](#)),

nbn or your organisation (as applicable) must notify the other party as soon as reasonably practicable, in which case your organisation must, as soon as reasonably practicable after such notice, and in any event within 3 months of such notice, either:

- do all things necessary to re-register the relevant Modem; or
- cease supplying the relevant Modem and ensure that each Downstream Service Provider ceases to supply that Modem.

If the relevant Modem is not re-registered within 3 months of such notice, that Modem will cease to be a Registered Modem on and from the end of that 3 month period.

For more details on MMQS, refer to the [Network Interface Specification – UNI-DSL](#).



Important: Irrespective of whether a Modem is a Registered Modem, where a specific Modem or a certain model or firmware version of a Modem is causing (or **nbn** reasonably considers that it is causing or likely to cause) detriment to other services, **nbn** may do any one or more of the following:

- Remove the Modem from the Modem registration list
- Place an Ordered Product using that Modem into a Repair Profile
- Suspend an Ordered Product using that Modem in accordance with the [nbn® Ethernet Product Terms](#).

nbn will notify your organisation when removing a Modem from the registration list.

5.3.3.2 Supply of Unregistered Quality-Controlled Modems



Important: This section [5.3.2.2 Supply of Unregistered Quality-Controlled Modems](#) does not apply in respect of Exempt Modems.

The process set out in the table below will apply if **nbn** or your organisation considers that one or more Unregistered Quality-Controlled Modems have, or may have, been supplied to an End User by:

- your organisation on or after the MMQS Date; or
- a Downstream Service Provider, on or after the Downstream MMQS Date:

Who	Activity
nbn or your organisation...	<p><i>(In the case of nbn)</i> May notify your organisation that nbn considers that your organisation or a Downstream Service Provider (as applicable) has, or may have, supplied one or more Unregistered Quality-Controlled Modem; or</p> <p><i>(In the case of your organisation)</i> Must notify nbn that it considers that your organisation or a Downstream Service Provider has, or may have, supplied one or more Unregistered Quality-Controlled Modems.</p>
Your organisation...	Must make reasonable enquiries to determine whether your organisation or a Downstream Service Provider (as applicable) has supplied one or more Unregistered Quality-Controlled Modems.
Your organisation...	<i>(If your organisation determines that your organisation or a Downstream Service Provider (as applicable) has not supplied any Unregistered Quality-Controlled Modems)</i> Must notify nbn accordingly within 10 Business Days, together with details of the enquiries made by your organisation.
Your organisation...	<p><i>(If your organisation determines that one or more Unregistered Quality-Controlled Modems has been supplied by or on behalf of your organisation)</i> Must notify nbn within 10 Business Days of the steps your organisation is proposing to take to (as soon as reasonably practicable):</p> <ul style="list-style-type: none"> • cease supplying any Unregistered Quality-Controlled Modems; • remediate any Unregistered Quality-Controlled Modems that were supplied by or on behalf of your organisation, for example through firmware upgrades, to meet the Minimum Modem Quality Standards;

	<ul style="list-style-type: none"> provide samples of relevant Unregistered Quality-Controlled Modems (including as upgraded with correct firmware) to nbn for further nbn testing; and replace any Unregistered Quality-Controlled Modems that were supplied by or on behalf of your organisation and are unable to be properly remediated. <p>(Remedial Action Plan).</p> <p><i>(If your organisation determines that one or more Unregistered Quality-Controlled Modem has been supplied by or on behalf of a Downstream Service Provider)</i> Must use reasonable endeavours to provide, within 10 Business Days, a Remedial Action Plan to nbn on behalf of the relevant Downstream Service Provider in respect of Unregistered Quality-Controlled Modems supplied by or on behalf of that Downstream Service Provider.</p>
nbn...	<i>(If nbn is not satisfied, acting reasonably, with the Remedial Action Plan)</i> Notifies your organisation within 10 Business Days of the issues that nbn has identified with the Remedial Action Plan, and requires your organisation to provide an updated Remedial Action Plan within 10 Business Days.
nbn ...	<i>(If nbn is not satisfied with the amended Remedial Action Plan)</i> May do either one or both of the following: <ul style="list-style-type: none"> repeat the step above; and by giving your organisation 20 Business Days' notice, impose a Discount Freeze, Ordering Freeze or Suspension in respect of part or all of one or more Ordered Products using the Unregistered Quality-Controlled Modems until such time as nbn is satisfied, acting reasonably, with the Remedial Action Plan.
nbn...	<i>(If nbn is satisfied, acting reasonably, with the Remedial Action Plan, including as amended if applicable)</i> Notifies your organisation within 10 Business Days that it has accepted the Remedial Action Plan, and such notice may also include details of any reporting that nbn may require your organisation to provide in relation to the Remedial Action Plan.
Your organisation...	<i>(Once nbn has accepted a Remedial Action Plan)</i> Must comply with the Remedial Action Plan and, if applicable, use reasonable endeavours to ensure the relevant Downstream Service Provider complies with the Remedial Action Plan (including providing any relevant reporting required by nbn in connection with the Remedial Action Plan).
nbn...	<i>(If nbn considers, acting reasonably, that your organisation or the relevant Downstream Service Provider (as applicable) is not complying with a Remedial Action Plan that has been accepted by nbn)</i> May impose a Discount Freeze, Ordering Freeze, or Suspension in respect of part or all of one or more Ordered Products using Unregistered Quality-Controlled Modems provided that: <ul style="list-style-type: none"> nbn has notified your organisation that it considers, acting reasonably, that your organisation or the relevant Downstream Service Provider (as applicable) is not complying with the Remedial Action Plan, together with details of the alleged non-compliance; and your organisation has failed to satisfy nbn, acting reasonably, that your organisation or the relevant Downstream Service Provider (as applicable) either has been complying with the Remedial Action Plan, or has rectified its non-compliance, within 10 Business Days after receiving notice from nbn.

5.3.3.3 End User-Supplied Modems

nbn may notify your organisation if **nbn** considers that any End User-Supplied Modem is adversely affecting the performance of any **nbn**[®] Ethernet Ordered Product, RSP Product or Downstream Product.

If **nbn** provides your organisation with a notification under this section [5.3.3.3 End User-Supplied Modems](#), your organisation must use reasonable endeavours to inform the relevant Contracted End User, at the next End User Contact Event, that the End User-Supplied Modem is adversely affecting the performance of an **nbn**[®] Ethernet Ordered Product, RSP Product or Downstream Product (as applicable), together with any additional details provided by **nbn** regarding the effect of the End User-Supplied Modem.

5.3.4 nbn Support for Modem Performance Optimisation

5.3.4.1 Reporting

nbn will provide your organisation with quarterly reporting regarding the performance of Modems that are used at scale in connection with **nbn**[®] Ethernet Ordered Products. This reporting will include details of the effect that each Modem has been recorded by **nbn** as having on ordered products in respect of:

- speed;
- stability; and
- any other matters that **nbn** determines from time to time.

5.4 Network Fault Rectification

5.4.1 Infrastructure Restoration Trouble Tickets

When a Network Fault is identified by **nbn** (including where it is identified in response to your organisation raising a Service Request under this section), **nbn** will raise an Infrastructure Restoration Trouble Ticket for affected retail service provider(s) (including your organisation, if applicable).

Your organisation may use the information in an Infrastructure Restoration Trouble Ticket to manage V-NNI RSP, Downstream Service Provider or Contracted End User impacts.



Important: If your organisation submits unnecessary Test & Diagnostic Transactions to the **nbn**[®] Platform Interfacing Service, the transactions may cause your organisation to exceed its Transaction Quota or API Quota for Monitored Transactions and result in the de-prioritisation, delay, limitation or rejection of subsequent Test & Diagnostic Transactions. See the [Service Description for the nbn[®] Platform Interfacing Service](#) for details.

Upon resolution of a Network Fault, **nbn** will provide a detailed description of how the Network Fault was resolved in the Infrastructure Restoration Trouble Ticket.

Your organisation may request, by raising a Service Request, that **nbn** investigate an incident or fault, or series of incidents or faults, that your organisation reasonably considers is impacting multiple Contracted End Users. Prior to raising such a Service Request, your organisation must for the relevant incident(s) or fault(s) do both of the following:

- Conduct all relevant tests and diagnostic tasks in the Test & Diagnostic Checklist; and
- Include details of the results of your organisation's troubleshooting and the contact details of your organisation's lead technical support representative for the incident(s) or fault(s) in the Service Request comments.

nbn will investigate the circumstances of the incident(s) or fault(s) detailed in the Service Request comments to assess if a Network Fault exists. If **nbn** considers that there is no Network Fault which affects your organisation, its Downstream Service Providers or Contracted End Users, **nbn** will inform your organisation's relevant technical representative of, and update the Service Request with, the results of **nbn**'s investigation.

5.4.1.1 Incident Priority

Refer to the [nbn[®] Ethernet Service Levels Schedule](#) for a description of how the incident priority of a Network Fault will be determined.

5.4.1.2 Trouble Ticket Contents (submitted by nbn)

Infrastructure Restoration Trouble Tickets will contain all of the following information:

- The unique Trouble Ticket ID
- The services and/or Products affected by the Network Fault (by way of listing the affected AVCs/CVCs)

- Description and type of the Network Fault
- Date and time at which the Network Fault is identified by **nbn**
- The geographic area affected
- The cause of the Network Fault, where known
- An estimate of the timeframe for rectification of the Network Fault, where known
- Any additional relevant information.

If **nbn** becomes aware that any of the information above is no longer current, or is otherwise inaccurate, then it will update the Infrastructure Restoration Trouble Ticket as soon as practicable.

nbn® Operational Targets for providing Network Fault Updates are set out in the [nbn® Ethernet Service Levels Schedule](#).

5.4.2 Customer Impact Statement Reports for Network Faults

Following a Network Fault classified as Priority Critical (in accordance with the [nbn® Ethernet Service Levels Schedule](#)) or where **nbn** and your organisation agree that it is appropriate, your organisation may request a Customer Impact Statement Report.

The Customer Impact Statement Report provides a description containing the following information:

- The timeline for the management of the event
- A description of the extent of the impact to services
- The underlying cause
- How the Network Fault was resolved
- The follow-up actions taken.

To the extent the Network Fault relates to a Type 2 Facility or other infrastructure not owned or controlled by **nbn**, the information included in the Customer Impact Statement Reports will be limited to the information **nbn** is able to provide, based on its arrangements with the Underlying Facility Provider or other infrastructure owner.

5.4.2.1 Requesting a Customer Impact Statement Report

Your organisation may request a Customer Impact Statement Report by completing a Customer Report Request Email and emailing it to your organisation's Operational Point of Contact as specified in the **Contact Matrix**.

Your organisation must provide the following details in the Customer Report Request Email:

- Incident Number: Incident number for the event
- Criteria: Priority must be Critical (unless otherwise agreed by **nbn**)
- Reason for Request
- Contact Name
- Contact Phone number(s)
- Contact email address.

If the request meets the criteria set out above, **nbn** will send an acceptance notification to your organisation, prior to creating and sending the report.

If the request does not meet the criteria set out above, **nbn** will send an email to your organisation explaining why the request was rejected.

5.4.2.2 Submission period

Your organisation must submit the request for a Customer Impact Statement Report within 20 Business Days of the closure of the Trouble Ticket associated with the Network Fault.

5.4.2.3 Delivery of the report

If **nbn** accepts your organisation’s request, **nbn** will endeavour to provide the Customer Impact Statement Report to your organisation within 15 Business Days of the date that **nbn** sends the relevant acceptance notification to your organisation under section 5.4.2.1 [Requesting a Customer Impact Statement Report](#).

5.5 Planned Outages and Emergency Outages

5.5.1 Planned Outage

A Planned Outage may be carried out when **nbn** or a third party implements a change (including a change to an electricity distribution network) that may impact the services and/or Ordered Products provided by **nbn**, including the **nbn**® Platform Interfacing Service.

5.5.1.1 Interactions: Planned Outage

The following diagram illustrates the interactions between your organisation and **nbn** that can arise from a Planned Outage.

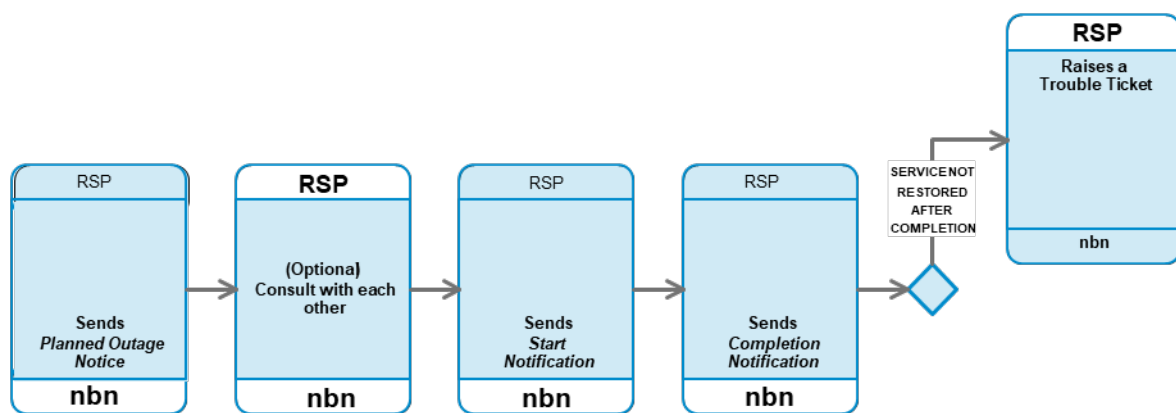

Description

The following table describes the interactions between your organisation and **nbn** that can arise from a Planned Outage.

Who	Activity
nbn ...	Sends your organisation a Planned Outage Notice.
nbn and Your organisation...	Consult in accordance with clause C15.1 of the Head Terms .
nbn...	Sends your organisation a Start Notification.
nbn...	<i>(Upon completion of the Planned Outage)</i> Sends your organisation a Completion Notification.
Your organisation...	<i>(If the service is not restored following completion of the Planned Outage)</i> Must raise a Trouble Ticket with nbn in relation to that issue.

5.5.1.2 Notification Channel

nbn will send Planned Outage Notices, Start Notifications and Completion Notifications to the relevant email address for your organisation as specified in the **Contact Matrix**.

5.5.1.3 Planned Outage Notice: Contents

In each Planned Outage Notice, **nbn** will include all of the following information (as applicable):

- A unique reference number
- Start and end date/time for the proposed Planned Outage
- Details and timeframes of the services and/or Ordered Products that will, or are likely to be, affected (if any); this will include, where known, the impact of the Planned Outage on your organisation (if any)
- The expected timeframe for the implementation of the Planned Outage
- If the Planned Outage is an:
 - FTTC Rollout Planned Outage
 - HFC Rollout Planned Outage;
 - NPIS Preventative Maintenance Outage;
 - Fibre Upgrade Outage;
 - NNI Migration Outage; or
 - NTD Replace Outage
- If the Planned Outage is an NPIS Preventative Maintenance Outage, the reason for the NPIS Preventative Maintenance Outage
- If the Planned Outage will affect the **nbn**[®] Platform Interfacing Service, any workarounds that **nbn** will implement.

nbn will perform Planned Outages in accordance with the timeframes set out in the relevant Planned Outage Notice.



Important: Information provided by **nbn** regarding a Planned Outage at a Type 2 Facility will be limited to the information **nbn** is able to provide, based on its arrangements with the Underlying Facility Provider.

5.5.1.4 Planned Outage Activities: Times

Subject to clause C15 of the [Head Terms](#), **nbn** will provide your organisation with:

- At least 10 Business Days' notice of a Planned Outage, other than for NPIS Preventative Maintenance Outages (see below), NNI Migration Outages (see below), Fibre Upgrade Outages (see section [5.5.5 Fibre Upgrade Outage](#)) and NTD Replace Outages (see section [5.5.7 NTD Replace Outage](#));
- In respect of an NPIS Preventative Maintenance Outage, as much notice as reasonably practicable in the circumstances but, in any event, by 5pm AET on the day in which the relevant Planned Outage Window for that NPIS Preventative Maintenance Outage commences;
- In respect of an NNI Migration Outage, at least 1 Business Day notice; or
- Where the relevant change is to perform any work including maintenance, repair, rationalisation or remediation involving any electricity distribution network to which the **nbn**[®] Network is connected, as much notice as is feasible in the circumstances having regard to **nbn**'s dependence on any relevant third party.

Will **nbn** perform Planned Outage activities outside of these times?

Yes, including (but not limited to) any of the following circumstances:

- **nbn** needs to perform Planned Outage activities during the day (as a result of, for example, health, safety and environment issues)
- **nbn** needs to accommodate the requirements of a Third Party Supplier.

nbn will restore the services and/or Ordered Products affected by the Planned Outage within the timeframes set out in the related Planned Outage Notice.

Note: If a Planned Outage event extends beyond the notified Planned Outage period, **nbn** will treat and manage the outage as a Service Fault. If **nbn** becomes aware that a Planned Outage has not been restored, it will raise a Trouble Ticket.

If the Planned Outage relates to a Type 2 Facility, **nbn** may extend the notified Planned Outage period for that Planned Outage and will provide your organisation with notice of any such extension.

5.5.1.5 Planned Outage Completion

nbn will notify your organisation of the completion of a Planned Outage by sending a Completion Notification to your organisation through the **nbn**® Service Portal or B2B Access.

If, on receipt of the Completion Notification, your organisation reasonably considers either or both of the following have occurred, your organisation may submit a Trouble Ticket:

- A Planned Outage has not been restored
- Your organisation's services and/or Ordered Products have been adversely affected by the Planned Outage, beyond what was originally expected or notified.

Note: Normal Trouble Ticket processes apply in dealing with a Trouble Ticket raised for this purpose.

5.5.2 HFC Rollout Planned Outage



Important: This section applies to **nbn**® Ethernet (HFC).

nbn will use all reasonable endeavours to ensure that:

- Daytime HFC Rollout Planned Outages (occurring during the hours of 7am to 3pm) take place only during the 6 months following the "Actual Ready for Service Date" for the SAM in which the affected Ordered Product is supplied (as listed in the Historical Rollout Region List); and
- An Ordered Product will be affected by daytime HFC Rollout Planned Outages on one day only in that 6 month period.

5.5.3 FTTC Rollout Planned Outage



Important: This section applies to **nbn**® Ethernet (FTTC).

FTTC Rollout Planned Outages may occur during the hours of 7am to 3pm.

5.5.4 Same POI Migration Planned Outage

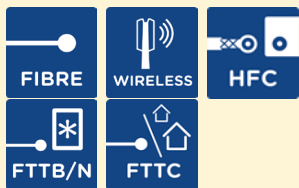

This section applies to **nbn**® Ethernet (Fibre), **nbn**® Ethernet (Wireless), **nbn**® Ethernet (HFC), **nbn**® Ethernet (FTTB), **nbn**® Ethernet (FTTN) and **nbn**® Ethernet (FTTC).

Same POI Migration Planned Outages may occur during the hours of 11pm to 6am. If your organisation has submitted a Same POI Migration Order, **nbn** will not be required to consult with your organisation in relation to the corresponding Same POI Migration Planned Outage for the purposes of clause C15 of the [Head Terms](#).

5.5.5 Fibre Upgrade Outage



Important: This section applies to **nbn**® Ethernet (FTTC).

nbn may determine that **nbn**[®] Network changes are needed to complete an Installation related to an **nbn**[®] Ethernet (Fibre) Ordered Product under this Agreement or an Other Wholesale Broadband Agreement in respect of a Premises that is served the FTTC Network.

In those circumstances, there may be a temporary service interruption in respect of ordered products supplied to that Premises and to other Premises that are associated with the **nbn**[®] DPU used to serve that Premises. **nbn** will provide your organisation with at least 1 Business Days' notice of such interruption.

Any such Fibre Upgrade Outage may occur during the hours of 7am to 7pm in the place where such an Outage occurs or is to occur.

5.5.6 NNI Migration Outage

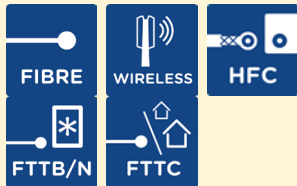

This section applies to **nbn**[®] Ethernet (Fibre), **nbn**[®] Ethernet (Wireless), **nbn**[®] Ethernet (HFC), **nbn**[®] Ethernet (FTTB), **nbn**[®] Ethernet (FTTN) and **nbn**[®] Ethernet (FTTC).

nbn will not be required to consult with your organisation in relation to any NNI Migration Outage for the purposes of clause C15 of the [Head Terms](#).

5.5.7 NTD Replace Outage

Where **nbn** performs an NTD Replace, there will be a temporary service interruption in respect of any ordered products supplied to the NTD being replaced. If your organisation and an Other RSP are both acquiring ordered products in respect of the same NTD, **nbn** will provide your organisation and that Other RSP with at least 1 Business Days' notice of such interruption.

5.5.8 Planned Outage Queries

Your organisation may query the status of the Planned Outage Notice either through the **nbn**[®] Service Portal or by directly contacting the planned change contact (as specified in the **Contact Matrix**) via email or telephone.

5.5.9 Emergency Outages

nbn will notify your organisation of an Emergency Outage by sending a notification to your organisation through the **nbn**[®] Service Portal or B2B Access (**Emergency Outage Notice**).

Note: **nbn** may not be able to notify your organisation before the start of an Emergency Outage.

nbn will, where feasible, endeavour to identify the following in any Emergency Outage Notice:

- The services and/or Ordered Products used by your organisation that will be, or are likely to be, affected by the Emergency Outage
- The expected time frames for the implementation of the Emergency Outage.

Note: If your organisation becomes aware that any services and/or Ordered Products are affected by an Emergency Outage other than as described in the Emergency Outage Notice or are not restored within the timeframe specified in the Emergency Outage Notice, your organisation may raise a Trouble Ticket, whereupon **nbn** will treat and manage the outage as a Service Fault.



Important: nbn may, at its discretion, not provide an Emergency Outage Notice to your organisation in respect to an Emergency Outage related to an Installation or the investigation of the Trouble Ticket performed by way of Commitment where no Actual Trouble Ticket Appointment is required to be scheduled. This does not affect the notifications detailed in section [6.8.1 Trouble Ticket – Fault Location](#) that your organisation must provide to the relevant End User, including in respect to an Outage that affects (or is likely to affect) the End Users' access to emergency services.

5.5.10 Embargo Periods

nbn may establish an Embargo Period (e.g. New Year's Day, Easter Sunday, Mothers' Day, etc.) by giving your organisation 60 Business Days notice. If nbn determines that an Embargo Period will be established, nbn will notify your organisation of the details.

Your organisation may, within 2 Business Days of being notified of an Embargo Period being established, request that the Embargo Period be deferred. If your organisation requests deferral of an Embargo Period, nbn will endeavour to review and respond to your organisation's request within 5 Business Days.

Your organisation may also suggest in writing that an Embargo Period be established.

If your organisation suggests an Embargo Period, nbn will endeavour to review the suggestion and respond, in writing, within 5 Business Days.

5.5.11 Sun Transit Events



This section applies for nbn® Ethernet (Satellite).

There will be a brief service interruption to nbn® Ethernet (Satellite) for the duration of a Sun Transit Event. This service interruption is not an Outage or a Service Fault.

nbn will notify your organisation of a Sun Transit Event at least 30 days in advance by contacting the planned change contact (as specified in the *Contact Matrix*).

Note: nbn will provide indicative times and dates for each Sun Transit Event in relation to several reference sites. However, the exact timing of a Sun Transit Event at a particular Premises will depend on the geographic location of the Premises and on the nbn® satellite which is used in relation to the supply of nbn® Ethernet to that Premises.

5.6 Network protection

5.6.1 Repair Profile



A Repair Profile is a spectrally limited VDSL2 stability profile designed to preserve the integrity of the VDSL2 vectoring system. nbn may impose a Service Reduction in accordance with the [Head Terms](#) and [nbn® Ethernet Product Terms](#) in respect of an nbn® Ethernet (FTTB) or nbn® Ethernet (FTTN) Ordered Product by (without limitation) placing that Ordered Product into a Repair Profile.

nbn will notify your organisation via the nbn® Service Portal or B2B Access if it places an Ordered Product into a Repair Profile.

The applicable Charges remain payable when an Ordered Product is in Repair Profile.

While the Ordered Product is in Repair Profile:

- Your organisation cannot place a Modify Order for that Ordered Product to modify the VDSL2 stability profile or primary bandwidth profile
- In accordance with the [nbn[®] Ethernet Product Description](#), the downstream PIR and upstream PIR at the UNI may be significantly less than the downstream PIR and upstream PIR of the bandwidth profile ordered by your organisation in respect of the Ordered Product
- Your organisation must not raise a Trouble Ticket for a fault relating to the Information Rate (PIR and CIR) of the Ordered Product. In this case, **nbn** will update the Trouble Ticket Status of the Trouble Ticket to **Resolved**, and send your organisation a Resolved Notification via the **nbn[®]** Service Portal and/or B2B Access. The Resolved Notification will provide a resolution code and a description reflecting there was no fault found and where relevant, associated comments to provide further information that may assist your organisation to understand the outcome of **nbn's** Trouble Ticket investigation in accordance with section [5.2.6 External Faults](#), and may charge your organisation a No Fault Found (No Truck Roll Required) Charge or No Fault Found (Truck Roll Required) Charge (as applicable), as specified in the [nbn[®] Ethernet Price List](#).

Your organisation may raise a Service Request via the **nbn[®]** Service Portal or B2B Access to request that the profile of the Ordered Product be adjusted from Repair Profile to Standard Profile or Stable Profile. **nbn** will investigate and determine whether it is appropriate to amend the VDSL2 stability profile of the Ordered Product, and will notify your organisation of the outcome of the investigation, including any change to the VDSL2 stability profile.

Module 6: Appointments



6.1 In This Module

6.1.1 Introduction

This module describes the processes and activities that your organisation must undertake in connection with:

- Installation Appointments; and
- Trouble Ticket Appointments.

This module is made up of the following sections:

Section	Description
6.2 Appointment Overview	This section describes an overview of Appointments including the Appointment Status, life-cycle and other relevant details
6.3 New Appointments	This section describes the process and associated business rules for creating a new Appointment
6.4 Rescheduling Appointments	This section describes the process and associated business rules for rescheduling an Appointment and updating the details associated with an Appointment
6.5 Cancelling Appointments	This section describes the processes and associated business rules for cancelling Appointments
6.6 Missed Appointments	This section describes the processes and associated business rules for Missed Appointments
6.7 Installation Specific Processes	This section describes the processes and associated business rules for Installation Appointments. This section does not apply to Trouble Ticket Appointments.
6.8 Trouble Ticket Specific Processes	This section describes the process and associated business rules for Trouble Ticket Appointments. This section does not apply to Installation Appointments.

6.1.2 Appointment Scenarios

See the *nbn® Operations User Guide* which sets out details of the relationship between





- Installations, Appointments, and the associated changes in Order Status and Installation Appointment Status;
- Trouble Tickets, Trouble Ticket Appointments and the associated changes in Trouble Ticket Status and Trouble Ticket Appointment Status.

6.2 Appointment Overview

6.2.1 Appointment Status; description

The following table defines the different Appointment Status states that apply and the activities which must be performed by **nbn** or your organisation in those circumstances, or the options that apply in those circumstances.

Status	Description
Reserved	Your organisation or nbn reserves an Appointment on behalf of your organisation. nbn allocates a unique Appointment ID and validates the Appointment. Note: Your organisation can request that the Reserved Appointment be rescheduled in accordance with section 6.4 Rescheduling Appointments .

Status	Description
	<p> Important:</p> <ul style="list-style-type: none"> • The Appointment must be associated with a valid order or Trouble Ticket. • Where the order or Trouble Ticket has a status of In Progress – Pending, your organisation must confirm that all required information has been provided and all required actions have been completed prior to reserving a new Appointment or rescheduling an existing Appointment in connection with that order or Trouble Ticket. • If nbn does not receive all of the information required or requested from your organisation in order to validate the Appointment request prior to the expiration of the Appointment request, nbn will cancel the Appointment and change the Appointment Status to Cancelled. • Where applicable, your organisation must arrange for the Appointment Representative to be present at the time of the Appointment. • For nbn[®] Ethernet (Satellite), when your organisation reserves an Appointment through the nbn[®] Service Portal or B2B Access, your organisation is reserving capacity. nbn will attempt to contact the Appointment Representative to schedule the Actual Appointment in accordance with section 6.3.2 New Appointment Process.
Booked	<p>nbn successfully validates the Appointment request and confirms the Appointment.</p> <p> (For Appointments in respect of nbn[®] Ethernet (Satellite)) nbn will then attempt to make contact with the Appointment Representative) to schedule an Actual Appointment</p> <p>Your organisation must also keep Appointment Representative informed of any changes to the Appointment in accordance with section 6.4 Rescheduling Appointments.</p> <p> Exception: For nbn[®] Ethernet (Satellite) your organisation’s responsibility for communicating the Appointment cancellation or reschedule with the Appointment Representative is limited to cases where your organisation has initiated the cancellation or reschedule. In all other cases nbn is responsible for communicating all Appointment rescheduling with the Appointment Representative.</p>
In Progress	<p>nbn undertakes the necessary field work for the Appointment.</p> <p>Example: The activation of a service or progressing a Trouble Ticket</p> <p> Important: Your organisation can only reschedule or cancel an In Progress Appointment in accordance with section 6.4 Rescheduling Appointments and section 6.5 Cancelling Appointments(respectively).</p>
Complete	<p>The Appointment has concluded.</p> <p>Examples:</p> <ul style="list-style-type: none"> • The technician has finished the Installation or resolved the Service Fault, and left the site. • The Appointment Representative is not in attendance at the Premises when the technician arrives for the Appointment. <p>See the nbn[®] Ethernet Price List for details of Charges which may apply for Missed Appointments.</p>

Status	Description
Incomplete	<p>nbn notifies your organisation that a Booked or In Progress Appointment could not start or be completed.</p> <p>Example reasons include:</p> <ul style="list-style-type: none"> • Weather conditions • Hazard • Network event • Next-day visit required for completion (e.g. first job of the morning). <div style="background-color: #fff9c4; padding: 10px; margin-top: 10px;"> <p> Important: If an Appointment has a status of Incomplete and the Appointment is still required to complete the order or rectify the Service Fault (as applicable), your organisation must reschedule the Appointment in accordance with section 6.4.1 Updating and Rescheduling Appointments</p> </div>
Cancelled	<ul style="list-style-type: none"> • Either your organisation or nbn has successfully cancelled either the order or Trouble Ticket related to the Appointment • A Reserved or Booked Appointment if the Booked Appointment was cancelled before the timeframes set out in section 6.5.3 Required notice periods for Appointment cancellation by your organisation. • nbn has received a late cancellation request, during the Booked stage, within the timeframes set out in section 6.5.3 Required notice periods for Appointment cancellation by your organisation. • nbn has received a communication from the Contracted End User or Appointment Representative indicating that a prerequisite for the Appointment will not be met (such as attendance at the Premises or consent to removal of a Power Supply with Battery Backup Unit). • nbn notifies your organisation that a Reserved Appointment has expired.

6.2.2 Appointment Life Cycle

The following diagram illustrates the life-cycle of an Appointment including the different Appointment Status states that may apply for both Installation Appointments and Trouble Ticket Appointments.

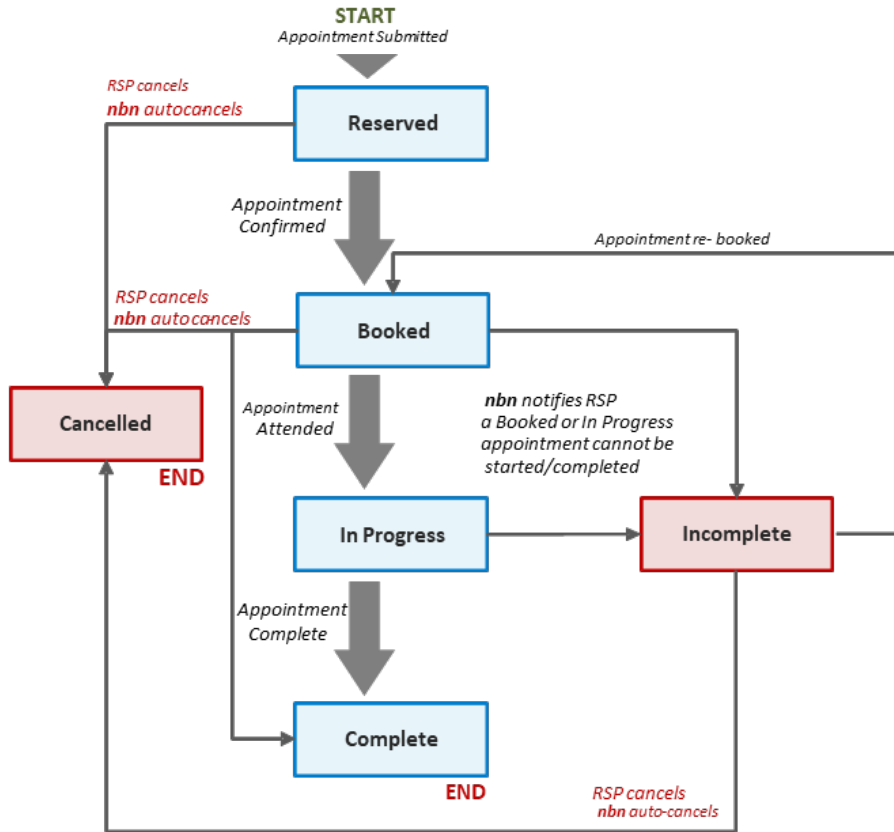

6.2.3 Appointment Blocks

nbn sets the minimum Appointment block duration, based on the location of the required attendance by **nbn**. This varies from 1 hour, to the maximum permitted by the [nbn® Ethernet Service Levels Schedule](#).

6.2.4 Appointment Completion and Communicating Changes

nbn will endeavour to complete as many Installations and resolve as many Trouble Tickets on the first attempt, and within the first booked Appointment period, as reasonably possible. However, situations may arise that prevent this from occurring.

nbn communicates all changes to the status of an Appointment through the **nbn®** Service Portal or B2B Access, using the relevant Appointment ID.

6.2.5 Appointment Communication Responsibilities

The purpose of this section [6.2.5 Appointment Communication Responsibilities](#) is to ensure that the Appointment is at a time when the Appointment Representative is present to allow **nbn** to access the Premises and perform the Installation or to resolve the Service Fault associated with a Trouble Ticket.



Important: Not all types of Installations for **nbn®** Ethernet require the Appointment Representative to be at the Premises during the Appointment (see section [6.7.1 Selecting Appointments](#)).

The following table sets out the details of each party’s obligations to communicate reservations, cancellations and rescheduled appointment details to End Users and others:

Network	Responsibility for Appointment Representative notification
---------	--

Appointment times: Keep Appointment Representatives informed!



Important: Your organisation is responsible for communicating all Appointment bookings, cancellations and reschedules with the Appointment Representative, including in respect of Non Standard Installations and Professional Wiring Service.

Where the Appointment Representative is required to be available at the Premises for the Appointment, your organisation must communicate with each Appointment Representative about available Appointment times (as determined by your organisation through the **nbn**[®] Service Portal or B2B Access) to ensure that the Appointment is at a time when the Appointment Representative is available to enable **nbn** to access the Premises and perform the work required.

Important: For all Appointment bookings, cancellations and reschedules, **nbn** is responsible for communicating with the Appointment Representative, except where your organisation has initiated the cancellation or reschedule (in which case, your organisation is responsible for communicating the Appointment cancellation or reschedule with the Appointment Representative).

Important: When your organisation reserves an Appointment via the **nbn**[®] Service Portal or B2B Access, your organisation is reserving capacity (that is, the reserved Appointment may not be the date that the Appointment will occur).

Your organisation must:

- Inform the Appointment Representative of the expected timeframe for completion of the Installation or resolution of the Trouble Ticket, based on the Service Levels or Operational Targets (as applicable) for the Premises
- Provide any Appointment Representative contact details requested by **nbn** when reserving the Appointment
- Inform the Appointment Representative that **nbn** will:
 - within two Business Days of your organisation submitting an order with a valid Appointment ID; or
 - within three days of your organisation submitting a Trouble Ticket, with a valid Appointment ID,
 contact them to schedule an Actual Appointment.

nbn will:

- Attempt to contact the Appointment Representative within the following timeframes, to schedule the Actual Appointment:
 - within two Business Days of your organisation submitting the order with a valid Appointment ID
 - within three Business Days of your organisation submitting the Trouble Ticket with a valid Appointment ID.

*(If **nbn** makes contact with the Appointment Representative within five Business Days of your organisation submitting the order with a valid Appointment ID or within ten Business Days of your organisation submitting the Trouble Ticket with a valid Appointment ID):*

- Notify your organisation via the **nbn**[®] Service Portal or B2B Access of the Actual Appointment details
- Attempt to contact the Appointment Representative approximately 24 hours prior to the Actual Appointment date to confirm their attendance

Note: If **nbn** cannot make contact with the Appointment Representative 24 hours prior to the Actual Appointment to confirm the attendance, **nbn** will still attend the Actual Appointment. **nbn** may charge your organisation a Missed Appointment Charge in accordance with section [6.6 Missed Appointments](#) and the [nbn[®] Ethernet Price List](#).

- *(If **nbn** cannot make contact with the Appointment Representative within five Business Days of your organisation submitting the order with a valid Appointment ID or within ten Business Days of your organisation submitting the Trouble Ticket with a valid Appointment ID) Change the associated Order Status or Trouble Ticket Status to In Progress – Pending and request that your organisation reschedules the Appointment (i.e. request Appointment capacity via the **nbn**[®] Service Portal).*



Important:

- For Installation Appointments, **nbn** may cancel an order if the order has been In Progress - Pending for 5 Business Days, or if the order is placed in

In Progress - Pending on two occasions because **nbn** has been unable to make contact with the Appointment Representative to schedule an Actual Appointment (see section 4.5.1.6 [Order Status Life-cycle](#)).

- For Trouble Ticket Appointments, **nbn** may resolve a Trouble Ticket if the Trouble Ticket has been In Progress - Pending status for 5 Business Days, or if the Trouble Ticket is placed in In Progress - Pending on two occasions because **nbn** has been unable to make contact with the Appointment Representative to schedule an Actual Appointment (see section 5.2.2 [Trouble Tickets](#))

6.2.6 Appointments and Personal Information

Clause D2.2 of the [Head Terms](#) governs how **nbn** will handle any Personal Information of an Appointment Representative provided by your organisation that relates to an Appointment.

6.2.7 Querying the Status of an Appointment







Your organisation may use the **nbn**® Service Portal or B2B Access to search for the Appointment Status of an Appointment (**Appointment Enquiry**).

In order to make an Appointment Enquiry, your organisation will require the relevant Appointment’s Appointment ID.

6.2.8 Reserved Appointments

When your organisation reserves an Appointment, your organisation must associate it to an order or Trouble Ticket within the following timeframes (**Sunset Period**). If the Appointment still has the Reserved status when the Sunset Period expires, **nbn** will cancel the Appointment and update its Appointment Status to Cancelled.

See section 6.5.2 [Cancelled Appointment \(by nbn\)](#).

Network	Sunset Period
    	<ul style="list-style-type: none"> • 2 Business Days for Installation Appointments • 24 hours for Trouble Ticket Appointments
	<ul style="list-style-type: none"> • 24 hours for Installation and Trouble Ticket Appointments.



Important: Your organisation must not associate reserved Appointments to an order amended from:

- RSP Professional Installation – FTTC; or
- End User Installation – FTTC (RSP Dispatched); or
- End User Installation – FTTC (**nbn** Dispatched)

to **nbn** Professional Installation - FTTC.

6.2.9 Priority Assistance Appointments

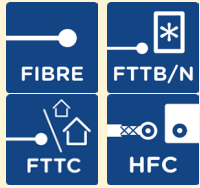

Important: This section applies to Access Component orders and Trouble Tickets for **nbn**[®] Ethernet (Fibre), **nbn**[®] Ethernet (FTTB), **nbn**[®] Ethernet (FTTN), **nbn**[®] Ethernet (HFC) and **nbn**[®] Ethernet (FTTC).

6.2.9.1 Booking Downstream Priority Assistance Service Appointments

If your organisation places an order for a Priority Assistance Connection, or submits a Trouble Ticket for a Priority Assistance Fault which requires an Appointment, **nbn** and your organisation will perform the following activities in relation to that Appointment:

Who	Activity
Your organisation...	Determines that the Appointment Representative is supplied with a Downstream Priority Assistance Service.
Your organisation...	Your organisation is required to reserve the first available Appointment and must inform the Appointment Representative of the Appointment.
Your organisation...	Must telephone the nbn [®] 24/7 Priority Assistance Contact Centre where suitable appointments are not available within the required Service Level, (see the Contact Matrix for details to schedule the Appointment for a Priority Assistance Connection or Priority Assistance Fault).
nbn ...	Ensures and confirms that the Appointment is flagged as relating to a Priority Assistance Connection or Priority Assistance Fault and is correctly scheduled.

6.2.9.2 Cancelling or Rescheduling Downstream Priority Assistance Service Appointments

For a Priority Assistance Connection or Priority Assistance Fault, if the Appointment is to be rescheduled or where your organisation wishes to cancel an Appointment, then **nbn** and your organisation will perform the following activities in relation to the relevant Appointment:

Who	Activity
Your organisation...	Must inform the Appointment Representative of their scheduled Appointment or cancellation.
Your organisation...	Must telephone the nbn 24/7 Priority Assistance Contact Centre (details of which are specified in the Contact Matrix) and advise it of the rescheduled Appointment or cancellation.
nbn...	Confirms that the Appointment flagged as relating to a Priority Assistance Connection or Priority Assistance Fault is correctly scheduled or cancelled.

6.3 New Appointments

Your organisation must schedule all Appointments using the **nbn**[®] Service Portal or B2B Access.



Important: Where an order or Trouble Ticket has a Status of **In Progress – Pending**, your organisation must ensure that all required information has been provided and all required actions have been completed prior to reserving a new Appointment or rescheduling an existing Appointment in connection with that order or Trouble Ticket.



Important: When your organisation reserves an Appointment in respect of **nbn**[®] Ethernet (Satellite) your organisation is reserving capacity (that is, the reserved Appointment may not be the date that the Appointment will occur). **nbn** will contact the Appointment Representative to schedule the Actual Appointment in accordance with this section [6.3 New Appointments](#).

The steps comprising the new Appointments process, and the associated activities **nbn** and your organisation must perform (or, where indicated, may perform) in relation to each step, are defined in this section [6.3 New Appointments](#).

See section [6.2.5 Appointment Communication Responsibilities](#) for details of responsibility for communications regarding appointments.

6.3.1 Appointment IDs



When your organisation accepts a proposed Appointment, or selects a valid Appointment time, **nbn** will allocate a unique Appointment ID through the **nbn**[®] Service Portal (or B2B Access if applicable).







Important: Your organisation must associate the Appointment ID when submitting an Installation order or submitting a Trouble Ticket, through the **nbn**[®] Service Portal or B2B Access.

6.3.2 New Appointment Process

nbn and your organisation will comply with the following process when your organisation reserves a new Appointment

Who	Activity
<p>Your organisation...</p>	<p>Must communicate with the relevant Appointment Representative about available Appointment times (as determined by your organisation through the nbn[®] Service Portal or B2B Access). This is to ensure that the Appointment is at a time when the Appointment Representative is present to allow nbn to access the Premises and perform the required work.</p> <div style="background-color: #fff9c4; padding: 10px; margin: 10px 0;">  <p>Important: For nbn[®] Ethernet (Satellite), your organisation must:</p> <ul style="list-style-type: none"> • Inform the Appointment Representative of the expected timeframe for completion of the Installation or fault investigation and/or rectification, based on the Service Levels or Operational Targets (as applicable) for the Premises • Provide additional Appointment Representative contact details as required by nbn when reserving the Appointment • Inform the Appointment Representative that nbn will contact them to schedule the Actual Appointment (where required). </div> <p>Note: For Centralised Deployments, your organisation must enter the relevant Multi-Premises Site contact as the secondary contact in the Appointment reservation.</p> <div style="background-color: #fff9c4; padding: 10px; margin: 10px 0;">  <p>Important: Always select an Appointment that takes into consideration both of the following:</p> <ul style="list-style-type: none"> • The amount of time that your organisation, operating in accordance with its ordinary business practices, takes to associate Appointments with Access Component orders or Trouble Tickets • The lead time required by nbn for the order, (for orders refer to section 6.7.2 Order Lead Times) or Trouble Ticket (which will commence when your organisation associates the Appointment with the order or Trouble Ticket). </div> <p>Note: See the nbn[®] Ethernet Price List for details of Charges applicable for booking After Hours Installation Appointments and Co-ordinated Appointments.</p>

Who	Activity
Your organisation...	<p>Must schedule an Appointment:</p> <ul style="list-style-type: none"> Through the nbn[®] Service Portal or B2B Access and ensure that the Appointment ID is linked to a valid order or Trouble Ticket; or (Where a Trouble Ticket Appointment is in respect of an Enhanced Fault, if your organisation wishes to request a Trouble Ticket Appointment outside of the Appointment windows available in the nbn[®] Service Portal (e.g. on Sundays)), your organisation must contact nbn as detailed in the Contact Matrix, (Where an Appointment is for a Priority Assistance Fault or Priority Assistance Connection, if your organisation wishes to request an Appointment outside of the Appointment windows available in the nbn[®] Service Portal (e.g. on weekends)), your organisation must contact nbn as detailed in the Contact Matrix. <div style="background-color: #ffffcc; padding: 10px;"> <p> Important:</p> <ul style="list-style-type: none"> When your organisation reserves an Appointment related to nbn[®] Ethernet (Satellite), your organisation is reserving capacity. If you reserve an Appointment in accordance with the requirements above, nbn will contact the Appointment Representative to schedule the Actual Appointment as set out below in this table. When reserving an Appointment for a Priority Assistance Fault or Priority Assistance Connection, your organisation must reserve the first available Appointment. (Refer to section 6.2.9 Priority Assistance Appointments). nbn may (in its discretion) agree to schedule a Trouble Ticket Appointment outside of the Appointment windows available in the nbn[®] Service Portal or B2B Access where your organisation contacts nbn as detailed in the Contact Matrix and the Trouble Ticket Appointment is in respect of an Enhanced Fault. Your organisation must procure, and must ensure that Downstream Service Providers procure, that the Contracted End User consents for nbn Personnel to carry out In-Premises Wiring Activities as part of Remediation. </div>
nbn...	<p>Sets the Appointment Status to Reserved and allocates a unique Appointment ID through the nbn[®] Service Portal (or B2B Access if applicable).</p>
nbn...	<p>Validates your organisation's Appointment request and, if valid, changes the Appointment Status to Booked.</p>
nbn ... 	<ul style="list-style-type: none"> Will attempt to contact Appointment Representative within the following timeframes, to reschedule the Appointment: <ul style="list-style-type: none"> within two Business Days of your organisation submitting the order with a valid Appointment ID within three Business Days of your organisation submitting the Trouble Ticket with a valid Appointment ID. (If nbn makes contact with the Appointment Representative within five Business Days of your organisation submitting the order with a valid Appointment ID or within ten Business Days of your organisation submitting the Trouble Ticket with a valid Appointment ID): <ul style="list-style-type: none"> Notifies your organisation via the nbn[®] Service Portal or B2B Access of the Actual Appointment details Attempts to contact the Appointment Representative approximately 24 hours prior to the Actual Appointment to confirm their attendance. <p>Note: If nbn cannot make contact with the Appointment Representative 24 hours prior to the Actual Appointment to confirm the attendance, nbn will still attend the Actual Appointment. nbn may charge your organisation a Missed Appointment Charge in accordance with section 6.6.1 Missed Appointments (by your Organisation) and the nbn[®] Ethernet Price List.</p> (If nbn cannot make contact with the Appointment Representative within five Business Days of your organisation submitting the order with a valid Appointment ID or within ten Business Days of your organisation submitting the Trouble Ticket with a valid Appointment ID) Change the associated Order Status or Trouble Ticket Status to In Progress – Pending and request that your organisation reschedules the Appointment (i.e. request Appointment capacity via the nbn[®] Service Portal).

Who	Activity
	<p> Important:</p> <ul style="list-style-type: none"> For Installation Appointments, nbn may cancel an order if the order has been In Progress - Pending for 5 Business Days, or if the order is placed in In Progress - Pending on two occasions because nbn has been unable to make contact with the Appointment Representative to schedule an Actual Appointment (see section 4.5.1.6 Order Status Life-cycle). For Trouble Ticket Appointments, nbn may resolve a Trouble Ticket if the Trouble Ticket has been In Progress - Pending status for 5 Business Days, or if the Trouble Ticket is placed in In Progress - Pending on two occasions because nbn has been unable to make contact with the Appointment Representative to schedule an Actual Appointment (see section 5.2.2 Trouble Tickets). nbn may cancel or reject an order or resolve a Trouble Ticket if your organisation has not confirmed all required information that nbn has requested or if nbn identifies that all requested actions have not been completed (see section 4.5.1.6 Order Status Life-cycle and section 5.2.3 Raising, Validating and Resolving a Trouble Ticket).
nbn...	<p>May, prior to the Appointment date, communicate with the Appointment Representative for whom your organisation has provided Personal Information, to confirm all of the following:</p> <ul style="list-style-type: none"> Installation or Trouble Ticket work requirements for the Premises That the Appointment Representative will be in attendance for the Appointment, where necessary. <p> Important: Not all types of Installation for nbn[®] Ethernet require the Appointment Representative to be at the Premises during the Appointment (see section 6.7.1 Selecting Appointments).</p>

6.3.2.1 Validation Problems with an Appointment ID

If **nbn** cannot validate an Appointment ID in an associated Access Component order or Trouble Ticket, **nbn** will change the Order Status or Trouble Ticket Status to **Acknowledged – Pending** or **In Progress - Pending** and update the “comments” field for the order or Trouble Ticket (as applicable).

In those circumstances, **nbn** and your organisation will perform the following activities.

nbn adds the following comments to the affected order or Trouble Ticket:	In response, your organisation may do one of the following:
<ul style="list-style-type: none"> A statement that the Appointment ID is invalid, and that the conditions relating to an Acknowledged – Pending or In Progress - Pending order or Acknowledged – Pending or In Progress – Pending Trouble Ticket now apply. A request that your organisation reserves a new Appointment. A request that your organisation amend the order to include the new Appointment’s Appointment ID. 	<ul style="list-style-type: none"> Reschedule an Appointment See section 6.4 Rescheduling Appointments. Cancel the Appointment See section 6.5 Cancelling Appointments. Amend the related order with the new Appointment’s Appointment ID See section 4.5.1.2 Amending Orders.

6.3.2.2 Confirming Appointments

nbn will confirm the Appointment request (and update the Appointment Status to Booked) if all of the following criteria are met:

- The current status of the Appointment is **Reserved**
- The Appointment is associated with a valid order or Trouble Ticket.

- The Appointment is for a valid address and has been requested for a suitable date and time
- The Appointment ID of the Reserved Appointment matches the Appointment ID provided by your organisation in the order or Trouble Ticket
- The **nbn**[®] Location ID for the Reserved Appointment matches the **nbn**[®] Location ID in the order or Trouble Ticket
- *(If applicable)* Where the relevant Order Status or Trouble Ticket Status is **Acknowledged – Pending** or **In Progress – Pending**, your organisation has confirmed that all required information has been provided and all required actions have been completed.
- *(If applicable)* The **Priority Assistance** value for the Trouble Ticket Appointment matches the Priority Assistance value in the Trouble Ticket
- *(If applicable)* The **Enhanced Fault** value for the Trouble Ticket Appointment matches the **Enhanced Fault** value in the Trouble Ticket.



Important:

- Where applicable, your organisation must arrange for the Appointment Representative to be present at the time of the Appointment.
- If **nbn** does not receive all of the information required or requested from your organisation in order to validate the Appointment request prior to the Sunset Period expiring (and the Appointment still has the Reserved status when the Sunset Period expires), **nbn** will cancel the Appointment and update its Appointment Status to Cancelled.
- For all Priority Assistance Faults, if the Priority Assistance value for the Trouble Ticket Appointment does not match the Priority Assistance value in the Trouble Ticket, the Trouble Ticket Appointment will be automatically cancelled by **nbn** and the Trouble Ticket placed into **Acknowledged – Pending** or **In Progress - Pending**. For example, if a Priority Assistance Appointment is raised against a non-priority assistance Trouble Ticket or vice versa, **nbn** will automatically cancel the appointment.
- For **nbn**[®] Ethernet (Satellite), when your organisation reserves an Appointment through the **nbn**[®] Service Portal or B2B Access, your organisation is reserving capacity. **nbn** will attempt to contact the Appointment Representative to schedule the Actual Appointment in accordance with section [6.3 New Appointments](#)

What happens if nbn rejects the Appointment request?

If **nbn** rejects the Appointment request, **nbn** will update the Appointment Status to **Cancelled** and notify your organisation providing the reason for the rejection, through the **nbn**[®] Service Portal or B2B Access. Your organisation can resubmit the Appointment request after making the necessary changes.

6.3.3 Appointment Windows

nbn will determine the Appointment window for each Appointment based on the location of the relevant Premises and the type of Appointment. For Co-ordinated Appointments, the Appointment window will always be to attend the Premises at a particular time.

6.4 Rescheduling Appointments



Note: The restrictions to rescheduling an Appointment in this section do not apply while an Appointment has a **Reserved** Appointment Status.

6.4.1 Updating and Rescheduling an Appointment







Important: Amending an Appointment through the **nbn**[®] Service Portal or B2B Access

As the previously-stored information will be replaced by the details submitted in the request, when updating Appointment details, your organisation must submit all details relating to the following:

- Personal Information of the Appointment Representative
- If required, additional comments via an RSP Enquiry regarding the Premises relating to the Installation or Trouble Ticket Appointment.

Your organisation may make changes to or reschedule an Appointment in the following circumstances and by undertaking the following activities.

Appointment Status	Reschedule options
<p>Booked</p>	<p><i>(For Co-ordinated Appointments, at least 24 hours prior to the scheduled Co-ordinated Appointment):</i></p> <ul style="list-style-type: none"> • Reschedule via the nbn[®] Service Portal or B2B Access. • Amend Personal Information or Appointment Representative details as applicable. <p><i>(For Co-ordinated Appointments, within 24 hours of the scheduled Co-ordinated Appointment)</i></p> <ul style="list-style-type: none"> • Directly contact nbn as detailed in the Contact Matrix
<p>Booked</p>	<p><i>(For Appointments relating to a Priority Assistance Transaction, at least 24 hours prior to the scheduled Appointment)</i></p> <ul style="list-style-type: none"> • Reschedule via the nbn[®] Service Portal or B2B access. • Amend Personal Information or Appointment Representative details as applicable. <p><i>(For Appointments relating to a Priority Assistance Transaction, within 24 hours prior to the scheduled Appointment)</i></p> <ul style="list-style-type: none"> • Directly contact nbn as detailed in the Contact Matrix. <div style="background-color: #FFF9C4; padding: 10px; margin-top: 10px;"> <p> Important: If your organisation is required to directly contact nbn as detailed in the Contact Matrix to reschedule an Appointment, nbn may reject that request (for example if a technician is at or approaching the Premises), in which case nbn will attend the Appointment and your organisation may incur a Missed Appointment Charge in accordance with the nbn[®] Ethernet Price List.</p> </div> <p><i>(For Appointments relating to a Premises in an Isolated Area or Limited Access Area, and not related to a Priority Assistance Transaction, at least 48 hours prior to the scheduled Appointment):</i></p> <ul style="list-style-type: none"> • Reschedule or amend via the nbn[®] Service Portal or B2B Access. • Amend Personal Information or Appointment Representative details as applicable. <p><i>(For Appointments relating to a Premises in an Isolated Area or Limited Access Area, and not related to a Priority Assistance Transaction, within 48 hours of the scheduled Appointment):</i></p> <ul style="list-style-type: none"> • Directly contact nbn as detailed in the Contact Matrix. <p><i>(For all other Appointments, at least 4 hours prior to the scheduled Appointment):</i></p> <ul style="list-style-type: none"> • Reschedule or amend via the nbn[®] Service Portal or B2B Access. • Amend Personal Information or Appointment Representative details as applicable. <p><i>(For all other Appointments, within 4 hours of the scheduled Appointment):</i></p> <ul style="list-style-type: none"> • Directly contact nbn as detailed in the Contact Matrix.
<p>Booked</p>	<p><i>(For Appointments relating to a Premises in an Isolated Area or Limited Access Area, at least 48 hours prior to the scheduled Appointment):</i></p> <ul style="list-style-type: none"> • Reschedule or amend via the nbn[®] Service Portal or B2B Access.

Appointment Status	Reschedule options
	<ul style="list-style-type: none"> Amend Personal Information or Appointment Representative details as applicable. <p><i>(For Appointments relating to a Premises in an Isolated Area or Limited Access Area, within 48 hours of the scheduled Appointment):</i></p> <ul style="list-style-type: none"> Directly contact nbn as detailed in the Contact Matrix. <p><i>(For all other Appointments, at least 1 Business Day prior to the scheduled Appointment):</i></p> <ul style="list-style-type: none"> Reschedule or amend via the nbn[®] Service Portal or B2B Access. Amend Personal Information or Appointment Representative details as applicable. <div style="background-color: #fff9c4; padding: 10px;"> <p> Important: If your organisation is required to directly contact nbn as detailed in the Contact Matrix to reschedule an Appointment, nbn may reject that request (for example if a technician is at or approaching the Premises), in which case nbn will attend the Appointment and your organisation may incur a Missed Appointment Charge in accordance with the nbn[®] Ethernet Price List.</p> </div> <p><i>(For all other Appointments, within 1 Business Day of the scheduled Appointment):</i></p> <ul style="list-style-type: none"> Directly contact nbn as detailed in the Contact Matrix.
<p>Booked</p> 	<p><i>For Appointments related to a Premises in an Urban Area, Major Rural Area, Minor Rural Area or Remote Area, at least 1 Business Day prior to the scheduled Actual Appointment:</i></p> <ul style="list-style-type: none"> Reschedule or amend via the nbn[®] Service Portal or B2B Access Amend Personal Information or Appointment Representative details as applicable <p><i>For Appointments related to a Premises in an Urban Area, Major Rural Area, Minor Rural Area or Remote Area, within 1 Business Day of the scheduled Actual Appointment:</i></p> <ul style="list-style-type: none"> Directly contact nbn as detailed in the Contact Matrix. <div style="background-color: #fff9c4; padding: 10px;"> <p> Important: If your organisation is required to directly contact nbn as detailed in the Contact Matrix to reschedule an Appointment, nbn may reject that request (for example if a technician is at or approaching the Premises), in which case nbn will attend the Appointment and your organisation may incur a Missed Appointment Charge in accordance with the nbn[®] Ethernet Price List.</p> </div> <p><i>For Appointments related to a Premises in an Isolated Area or Limited Access Area, at least 48 hours prior to the scheduled Actual Appointment:</i></p> <ul style="list-style-type: none"> Reschedule or amend via the nbn[®] Service Portal or B2B Access Amend Personal Information or Appointment Representative details as applicable <p><i>For Appointments related to a Premises in an Isolated Area or Limited Access Area, within 48 hours of the scheduled Actual Appointment:</i></p> <ul style="list-style-type: none"> Directly contact nbn as detailed in the Contact Matrix.
<p>In Progress</p>	<p>Your organisation may not amend or reschedule the order or Trouble Ticket Appointment.</p>
<p>Cancelled Complete</p>	<p>Your organisation may not reschedule the Appointment; a new Appointment must be requested.</p>
<p>Incomplete</p>	<p>As long as nothing (including but not limited to a hazard, mass service disruption, or network shortfall) prevents completion of the Appointment, your organisation may amend details of the Appointment via the nbn[®] Service Portal or B2B Access.</p>



6.4.2 Permitted Reasons for Rescheduling

Subject to section 6.4.1 [Updating and Rescheduling an Appointment](#) and under the following circumstances, either your organisation or **nbn** may reschedule an Appointment through the **nbn**® Service Portal or B2B Access in the following circumstances.



Important:

- When your organisation reschedules an existing Appointment, the Appointment ID remains the same.
- When your organisation requests that a new Appointment be scheduled, **nbn** will create a new Appointment ID in relation to the new Appointment.
- **nbn** will notify your organisation within 1 hour (either by email or through the **nbn**® Service Portal / B2B Access) when an Appointment is rescheduled between **nbn** and the Contracted End User (regardless of when the rescheduling is agreed).

Who wants to reschedule?	Permitted reason for rescheduling
Your organisation or nbn...	The Appointment Representative has requested your organisation or agreed with nbn to change the Appointment time.
Your organisation...	<p>The Appointment Representative is not in attendance at the designated Premises at the time of the original Appointment, and nbn or the technician informs your organisation that a replacement Appointment is needed.</p> <div data-bbox="368 949 1490 1084" style="background-color: #fff9c4; padding: 5px;">  <p>Important: Not all types of Appointments for nbn® Ethernet require the Appointment Representative to be at the Premises during the Appointment (see section 6.7.1 Selecting Appointments).</p> </div>
Your organisation	The Appointment Representative needs to perform pre work e.g. building access, install a lead in conduit etc.
nbn...	nbn has missed or may miss the Appointment, determines that it cannot complete the Installation or resolve the Trouble Ticket within a single Appointment window or otherwise needs to change the Appointment.
nbn...	nbn determines that it would be dangerous to property, or to the health or safety of any person, for nbn to attend the scheduled Appointment and/or complete the Installation or resolve the Trouble Ticket within the allocated Appointment time period.
nbn...	Circumstances beyond nbn 's reasonable control, including where weather conditions prevent nbn from attending the scheduled Installation or Trouble Ticket Appointment and/or completing the work within the allocated Appointment time period.
nbn...	<p>nbn determines one or more of the following:</p> <ul style="list-style-type: none"> • A Pull Through Activity exception event has occurred • Use of a Temporary Cable is necessary • Cable Rectification is required • Reinstatement testing is required. <p>Note: nbn may also reschedule an Appointment for the purposes of allowing nbn® Personnel to rectify a Service Fault relating to Pull Through Activities, installation of a Temporary Cable or Cable Rectification.</p>
<p>nbn...</p>  <p>SATELLITE</p>	Your organisation has placed an order for nbn ® Ethernet (Satellite) and nbn reschedules the Appointment pursuant to section 6.3.2 New Appointment Process .

Who wants to reschedule?	Permitted reason for rescheduling
End User...	In the event an Appointment Representative has advised nbn that they will not be able to attend the scheduled Appointment date or time, nbn may at its discretion, reschedule the appointment to a future date or time as agreed with the Appointment Representative.

6.4.3 Rescheduling Limitations

Your organisation may only reschedule an Appointment a maximum of three times.

To reschedule an Appointment after exceeding this limit, your organisation must do both of the following things:

- Cancel the current Appointment in accordance with section [6.5 Cancelling Appointments](#)
- Reserve a new Appointment in accordance with section [6.3.2 New Appointment Process](#) through the **nbn**[®] Service Portal or B2B Access.

6.4.4 Rescheduling Notifications

When a reschedule occurs between **nbn** and the Contracted End User, **nbn** will provide notification to your organisation, of the reschedule within 1 hour of the Appointment being rescheduled and will provide, where available, the following information:

- Appointment ID
- Previously scheduled time
- New scheduled time
- Reason for Reschedule (who requested the reschedule)
- Any optional comments.

6.5 Cancelling Appointments



Note: The restrictions to cancelling an Appointment in this section do not apply while an Appointment has a **Reserved** Appointment Status.

Either your organisation or **nbn** may cancel an Appointment where permitted by this document. Upon successful cancellation, **nbn** will update the status of the Appointment to Cancelled through the **nbn**[®] Service Portal or B2B Access.

If your organisation wants to cancel an Appointment, your organisation is required to provide the period of notice before cancelling the Appointment set out in section [6.5.3 Required notice periods for Appointment cancellation by your organisation](#).

See section [6.2.5 Appointment Communication Responsibilities](#) for details of responsibility for communications regarding Appointments.

Either party may cancel an Appointment which has a **Reserved** or **Booked** Appointment Status.

6.5.1 Cancelled Appointment (by your Organisation)

The steps comprising the process for your organisation cancelling an Appointment, and the associated activities **nbn** and your organisation must perform in relation to each step are defined in the table below.

Who	Activity
Your organisation...	<ul style="list-style-type: none"> (Where the Appointment is cancelled with the required notice period) Must cancel the relevant Appointment, referenced by its Appointment ID, through the nbm® Service Portal or B2B Access. (Where your organisation is seeking to cancel the Appointment with less than the required notice period or your organisation is otherwise unable to cancel the relevant Appointment through the nbm® Service Portal or B2B Access) Must contact nbm as detailed in section 6.5.3 Required notice periods for Appointment cancellation by your organisation.
nbm...	Confirms cancellation of the Appointment with your organisation.
Your organisation...	Must confirm with nbm that your organisation will do the following: <ul style="list-style-type: none"> Request a new Appointment through the nbm® Service Portal or B2B Access (if required) and update the associated Access Component order or Trouble Ticket with the new Appointment ID; or Cancel the order or Trouble Ticket that was associated with the old Appointment ID by sending a request to nbm to cancel the order or resolve the Trouble Ticket, through the nbm® Service Portal or B2B Access

6.5.2 Cancelled Appointment (by nbm)

nbm may cancel an Appointment in the following circumstances:

- An Appointment with the Appointment Status of Reserved reaches the end of its Sunset Period (refer to section 6.2.8 Reserved Appointments)
- Either your organisation or **nbm** cancels an order or Trouble Ticket associated with the Appointment
- Where **nbm** determines that a Trouble Ticket Appointment is not required in accordance with section 5.2.3.1 Interactions: Raising a Trouble Ticket with **nbm**
- An Appointment that is scheduled to occur before any Appointment window specified in section 5.2.3.1 Interactions: Raising a Trouble Ticket with **nbm**.
- Your organisation has cancelled a Trouble Ticket in accordance with section 5.2.14.2 Your Organisation initiates cancellation.
- nbm** has received a communication from the Contracted End User or Appointment Representative indicating that a prerequisite for the Appointment will not be met (such as attendance at the Premises or consent to removal of a Power Supply with Battery Backup Unit).

6.5.3 Required notice periods for Appointment cancellation by your organisation

If **nbm** accepts an Appointment cancellation request for an Installation Appointment or for a Trouble Ticket Appointment with less than the following notice periods, your organisation may incur a late cancellation charge in accordance with the [nbm® Ethernet Price List](#).

Network	Required Notice Period for Appointment Cancellation
	For Co-ordinated Appointments or Appointments relating to a Priority Assistance Transaction, at least 24 hours prior to the scheduled Appointment.
	For Appointments relating to a Premises in an Isolated Area or Limited Access Area, and not relating to a Co-ordinated Appointment or Priority Assistance Transaction, at least 48 hours prior to the scheduled Appointment date.
	For all other Appointments, at least 4 hours prior to the scheduled start time.
	For Appointments relating to a Premises in an Isolated Area or Limited Access Area, at least 48 hours prior to the scheduled Appointment date.

Network	Required Notice Period for Appointment Cancellation
	For all other Appointments, at least 1 Business Day prior to the scheduled Appointment date.
	At least 1 Business Day prior to the scheduled Actual Appointment date for a Premises in an Urban Area, Major Rural Area, Minor Rural Area or Remote Area. At least 48 hours prior to the scheduled Actual Appointment date for a Premises in an Isolated Area or Limited Access Area.

6.6 Missed Appointments

Where applicable, when an Appointment Representative is not present at a Premises from the beginning or until the end of an applicable Appointment window (as described by the [nbn® Ethernet Service Levels Schedule](#)), the Appointment is considered to be a Missed Appointment and section [6.6.1 Missed Appointments \(by your Organisation\)](#) below, will apply.



Important: Not all types of Installation or Trouble Tickets for **nbn®** Ethernet require the Appointment Representative to be at the Premises during the Appointment (see section [6.7.1 Selecting Appointments](#)).

6.6.1 Missed Appointments (by your Organisation)

The steps comprising the process in relation to Missed Appointments and the associated activities **nbn** and your organisation must perform in relation to each step, are defined in the table below.

Who	Activity
nbn...	Updates the Appointment Status to " Completed " through the nbn® Service Portal or B2B Access and updates the relevant order or Trouble Ticket Appointment (as applicable) with the following status reason code: 'Customer Not In Attendance'.
Your organisation...	Must arrange a new Appointment in accordance with section 6.3 New Appointments for nbn to attend the designated Premises to complete the required work.
nbn ...	May charge your organisation a Missed Appointment Charge, as specified in the nbn® Ethernet Price List .

6.6.2 Missed Appointments (by nbn)

The steps comprising the process where **nbn** misses, may miss or otherwise needs to re-schedule an Appointment, and the associated activities **nbn** and your organisation must perform in relation to each step, are defined in the table below.

Who	Activity
nbn...	Notifies your organisation as soon as practicable and amends the Appointment Status to Incomplete.
Your organisation...	Must reschedule the Appointment in accordance with section 6.4 Rescheduling Appointments for nbn to attend the relevant Premises to complete the required work.
nbn...	May owe your organisation a Missed Connection Appointment Rebate or Missed Trouble Ticket Appointment Rebate, if specified in the nbn® Service Levels Schedule .

6.7 Installation Specific Processes

6.7.1 Selecting Appointments

Installation activities to be undertaken by **nbn** must be performed by means of an Appointment (except as set out below), reserved through the **nbn**® Service Portal or B2B Access during the order creation process, based upon the following rules:



Important:

- If your organisation places a Connect Order as an Accelerated Connection and there are no Accelerated Appointments available, then your organisation should select a Standard Appointment for that Connect Order. Refer to the [nbn® Ethernet Service Levels Schedule](#) which describes which Service Levels will apply if there are no available Accelerated Connection Appointments.
- Accelerated Appointments are only available for Connect Orders placed as an Accelerated Connection. If your organisation selects an Accelerated Appointment for an order that is not a Connect Order placed as an Accelerated Connection, the Service Levels for Accelerated Orders will not apply to that order.
- If your organisation places an order for an Accelerated Connection at a Service Class 3, Service Class 13, Service Class 24 or Service Class 34 (in respect of which an FTTC-NCD Shortfall does not apply) Premises, it will be treated as an order for a Standard Connection and the relevant Standard Connection Service Levels (including the Service Levels where applicable, specified in section 1.3 of the [nbn® Ethernet Service Level Schedule](#)) will apply to the order.



Important: Your organisation may reserve an After Hours Installation Appointment via the **nbn**® Service Portal or B2B Access.

See the [nbn® Ethernet Price List](#) for details of Charges which apply for an After Hours Installation Appointment.

Note: After Hours Installation Appointments may be available within a Standard Connection service level window for orders with a Standard Connection Service Level or with an Accelerated Connection Service Level based on workforce availability.



Important:

- When making a Co-ordinated Appointment, your organisation must select one of the following:
 - Co-ordinated Appointment (Day)
 - Co-ordinated Appointment (Night)
- Co-ordinated Appointments are not available for, and your organisation must not make Co-ordinated Appointments in respect of, Accelerated Connections or Priority Assistance Connections
- Co-ordinated Appointments are only available in respect of Premises in an Urban Area, and at such other locations as **nbn** may determine at its discretion. Please contact your **nbn**® Relationship Point of Contact to check for availability outside of Urban Areas.

See the [nbn® Ethernet Price List](#) for details of Charges which apply for a Co-ordinated Appointment.



Exception: For an Appointment related to an **nbn**® Ethernet (Satellite) order, your organisation must reserve an Appointment through the **nbn**® Service Portal, but **nbn** will reschedule that Appointment in accordance with section [6.2.5 Appointment Communication Responsibilities](#).

The following table provides details of orders including whether an Appointment is required or Appointment Representative attendance is required in respect of that order:

Service Class	Technology	Order Type	Appointment Required	Appointment Representative attendance required
1	Fibre	Connect Order	Yes	Yes
2	Fibre	Connect Order	Yes	Yes
3	Fibre	Connect Order for installation of an additional or replacement NTD and Power Supply Unit (Standard)	Yes	Yes
3	Fibre	Modify Order for installation of a replacement NTD and Power Supply Unit (Standard)	Yes	Yes
5	Wireless	Connect Order	Yes	Yes
6	Wireless	Modify Order where a W-NTD Upgrade Installation is required	Yes	Yes
6	Wireless	Connect Order for an additional Installation	Yes	Yes
8	Satellite	Connect Order (Includes any of the following: <ul style="list-style-type: none"> No existing satellite service at Premises ABG at Premises NSS at Premises) 	Yes	Yes
9	Satellite	Connect Order	Yes	No
9	Satellite	Modify Order to change any of the following: <ul style="list-style-type: none"> C-TAG; Bandwidth profile; TPEP configuration; CVC; Access Loop Identification mode and Access Loop Identification label; and Modification of AVC bandwidth profile (12/1 25/5 & vice versa). 	Yes	Yes
11	FTTN	Connect Order	Yes	Yes
11	FTTN	Connect Order for an Installation with a Central Splitter Required	Yes	Yes
12	FTTB	Connect Order	Yes	Yes
12	FTTB	Connect Order for an Installation with a Central Splitter Required	Yes	Yes

Service Class	Technology	Order Type	Appointment Required	Appointment Representative attendance required
12	FTTB	Connect Order for an Installation (Installation by your organisation)	No	No*
12	FTTN	Connect Order for an Installation which is not a Transition Order	Yes	Yes
12	FTTN	Connect Order for an Installation with a Central Splitter Required	Yes	Yes
12	FTTN	Connect Order for an Installation where TC-2 Bandwidth Profile ordered	Yes	Yes
12	FTTN	Connect Order for an Installation which is a Transition Order	Yes	No
12	FTTN	Connect Order for an Installation at an Approved Non-Premises Location	Yes	Yes
13	FTTB/FTTN	Connect Order	No	No
13	FTTB/FTTN	Modify Order where a Professional Wiring Service is required	Yes	Yes
21	HFC	Connect Order	Yes	Yes
22	HFC	Connect Order	Yes	Yes
23	HFC	Connect Order or Modify Order for an Installation (by nbn Professional Installation – HFC, including in respect of a Multiple RF Device Premises**)	Yes	Yes
23	HFC	Connect Order or Modify Order for Self-Install Kit – HFC by: <ul style="list-style-type: none"> • RSP Professional Installation – HFC; or • End User Installation – HFC (RSP Dispatched); or • End User Installation – HFC (nbn Dispatched) 	No	No*
24	HFC	Connect Order for an additional NTD and Power Supply (by nbn Professional Installation – HFC, including in respect of a Multiple RF Device Premises**)	Yes	Yes

Service Class	Technology	Order Type	Appointment Required	Appointment Representative attendance required
24	HFC	Connect Order for a missing NTD and Power Supply (by nbn Professional Installation – HFC, including in respect of a Multiple RF Device Premises**)	Yes	Yes
24	HFC	Connect Order for an additional NTD and Power Supply by: <ul style="list-style-type: none"> • RSP Professional Installation – HFC; or • End User Installation – HFC (RSP Dispatched); or • End User Installation – HFC (nbn Dispatched) 	No	No*
24	HFC	Connect Order for a missing NTD and Power Supply by: <ul style="list-style-type: none"> • RSP Professional Installation – HFC; or • End User Installation – HFC (RSP Dispatched); or • End User Installation – HFC (nbn Dispatched) 	No	No*
31	FTTC	Connect Order for a Standard Installation	Yes	Yes
32	FTTC	Connect Order for a Standard Installation at Premises without an active legacy retail service	Yes	Yes
32	FTTC	Connect Order for a Standard Installation at Premises with an active legacy retail service and Self Install Kit – FTTC required	Yes	Yes
33	FTTC	Connect Order for an nbn Professional Installation - FTTC	Yes	Yes
33	FTTC	Connect Order for installation of an FTTC-NCD using a Self-Install Kit – FTTC by: <ul style="list-style-type: none"> • RSP Professional Installation – FTTC; or • End User Installation – FTTC (RSP Dispatched); or • End User Installation – FTTC (nbn Dispatched) 	No	No*
34	FTTC	Connect Order for an installation of a missing FTTC-NCD (by nbn Professional Installation – FTTC)	Yes	Yes

Service Class	Technology	Order Type	Appointment Required	Appointment Representative attendance required
34	FTTC	Connect Order for an installation of a missing FTTC-NCD using a Self-Install Kit – FTTC by: <ul style="list-style-type: none"> RSP Professional Installation – FTTC; or End User Installation – FTTC (RSP Dispatched); or End User Installation – FTTC (nbn Dispatched) 	No	No*
34	FTTC	Modify Order for a Professional Wiring Service	Yes	Yes
3, 6, 9, 13, 24 & 34	All	Disconnect Order	No	No

* **Note:** For these Installation options your organisation is not required to reserve an Installation Appointment as **nbn** is not performing the Installation activities. This means that **nbn** does not require attendance by an Appointment Representative at the Premises. However for Installation by your organisation at Service Class 12 Premises, RSP Professional Installation – HFC or RSP Professional Installation - FTTC, **nbn** expects that your organisation will require the Appointment Representative to be in attendance at the Premises, in order for your organisation to perform the Installation activities inside the Premises.

** **Note:** See section 4.6.6.3 Multiple RF Device Premises for a description of Multiple RF Device Premises.

6.7.2 Order Lead Times

Each Access Component order has an Order Lead Time associated with it.

6.7.2.1 Standard Connection Order Lead Times

The Order Lead Time for any Access Component order requested as a Standard Connection is the greater of the following:

- 4 Business Days
- The Order Lead Time, as specified in the result of the related Site Qualification Enquiry (if any).

6.7.2.2 Accelerated Connection Order Lead Times

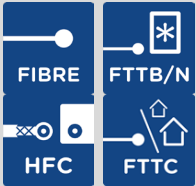

Important: This section applies to Access Component orders for **nbn**[®] Ethernet (Fibre), **nbn**[®] Ethernet (FTTB), **nbn**[®] Ethernet (FTTN), **nbn**[®] Ethernet (FTTC) and **nbn**[®] Ethernet (HFC).

The Order Lead Time for any Access Component order requested as an Accelerated Connection is the greater of the following:

- The Order Lead Time, as specified in the result of the related Site Qualification Enquiry (if any); or
- The following Order Lead Times:

Accelerated Order Location	Order Lead Times
Urban Area	3 Business Days (where the order is received during Operational Hours).
Minor/Major Rural	4 Business Days (where the order is received during Operational Hours).
Remote Area	5 Business Days (where the order is received during Operational Hours).

6.7.3 Availability of Accelerated Appointments

Each month, the number of Accelerated Connection Appointments is limited to 10% of the total number of available Installation Appointments.

Where your organisation seeks to place an order for an Accelerated Connection, it must select an Accelerated Connection Appointment within the relevant Accelerated Connection Service Level. If there are no available Accelerated Connection Appointments within the relevant Accelerated Connection Service Level, your organisation must select an available Standard Connection Appointment.

Refer to the [nbn® Ethernet Service Level Schedule](#) which describes which Service Levels will apply if there are no available Accelerated Connection Appointments.

Note: Your organisation may only order Accelerated Connections if certain conditions apply. Your organisation must not incorrectly order End User Connections as Accelerated Connections if the conditions are not met with respect to an order (and must work collaboratively with **nbn** to avoid such orders).



Important: If your organisation places an order for an Accelerated Connection:

- At a Service Class 3 Premises, Service Class 13 Premises, Service Class 24 Premises or Service Class 34 Premises; or
 - In respect to a Service Class 12 Premises or Service Class 32 Premises if the order is a Transition Order as detailed in section 4.5.2.3 [Transition Orders](#),
- it will be treated as an order for a Standard Connection.

6.8 Trouble Ticket Specific Processes

When your organisation becomes aware of a potential fault or incident affecting an Ordered Product, it must (as soon as reasonably practicable) perform the test and diagnostic tasks specified in the **Test & Diagnostic Checklist** (available on the **nbn**® Service Portal) including submitting a Service Health Summary Enquiry if necessary, to identify whether or not the potential fault or incident is likely to be a Service Fault or Performance Incident.

Note: For Trouble Ticket Appointments, **nbn** is not responsible for any RSP Equipment or End User Equipment; where reasonably practicable, **nbn** will reconnect RSP Equipment or End User Equipment that has been disconnected by **nbn** in the process of completing the necessary field work

6.8.1 Trouble Ticket – Fault Location



This section applies for **nbn**® Ethernet (FTTB) or **nbn**® Ethernet (FTTN).

If, after performing test and diagnostic investigation in accordance with section [5.2.1 Test & Diagnostics](#), including the tasks indicated in the **Test & Diagnostic Checklist** or other steps your organisation is instructed by **nbn** to complete, your organisation identifies the Fault Location as:

Fault Location	Your organisation ...	Appointment Type
Inside the End User Premises	Must schedule a Trouble Ticket Appointment	Appointment
Outside the End User Premises	Is advised to not schedule a Trouble Ticket Appointment unless: <ul style="list-style-type: none"> directed to do so by nbn; the suspected Service Fault is a Priority Assistance Fault or Enhanced Fault; or the suspected Performance Incident is a Priority Assistance Incident. 	Commitment or Appointment



Important: For all Priority Assistance Faults, Enhanced Faults or Priority Assistance Incidents, your organisation must:

- Select the inside End User Premises option in the Trouble Ticket and schedule a Trouble Ticket Appointment, irrespective of the Fault Location; and
- Must indicate the Fault Location in the 'Description of the problem' section of the Trouble Ticket.

Refer to section [5.2.3 Raising, Validating and Resolving a Trouble Ticket](#) for details regarding raising a Trouble Ticket for Priority Assistance Faults, Enhanced Faults or Priority Assistance Incidents.

The following table describes the interactions between your organisation and **nbn** in circumstances where no Trouble Ticket Appointment is required (i.e. the Fault location is outside the End User Premises), or **nbn** cancels a Trouble Ticket Appointment and intends to attend the Fault Location:

Responsibility	Activity
nbn...	<ul style="list-style-type: none"> Must notify your organisation of the Target Commitment Date; or May, if no Trouble Ticket Appointment has been Reserved, request that your organisation reserve a Trouble Ticket Appointment <i>(For Trouble Tickets that do not have Appointments, if the Trouble Ticket has not been closed by the Target Commitment Date in accordance with section 5.2.13.2 Interactions: Closure of a Resolved Trouble Ticket)</i> Will revise the Target Commitment Date and send your organisation a notification.
Your organisation...	<p>Must, promptly after receiving notice from nbn of a Target Commitment Date under this section 6.8.1 Trouble Ticket – Fault Location, notify the Contracted End User:</p> <ul style="list-style-type: none"> Of the Target Commitment Date; That no person needs to be present at the Premises at the time of the assurance activity; That the Contracted End User may experience an Outage prior to the time the Trouble Ticket Status is changed to Resolved that affects (or is likely to affect) the End User's access to emergency services. <p>Must, promptly after receiving a Resolved Notification from nbn under section 5.2.13.2 Interactions: Closure of a Resolved Trouble Ticket, notify the Contracted End User to confirm that the Service Fault has been resolved.</p>

Module 7: Event Management



7.1 In this Module

This module is concerned with events or circumstances that may impact multiple areas such as the Assurance and Activation of Ordered Products. It applies if there is a risk of a service or network impact or if **nbn** is the Affected Party in a Force Majeure Event.

A ROSNI will not always lead to a Force Majeure Event. A Force Majeure Event will not always be preceded by a ROSNI.

7.2 Risk of Service or Network Impact (ROSNI)

7.2.1 ROSNI

nbn will use reasonable endeavours to issue a ROSNI if **nbn** determines that there is a risk of a substantially adverse impact affecting ordered products or the **nbn**[®] Network.

A ROSNI will list the geographic areas that **nbn** considers are at risk as far as possible. In the case of the Satellite Network, the potentially affected States or Territories will be listed.

The ROSNI will be issued via the **nbn**[®] Service Portal and B2B Access.

7.2.2 ROSNI Updates

nbn will use reasonable endeavours to update a ROSNI if there are meaningful or substantial changes to the information provided in a previously issued ROSNI (for example, to update ROSNI details to include new areas affected by a growing fire hazard).

7.2.3 ROSNI Closure

nbn will close a ROSNI via the **nbn**[®] Service Portal and B2B Access once **nbn** determines that ordered products and the **nbn**[®] Network are no longer at risk.

7.3 Force Majeure

Force Majeure Event has the meaning given to that term in the [Dictionary](#), which is extracted below for ease of reference only. If there is any inconsistency between the [Dictionary](#) and the extract below, the [Dictionary](#) will prevail to the extent of any inconsistency.

Definition of Force Majeure Event from the WBA Dictionary

Force Majeure Event means any event or circumstance that:

- (a) is not within the reasonable control of a person (the **Affected Party**) or any of its Related Bodies Corporate or any of their Personnel;
- (b) the Affected Party or any of its Related Bodies Corporate or any of their Personnel is not reasonably able to prevent or overcome by the exercise of reasonable care, such as by having in place or implementing a disaster recovery plan or complying with an **nbn**[®] Power Resiliency Policy; and
- (c) causes the Affected Party to fail to perform any of its obligations under this Agreement,

but does not include:

- (d) any event or circumstance that arises as a result of any lack of funds for any reason or any other inability to pay; or
- (e) any event or circumstance that arises as a result of any negligent act or omission of the Affected Party.

Examples of Force Majeure Events that may affect **nbn** may include flooding, earthquake or loss of a technical facility due to a fire.

nbn will use Infrastructure Restoration Trouble Tickets to manage the operational details of a Force Majeure Event (refer to section [5.4.1 Infrastructure Restoration Trouble Tickets](#)).

7.3.1 Force Majeure Event Notice

nbn will use reasonable endeavours to provide a Force Majeure Event Notice to your organisation within 3 Business Days of a Force Majeure Event.

The Force Majeure Event Notice will contain relevant information relating to that Force Majeure Event which will include the following information, where known:

- Event start date
- Event description
- How the event impacts **nbn** e.g. a link to a Bureau of Meteorology notice where relevant
- Approximate number of Premises affected
- Geographical information for areas impacted (see below)
- Any related reference (i.e. ROSNI/FME) - if applicable
- Known Ordered Products and Product types impacted
- Estimated end date.

If **nbn** is unable to provide all the details listed above, **nbn** will issue an update as soon as reasonably practicable after the information becomes available to **nbn**.

The Force Majeure Event Notice may also contain other information relevant to the Force Majeure Event.

What kind of geographical information will nbn provide to your organisation?

nbn will provide the district, local government area, suburb or town, network boundaries or such other relevant geographical information related to the Force Majeure Event, to the extent such information is known to **nbn** at the time of the Force Majeure Event.

7.3.2 Force Majeure Event Updates

nbn will provide your organisation an update if there is a meaningful or substantial change to information included in a Force Majeure Event Notice as soon as reasonably practicable after **nbn** becomes aware of the change.

7.3.3 Force Majeure Event Closure

nbn will, in accordance with clause [E6.2 of the Head Terms](#), provide a Force Majeure Event closure notice to your organisation once the Force Majeure Event is closed.

Module 8: Billing and Payments



8.1 In This Module

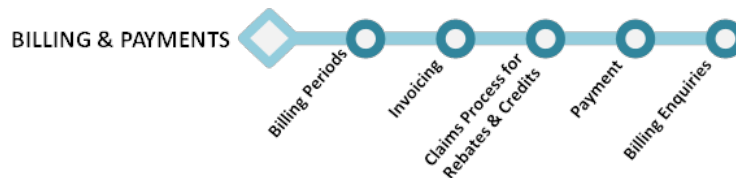

This module describes the billing processes and requirements that apply to **nbn** and your organisation in connection with the supply of Products.

8.2 About Billing

nbn generates monthly invoices for billing. Invoices are issued electronically via the **nbn**[®] Service Portal or B2B Access. Your organisation's designated contact, as specified in the **Contact Matrix**, is notified by email when invoices are issued. Invoices contain details of the Charges and other amounts payable by your organisation under the [WBA](#) together with deductions for items such as Discounts, Credits, Rebates and Waivers.

nbn may provide detailed charge information either daily or monthly.

nbn may make Credits or Rebates available to your organisation from time to time in accordance with the [WBA](#). This module describes how to claim those Credits or Rebates which are not automatically provided to your organisation.

This module also sets out the procedure which must be followed if your organisation wishes to raise a Billing Enquiry.

8.3 Billing Periods

Each Billing Period is a period of one month starting on the first day of each calendar month.

8.4 Invoicing

8.4.1 Forms of Invoice

For each Billing Period, **nbn** will make each of the following forms of invoice available to your organisation (where applicable):

- Tax Invoice
- Billing Invoice File (BIF)
- Billing Event File (BEF)
- Billing Adjustment File (BAF).

These are described further in sections [8.4.1.2 Tax Invoice](#) to [8.4.1.5 Billing Adjustment File \(BAF\)](#)

8.4.1.1 Notification of changes to the form of invoices

nbn may change the format, layout, presentation or data contained within the different forms of invoices by providing at least 30 Business Days prior notice.

8.4.1.2 Tax Invoice

Tax Invoice	
Description	The monthly Tax Invoice issued by nbn that summarises the amounts payable by your organisation for the relevant Billing Period

Tax Invoice	
Format	Portable Document Format (PDF)
Available from	nbn [®] Service Portal or B2B Access
Frequency	Monthly, according to the Billing Period
Availability	Available for each Billing Period
Notification of availability via	Email

Samples of the current tax invoice forms are set out in the ***nbn**[®] Operations User Guide*.

8.4.1.3 Billing Invoice File (BIF)

Billing Invoice File (BIF)	
Description	The machine-readable version of a Tax Invoice; contains a summary of the amounts payable by your organisation for the relevant Billing Period. The BIF does not include any of the information provided within the Tax Invoice's Statement Summary section.
Format	XML
Available from	nbn [®] Service Portal or B2B Access
Frequency	Monthly, according to the Billing Period
Availability	Available for each Billing Period
Notification of availability via	Email
Contents	<ul style="list-style-type: none"> • nbn company information • Total amount due and GST payable • Due Date and payment options • Your organisation's address information • Summary of spend by Product • Billing Event Files distributed since last invoice • Other Charges and credits.

Refer to the ***B2B Gateway Developers Guide – Billing*** document, for a detailed description and examination of **nbn**'s XML messaging structures for BIFs.

8.4.1.4 Billing Event File (BEF)

Billing Event File (BEF)	
Description	A machine-readable file that contains an itemised list of amounts payable by your organisation for the relevant Billing Period. There are two types of Charges: <ul style="list-style-type: none"> • Recurring • Non-recurring or once off.
Format	XML
Available from	nbn [®] Service Portal or B2B Access
Frequency	Your organisation can select the BEF creation frequency at either of the following times: <ul style="list-style-type: none"> • During On-boarding: During the creation of your organisation's RSP Billing Account (see section 2.2.1.2 Create an RSP Billing Account)

Billing Event File (BEF)	
	<ul style="list-style-type: none"> Any other time: By submitting a Billing Enquiry (see section 8.8.2 Raising a Billing Enquiry) at least 10 Business Days prior to the date on which your organisation requires that the change take effect. <p>If your organisation does not select the BEF creation frequency during the creation of your organisation's RSP Billing Account or at any other time as set out above, then the BEF will be created monthly, in accordance with the Billing Period.</p>
Availability	Available for each Billing Period
Notification of availability via	Email
Contents	<p>The items specified in clause B2.2(a) of the Head Terms, including the following:</p> <ul style="list-style-type: none"> Charges for each Ordered Product acquired by your organisation in accordance with each Price List and each Discounts, Credits and Rebates Annexure This includes monthly recurring charges for NNI, CVC, AVC, UNI-D and UNI-V. All such charges are categorised by Product Instance ID Ancillary charges incurred by your organisation in accordance with each Price List and each Discounts, Credits and Rebates Annexure. This includes Charges for service installation, service modification and service management Any other once off Charges, as specified in any Price List and Discounts, Credits and Rebates Annexure Rebates or Credits that are processed and applied in the current Billing Period. This may include Credits arising from settlements of Billing Disputes (see clause B5 of the Head Terms) Rebates or Credits provided in accordance with section 8.5 Claims Process for Rebates and Credits Any pro rata adjustments applicable in accordance with clause B1.4 of the Head Terms and Discounts, Credits and Rebates Annexure. These include pro-rated Charges for activation, modification or disconnection of an Ordered Product. Pro-rating is based on the number of days the Ordered Product was supplied to your organisation by nbn during the applicable Billing Period.

Refer to the **B2B Gateway Developers Guide – Billing** document, for a detailed description and examination of **nbn** XML messaging structures for BEF's.

8.4.1.5 Billing Adjustment File (BAF)

Billing Adjustment File (BAF)	
Description	<p>A machine-readable file that contains Rebates and/or settlements of disputes for a previous Billing Period.</p> <p>Issued when an adjustment or settlement is performed on a Charge or Rebate invoiced in a previous Billing Period.</p>
Format	XML
Available from	nbn ® Service Portal or B2B Access
Frequency	<p>Based on frequency of BEF:</p> <ul style="list-style-type: none"> Monthly, according to the Billing Period: a BAF will only be issued when a relevant transaction has been generated by nbn during the Billing Period and will include all relevant transactions performed during the Billing Period Daily: BAF issued daily whenever a relevant transaction has been generated by nbn on the relevant day.

Billing Adjustment File (BAF)	
Availability	Available where adjustments are made to an invoice from a previous Billing Period
Notification of availability via	Email
Contents	Rebates relating to a previously issued invoice

Refer to the **B2B Gateway Developers Guide – Billing** document, for a detailed description and examination of **nbn**'s XML messaging structures for BAFs.

8.4.1.6 Additional Information on BIF, BEF and BAF Invoice Types

Additional information is contained in the **B2B Gateway Developers Guide – Billing** document. Your organisation may submit a Billing Enquiry to request a copy; see section [8.8 Billing Enquiries](#).

8.4.2 Late Issuing of Forms of Invoice

If **nbn** is unable to issue a form of invoice within 10 Business Days after the start of a Billing Period, **nbn** will endeavour to notify your organisation by email of the delay and the revised date by which **nbn** will issue that form of invoice to your organisation.



Important: If **nbn** is delayed in issuing a form of invoice, your organisation must still pay the invoice by its Due Date. However, the Due Date for that invoice will be based on the date that **nbn** issues the form of invoice to your organisation.

8.4.2.1 Failure to Receive a Form of Invoice

Your organisation must notify **nbn** if it does not receive a form of invoice by the later of the following dates:

- The date specified in clause B2.2(b) of the [Head Terms](#)
- The revised date notified by **nbn** to your organisation under section [8.4.2 Late Issuing of Forms of Invoice](#) above.

If your organisation is required to notify **nbn** under this section, then it must provide such notice within 15 Business Days from the later of the dates referred to above, by submitting a Billing Enquiry stating that your organisation has not received the form of invoice.

For details of submitting a Billing Enquiry, and **nbn**'s obligations in fulfilling a request, see section [8.8 Billing Enquiries](#).

8.5 Claims Process for Rebates and Credits

Available rebates and credits include:

- 50 Kbps CVC Credit
- CSG Compensation
- Connection Rebate
- Missed Connection Appointment Rebate
- Enhanced Fault Rectification Rebate
- First Battery Credit
- Satellite Test Service
- Service Fault Rebate
- Co-ordinated Appointment Rebate
- Missed Trouble Ticket Appointment Rebate

- Failed Connection Rebate
- PIR Objective Rebate
- FTTB/N/C Connection Performance Rebate
- Wireless Speed Performance Rebate
- Any other Credits or Rebates notified in accordance with the [WBA](#).

8.5.1 Credits and Rebates

Under the [WBA](#), **nbn** may provide Credits and/or Rebates to your organisation by the following methods:

Method	Action Required by Your Organisation
nbn applies the relevant Credits or Rebates (that nbn determines are applicable in accordance with the WBA) to your organisation's invoices or RSP Billing Account for the relevant Billing Period or later where permitted under this section 7.5.	No action required.
nbn requires your organisation to submit a claim before nbn will provide the related Credit or Rebate to your organisation.	<ol style="list-style-type: none"> 1. Your organisation must submit a Billing Enquiry to request a copy of the Credit/Rebate Claim Form. See section 8.8 Billing Enquiries. 2. Your organisation must submit the relevant claim, using the Credit/Rebate Claim Form. See section 8.5.1.1 Submitting a Credit/Rebate claim.

8.5.1.1 Submitting a Credit/Rebate claim

If your organisation wishes to lodge a Credit/Rebate claim, your organisation must ensure that its Authorised Contact completes a Credit/Rebate Claim Form and either:

- sends it to the **nbn**[®] Billing Contact, using the email address specified in the **Contact Matrix**; or
- submits it via the **nbn**[®] RSP Support Centre.

8.5.1.2 Acknowledging a Credit/Rebate claim

nbn will endeavour to acknowledge receipt of each **Credit/Rebate Claim Form** within 2 Business Days.

nbn will acknowledge a **Credit/Rebate Claim Form** by contacting your organisation's Authorised Contact or the person specified as your organisation's nominated contact person in the **Credit/Rebate Claim Form**, as applicable.

8.5.1.3 Processing a Credit/Rebate claim

nbn will only accept a **Credit/Rebate Claim Form** if it is submitted in accordance with the [WBA](#). After receiving a correctly submitted **Credit/Rebate Claim Form**, **nbn** will determine the amount of any Credit or Rebate that **nbn** will pay (if any) in accordance with the [WBA](#).

nbn will process accepted Credit/Rebate Claim Forms and provide your organisation with any applicable Credit or Rebate that **nbn** determines is payable, in one of the following ways:

- Applied to your organisation's RSP Billing Account
- In the invoice for the relevant Billing Period
- By any other means specified in the [WBA](#) for provision of that Credit or Rebate.

8.5.1.4 Rejecting Claims

nbn may reject a **Credit/Rebate Claim Form** in either of the following circumstances:

- The claim does not comply with the [WBA](#)

- **nbn** does not agree that your organisation is eligible for the Credit or Rebate which it has claimed.

What if your organisation disagrees with the amount of any Credit or Rebate applied to an invoice or with nbn's decision to reject a Credit/Rebate Claim Form?

Your organisation may raise a Billing Dispute (see clause B5 of the [Head Terms](#)).

8.5.1.5 Automatic payment of Commercial Rebates

nbn will apply Connection Rebates, Failed Connection Rebates, Missed Connection Appointment Rebates, Service Fault Rebates, Missed Trouble Ticket Appointment Rebates, PIR Objective Rebates, FTTB/N/C Connection Performance Rebates, Enhanced Fault Rectification Rebates and Wireless Speed Performance Rebates (that are applicable in accordance with the [WBA](#)) to your organisation's RSP Billing Account by the time **nbn** issues an invoice to your organisation for the first Billing Period that starts at least 15 Business Days after the later of:

- the conditions for payment of the Commercial Rebate first being met
- the end of the month to which the relevant Commercial Rebate relates.

Note:

Your organisation may raise a Billing Enquiry or Billing Dispute in respect of any Commercial Rebate it considers to be payable under this section [8.5.1.5](#).

8.6 Credits for Satellite Test Services

To ensure that your organisation is not charged for any Charges waived by **nbn** under section 34 of the [nbn[®] Ethernet Product Terms](#) in respect of any Satellite Test Service, your organisation must provide your **nbn[®]** Operational Point of Contact with full particulars, including the AVC Service ID and associated Product Instance ID, of each such Satellite Test Service.

Based on the information supplied by your organisation to **nbn**, **nbn** will apply credits to any invoice containing Charges in respect of a Satellite Test Service which have been waived under section 34 of the [nbn[®] Ethernet Product Terms](#).

8.7 Payment

8.7.1 **nbn[®]** Bank Account

Each **nbn[®]** invoice specifies the details of the **nbn[®]** bank account to which payments must be made.

Note: If **nbn** changes its nominated banking account, it will provide at least 5 Business Days prior written notice to your organisation.

8.7.2 Remittance Advice

For more information, see clause B3 of the [Head Terms](#).

8.7.2.1 Remittance Advice Content

The remittance advice provided by your organisation must, at a minimum, include all of the following information:

- Invoice number to which the payment relates
- Value of the payment

- (If applicable) Value of any disputed amount withheld in accordance with clause B3.1(b) of the [Head Terms](#)
- Payment date
- Financial institution undertaking the transfer
- (As assigned by the financial institution) Funds transfer reference number.

8.7.2.2 Sending the Remittance Advice

Your organisation must send the remittance advice to the email address specified by **nbn** in the invoice.

8.7.3 Record of Payments in Next Invoice

See also: clause B3.2 of the [Head Terms](#).

Each invoice issued by **nbn** to your organisation includes a record of the last payment made by your organisation to **nbn** that has been processed by **nbn** (if any).

8.7.3.1 Incorrect Record of Prior Payments in an Invoice

To notify **nbn** that your organisation considers that a prior payment has not been properly recorded in the subsequent invoice, your organisation must submit a Billing Enquiry to **nbn**.

See section [8.8 Billing Enquiries](#).

8.8 Billing Enquiries and Disputes

8.8.1 Authorised Contacts

The only people who may raise a Billing Enquiry or Billing Dispute on behalf of your organisation, are those appointed as Authorised Contacts during the creation of your organisation's RSP Billing Account or as updated from time to time in accordance with section [8.8.1.1 Changing Authorised Contacts](#).

See section [2.2.1.2 Create an RSP Billing Account](#).

8.8.1.1 Changing Authorised Contacts

To change any of your organisation's Authorised Contacts, your organisation must raise a Billing Enquiry notifying **nbn** of the change no later than 10 Business Days before your organisation requires the change to take effect. Any change will be included in the **Contact Matrix**.

8.8.2 Raising a Billing Enquiry

8.8.2.1 When to Raise Billing Enquiries

Your organisation's Authorised Contact may raise a Billing Enquiry to perform any of the following tasks:

- Raise simple or general enquiries about invoices, billing or Charges
- Change the email address or postal address to which **nbn** sends invoices and notification emails
- Request invoice detail records
- Notify **nbn** of a failure to receive an invoice
- Raise a query about a prior payment that has not been properly recorded in the following invoice
- Obtain a copy of the **Billing Dispute Form**
- Obtain a copy of the **Credit/Rebate Claim Form**
- Obtain a copy of the **B2B Gateway Developers Guide – Billing**
- Ask any other questions, raise any other concerns or seek clarification, in relation to any aspects of billing or the processes set out in this module.



Important: Any enquiry that may subsequently result in an adjustment to an invoice because of an error in that invoice must be raised as a Billing Dispute. See clause B5 of the [Head Terms](#).

8.8.2.2 How to Raise a Billing Enquiry

To raise a Billing Enquiry, your organisation's Authorised Contact can contact the [nbn[®] Billing Team via email](#) or telephone using the contact details specified in the **Contact Matrix**, or submit a Billing Enquiry via the **nbn[®] RSP Support Centre**.

The **nbn[®] Billing Team** is available from 9:00 am to 5:00 pm (AET) during Business Days.

Refer to the **Contact Matrix** for specific contact details, unless otherwise advised by **nbn**.

8.8.2.3 Responding to Billing Enquiries

nbn will endeavour to acknowledge receipt of each Billing Enquiry within 2 Business Days after it has been raised in accordance with section 8.8.2.2 [How to Raise a Billing Enquiry](#) above, by notifying your organisation's Authorised Contact.

The **nbn[®] Billing Team** or the **nbn[®] RSP Support Centre** (as the case may be) will endeavour to respond to the Billing Enquiry within 10 Business Days of your organisation raising the Billing Enquiry in accordance with section 8.8.2.2 [How to Raise a Billing Enquiry](#) above.

If the **nbn[®] Billing Team** or the **nbn[®] RSP Support Centre** (as the case may be) considers that it will not be able to respond within this period, it will endeavour to notify your organisation of a revised timeframe for providing a response.

8.8.2.4 Escalating Billing Enquiries

If your organisation is not reasonably satisfied with the resolution of a Billing Enquiry, and wishes to escalate the Billing Enquiry, your organisation (via its Authorised Contact) must contact the **nbn[®] Relationship Point of Contact** to seek to resolve the issue.

8.8.3 Submitting a Billing Dispute Form

Subject to clause B5 of the Head Terms, your organisation's Authorised Contact may raise a Billing Dispute by completing a Billing Dispute Form and either:

- sending it to the **nbn[®] Billing Contact** using the email address set out in the **Contact Matrix**; or
- submitting it via the **nbn[®] RSP Support Centre**.

8.8.4 Changing the Notification Email Address for Billing Matters

To change the email address to which **nbn** sends your organisation notification emails for billing matters, your organisation must submit a Billing Enquiry notifying **nbn** of the change, no later than 10 Business Days before the change is requested to take effect. Any change will be included in the **Contact Matrix**.

Module 9: Operational Governance



9.1 In This Module

This module describes the Governance Processes which provide a framework for engagement between **nbn** and your organisation in relation to **nbn**'s operational performance.

9.2 Operational Governance

9.2.1 Governance Processes

In each Governance Period, **nbn** and your organisation will:

- Prepare and exchange Governance Reports (other than Performance Reports) at least 5 Business Days before the Governance Meeting;
- Conduct Governance Meetings; and
- Identify Governance Action Items.

Governance Processes may evolve during the Term to accommodate the learnings and experiences of the parties, and may apply differently to different Products to take account of their differing characteristics.

nbn and your organisation will work together in good faith to apply the Governance Processes effectively and efficiently in respect of each Product.

Your organisation may request assistance from **nbn** regarding the Transaction Manager through the Governance Meeting. Such requests for assistance may include requests to adjust any Quota (See the Service Description for the [nbn® Platform Interfacing Service](#) for more information) or to deactivate the Transaction Manager (so that it only notifies your organisation when the Transaction Quota is exceeded (without deprioritising any subsequent Monitored Transactions) (See the Service Description for the [nbn® Platform Interfacing Service](#) for more information).

9.2.2 Scope

Unless otherwise agreed by the parties, Governance Processes do not apply in respect of:

- Billing and payment;
- Network rollout and network planning;
- General network performance that does not have a specific impact on the supply of Products to your organisation;
- Marketing;
- Commercial matters and the terms of the Agreement; and
- **nbn**'s operational performance in respect of Other RSPs.

9.2.3 Governance Reports

Each party must make available a copy of its Governance Report to the other party using the method notified by **nbn** from time to time.

9.2.3.1 Independent Evaluation of Measurement and Monitoring

Each [Service Levels Schedule](#) sets out the steps that **nbn** will take to evaluate the accuracy of its measurement and monitoring tools and in the preparation of Performance Reports. Performance Reports are a subset of Governance Reports.

9.2.3.2 Governance Report Enquiry

Your organisation can make enquiries in relation to the accuracy of information and/or data contained in a Governance Report at any time within 6 months after the end of the Governance Period to which the Governance Report relates.

Exception: Your organisation cannot make enquiries of this kind in relation to Performance Reports.

Note: Each of the [Service Levels Schedules](#) describes how your organisation can make a Data Enquiry in relation to Performance Reports, and the timeframes in which **nbn** will endeavour to respond to Data Enquiries.

To make a Governance Report enquiry, your organisation must email its **nbn**[®] Operational Point of Contact, and include all of the following information:

- The information requested by your organisation (including the applicable date/time range)
- Any additional information necessary for **nbn** to understand the scope of the relevant enquiry.

nbn will endeavour to provide a response to each enquiry raised by your organisation (including, where appropriate, a resolution or a proposal for a resolution) within 10 Business Days after **nbn** receives the enquiry.

What if nbn cannot respond within this time?

nbn will provide your organisation with a revised delivery estimate.

Is nbn obliged to provide the requested information?

No.

nbn assesses each Governance Report enquiry on a case-by-case basis. As part of its assessment, **nbn** will consider the current capability and availability of **nbn**[®] systems and resources to fulfil the request.

9.2.4 Governance Meetings

Unless **nbn** and your organisation agree otherwise, **nbn** and your organisation will alternate the hosting and chairing of Governance Meetings, starting with **nbn**.

In advance of each Governance Meeting, the party hosting the meeting must prepare and circulate the proposed agenda for the meeting and attach copies of each party's Governance Reports for the relevant Governance Period.

9.2.4.1 Purpose

The Governance Meetings are intended to enable **nbn**'s and your organisation's representatives to, unless otherwise agreed between the parties, do each of the following:

- Review and discuss each party's relevant Governance Reports, including any discrepancies that are apparent between such Governance Reports
- Review and discuss the status of open Governance Action Items that were set or discussed in previous Governance Meetings (if any)
- Set new Governance Action Items for the purposes of improving **nbn**'s operational performance during the Term
- Discuss other issues in relation to **nbn**'s operational performance under the [WBA](#) that either **nbn** or your organisation wishes to discuss.

9.2.4.2 Attendance

Your organisation must ensure that each Governance Meeting is attended by suitably experienced and senior Personnel of your organisation who are appropriately briefed and prepared to discuss the agenda items for that Governance Meeting.

Note: Appropriate attendees may include the Relationship Point of Contact and Operational Point of Contact.

nbn and your organisation must use reasonable endeavours to keep the number of attendees at Governance Meetings to a minimum.

Whenever reasonably practicable, Governance Meetings should be held in person.

When attendance in person is not reasonably practicable, Governance Meetings can be held by video or telephone conference, provided that all participants can simultaneously hear each other throughout the meeting.

9.2.4.3 Conduct

nbn and your organisation must use reasonable endeavours to conduct each Governance Meeting efficiently.

9.2.4.4 Minutes

Unless **nbn** and your organisation agree otherwise, **nbn** will record the minutes of each Governance Meeting and provide a copy of those minutes to your organisation as soon as reasonably practicable after the Governance Meeting.

Your organisation will have an opportunity to review the minutes. If your organisation believes that the minutes are not accurate then it may request that **nbn** amend the minutes. **nbn** will, acting reasonably, consider any such request and determine in its sole discretion whether the minutes need to be amended. If **nbn** determines that the minutes need to be amended, then **nbn** will provide a copy of the amended minutes to your organisation as soon as reasonably practicable.

9.2.5 Governance Action Items

The purpose of Governance Meetings is to help **nbn** and your organisation improve their operational performance.

During each Governance Meeting, **nbn** and your organisation will collaborate to identify and set new Governance Action Items. Each Governance Action Item must serve to help **nbn** improve its operational performance.

Any proposed Governance Action Items should be reasonable in the circumstances, and take into account all associated costs and benefits.

If **nbn**, acting reasonably, does not agree that a certain action should be a Governance Action Item, then it will work with your organisation to attempt to identify an alternative forum to consider the relevant action item.

9.2.5.1 Performance Improvement Groups

nbn and your organisation may assign responsibility for the resolution of one or more Governance Action Items to a small group comprised of an equal number of representatives from **nbn** and your organisation.

Each of the groups described above must report back at subsequent Governance Meetings until **nbn** and your organisation agree that the relevant Governance Action Item(s) have been addressed in a mutually satisfactory manner.

9.2.6 Requests for ad hoc Reports

Each party may request that the other party provides it with one or more ad hoc reports.

The requesting party must email its ad hoc report request to the other party's Operational Point of Contact, and must include all of the following details:

- Details of the information and data requested, including the start and end dates for such information and data
- The date on which the requesting party would like the report to be provided
- Any other information that is necessary for the other party to understand the parameters of the report being requested.

The party who receives an ad hoc report request will assess it on a case by case basis and may (but is not required to) provide such requested reports to the requesting party.

As part of its consideration, the party receiving an ad hoc report request will consider the capability and availability of its systems and resources in assessing whether or not to provide the requested report.

9.3 Operational Reporting

nbn will make available to your organisation, in addition to the Performance Reports provided to your organisation under the **nbn**[®] Ethernet Service Levels Schedule, the Operational Reports in accordance with this section 9.3.

nbn will follow the process set out in clause F4.7(a) of the Head Terms , including first consulting in accordance with clause F4.10 of the Head Terms, when making any material changes to any Operational Report with respect to structure, content, delivery method or timing.

9.3.1 Supplementary Service Level Reports

9.3.1.1 Subject of Supplementary Service Level Reports

Each Supplementary Service Level Report will:

- correspond with a Performance Report provided under the **nbn**[®] Ethernet Service Levels Schedule; and
- contain details regarding **nbn**'s performance of Activities at a greater level of granularity than the corresponding Performance Report.

9.3.1.2 Content of Supplementary Service Level Reports

Each Supplementary Service Level Report will contain the following content for the following Activities performed in relation to **nbn**[®] Ethernet:

Activity	Reporting
<ul style="list-style-type: none"> • All Activities included in the Performance Reports provided to your organisation under the nbn[®] Ethernet Service Levels Schedule 	<p><u>Aggregated Report</u></p> <ul style="list-style-type: none"> • nbn's performance against Service Levels or Performance Objectives for the Activity, measured in the aggregate, for all retail service providers, and broken down by location, Service Class and nbn[®] Ethernet access technology, (except to the extent that nbn considers, acting reasonably, that the confidential information of one or more of nbn's retail service providers could be readily apparent from such a report)
<ul style="list-style-type: none"> • End User Connections • End User Fault rectifications • Access Component Modifications • Access Component Disconnections 	<p><u>Stop the Clock Report</u></p> <ul style="list-style-type: none"> • The start time and end time for each event within the lifecycle of an Activity at which nbn starts or stops measuring performance of the Activity against the relevant Service Level.

Activity	Reporting
<ul style="list-style-type: none"> • End User Connections • Actual Appointments • End User Fault rectifications • Priority Assistance Fault rectifications • Enhanced Fault rectifications • Actual Trouble Ticket Appointments • Access Component Modifications • Access Component Disconnections 	<p><u>WBA Performance Reporting Line Level data</u></p> <ul style="list-style-type: none"> • In respect of each Activity, whether nbn met or missed the applicable Service Level. • In respect of each Activity, whether the measurement of a Service Level was suspended or otherwise subject to an exclusion in accordance with this Agreement. • For End User Connections and End User Fault rectifications: <ul style="list-style-type: none"> • the total number of Operational Hours taken by nbn to perform the Activity; • the total number of Operational Hours measured by nbn for the purpose of nbn's compliance with the applicable Service Level (i.e. excluding any time during which the measurement of the applicable Service Level was suspended or otherwise subject to an exclusion in accordance with this Agreement); and • where applicable, the number of Business Days by which nbn exceeded the relevant Service Level.

9.3.1.3 Delivery of Supplementary Service Level Reports

nbn will make each Supplementary Service Level Report available to your organisation through the **nbn**[®] RSP Support Centre.

9.3.1.4 Timing of Supplementary Service Level Reports

nbn will make each Supplementary Service Level Report available to your organisation at the same time that **nbn** makes available the corresponding Performance Report.

In addition, **nbn** will make provisional WBA Performance Reporting Line Level data available to your organisation on a weekly basis. The data contained in these provisional reports is in draft form and may be subject to change as **nbn** reviews and confirms its accuracy.

9.3.2 Wireless performance reporting



Important: This section applies to **nbn**[®] Ethernet (Wireless)

9.3.2.1 Subject of wireless performance reporting

nbn will make available Wireless Performance Reports to your organisation regarding the performance of cells and transmission backhaul links forming part of the Wireless Network.

9.3.2.2 Content of wireless performance reporting

Wireless Performance Reports include:

- the LOC ID Report;
- the Throughput Report; and
- Priority Forecast Upgrade Cell Report.

The content of each section is described below:

LOC ID Report

The LOC ID Report will contain:

- the following information for each Wireless Network cell which, in the previous week, was a Priority Upgrade Cell (Reported Upgrade Cell):
 - a list of each Premises at which **nbn** is supplying **nbn**[®] Ethernet (Wireless) to your organisation which was connected to a Reported Upgrade Cell in the previous week, identified by AVC and **nbn**[®] Location ID;
 - a forecast of the month or months in which **nbn** plans an Upgrade for each Reported Upgrade Cell; and
 - any action that may be required of your organisation or any Downstream Service Providers or End Users in relation to any planned Upgrades; and
- the following information in respect of each Wireless Network cell which, in the previous week, was connected to a Point of Interconnection via a Transmission Backhaul Link which was a Priority Upgrade Link (Reported Upgrade Link):
 - a list of each Premises at which **nbn** is supplying **nbn**[®] Ethernet (Wireless) to your organisation which was connected to a Reported Upgrade Link in the previous week, identified by AVC and **nbn**[®] Location ID;
 - a forecast of the month or months in which **nbn** plans an Upgrade for each Reported Upgrade Link; and
 - any action that may be required of your organisation or any Downstream Service Providers or End Users in relation to any planned Upgrades.

Throughput Report

The Throughput Report will contain:

- a list of each Wireless Network cell specifying whether that cell, in the previous week:
 - had an Average Downlink Throughput of:
 - less than 3 Mbps;
 - 3 Mbps to less than 6 Mbps; or
 - 6 Mbps or above; and
 - was connected via a Priority Upgrade Link; or
- for each Wireless Network cell, if available, the month or months in which **nbn** plans an Upgrade for:
 - the Wireless Network cell, if it was a Priority Upgrade Cell in the previous week; and
 - the Transmission Backhaul Link, if it was a Priority Upgrade Link in the previous week.

Priority Forecast Upgrade Cell Report

The Priority Forecast Upgrade Cell Report will contain a forecast of the month during the next six months (if any) in which each Wireless Network cell is expected to become a Priority Upgrade Cell.

9.3.2.3 Delivery of wireless performance reporting

nbn will make each Wireless Performance Report available to your organisation via B2B Access using APIs as well as through the **nbn**[®] RSP Support Centre.

9.3.2.4 Timing of wireless performance reporting

nbn will make:

- Wireless Performance Reports available to your organisation weekly (except that **nbn** will not make a report available in the weeks during which Christmas Day, Boxing Day and New Year's Day fall); and
- each Wireless Performance Report that is made available to your organisation available 2 Business Days after the end of the week to which the Wireless Performance Report relates.

9.3.3 Line Rate and Information Rate reporting



Important: This section applies to **nbn**[®] Ethernet (FTTB), **nbn**[®] Ethernet (FTTN) and **nbn**[®] Ethernet (FTTC).

9.3.3.1 Subject of Line Rate and Information Rate reporting

nbn will prepare a daily Line Rate and Information Rate Report for all **nbn**[®] Ethernet (FTTB), **nbn**[®] Ethernet (FTTN) and **nbn**[®] Ethernet (FTTC) Ordered Products supplied to your organisation.

9.3.3.2 Content of Line Rate and Information Rate reporting

The Line Rate and Information Rate Report will include at least the following details, and such other relevant details as determined by **nbn** from time to time:

- point in time measurements of:
 - the estimated Line Rate; and
 - the estimated achievable Information Rate;
- an estimate of the rolling average of the Line Rate, calculated based on multiple point-in-time measurements;
- an estimate of the rolling average of the achievable Information Rate, calculated based on multiple point-in-time measurements; and
- an estimate of the PIR achieved over the prior period compared to the maximum PIR for the AVC TC-4 bandwidth profile of that Ordered Product, expressed as a percentage.



Important: The information contained in the Line Rate and Information Rate Report are estimates only and must be read in accordance with any disclaimers in the relevant report. Your organisation must not rely on the information contained in the Line Rate and Information Rate Report to raise a Trouble Ticket without further investigation by your organisation, including as required under section [5.2 RSP-Reported Fault Rectification](#). **nbn** may charge your organisation a No Fault Found (No Truck Roll Required) Charge or No Fault Found (Truck Roll Required) Charge (as applicable) as specified in the [nbn[®] Ethernet Price List](#) where applicable.

9.3.3.3 Delivery of Line Rate and Information Rate reporting

nbn will make the Line Rate and Information Rate Report available to your organisation via B2B Access using APIs as well as through the **nbn**[®] RSP Support Centre.

9.3.3.4 Timing of Line Rate and Information Rate reporting

The Line Rate and Information Rate Report will be made available to your organisation with regularly updated information on a daily basis.