



Assisted Drafting Tool (ADT) Guide for Designs in nbn New Developments

Customer Delivery

Document number	NBN-COO-EDS-017
Document category	Guide
Approver (owner)	Executive Manager, Customer Delivery
Status	Published
Issue date	20 MAY 24
Revision number	10.0



Disclaimer

This document is provided for information purposes only. This document is subject to the information classification set out on this page. If no information classification has been included, this document must be treated as 'nbn-Confidential: Commercial' and must not be disclosed other than with the consent of nbn co. The recipient (including third parties) must make and rely on their own inquiries as to the currency, accuracy and completeness of the information contained herein and must not use this document other than with the consent of nbn co.

Copyright © 2011 nbn co limited. All rights reserved.

Document control

Revision history

Date	Revision	Details
20 MAY 24	10.0	Refer to section 1.7 Changes in this revision, for details of changes between revision 8.0 and 9.0.
15 APR 24	9.0	Refer to section 1.7 Changes in this revision, in revision 9.0, for details of changes between revision 8.0 and 9.0.
28 FEB 23	8.0	Refer to the <i>Revision history</i> in revision 8.0, for details of changes between revision 7.0 and 8.0
04 APR 18	7.0	Refer to the <i>Revision history</i> in revision 7.0, for details of changes between revision 6.0 and 7.0
12 DEC 16	6.0	Refer to the <i>Revision history</i> in revision 6.0, for details of changes between revision 5.0 and 6.0
07 JUL 14	5.0	Refer to the <i>Revision history</i> in revision 5.0, for details of changes between revision 4.0 and 5.0
28 JAN 14	4.0	Refer to the <i>Revision history</i> in revision 4.0, for details of changes between revision 3.0 and 4.0
13 APR 12	3.0	Refer to the <i>Revision history</i> in revision 3.0, for details of changes between revision 2.0 and 3.0
09 JAN 12	2.0	Refer to the <i>Revision history</i> in revision 2.0, for details of changes between revision 1.0 and 2.0
30 JUN 11	1.0	First release.



Contents

1 About this document	7
1.1 Purpose	7
1.2 Scope	7
1.2.1 In scope	7
1.2.2 Out of scope	7
1.3 Audience	7
1.4 Referenced documents	7
1.5 Related documents	7
1.6 Additional resources available	8
1.7 Changes in this revision	8
2 Developer Agreement requirements	9
3 AutoCAD template	10
3.1 AutoCAD software requirements	10
3.2 Design settings	10
3.2.1 Layers	10
3.2.2 Drawing units	11
3.2.3 Blocks	12
3.2.4 Scaling	12
3.2.5 Base data	13
3.2.6 Title block	13
3.2.7 Projection	13
3.3 Geo-referencing	15
3.3.1 Using Google Earth and Google Maps	16
3.3.2 Using Google Earth only	21
3.4 Extended entity data (XData)	22
4 Assisted drafting tool (ADT)	23
4.1 Installation instructions	23
5 Pit and pipe drafting guidelines	24
5.1 Cadastre layer insertion	24
5.2 Standard colour format	25
5.3 Current development stage boundary	26
5.4 Development information	27



5.5	Addresses.....	28
5.5.1	Drawing requirements	28
5.5.2	ADT command (ADD)	29
5.6	Pits and manholes	31
5.6.1	Drawing requirements	31
5.6.2	ADT command (PIT)	32
5.6.3	ADT command (Manhole)	33
5.7	Conduits	34
5.7.1	Drawing requirements	34
5.7.2	ADT command (DCT)	35
5.7.2.1	Multiple conduits.....	35
5.7.2.2	Manhole and conduit configuration	36
5.7.2.3	Lead-ins	36
5.7.3	ADT command (DCTUPD)	37
5.8	Earth Potential Rise (EPR).....	39
5.8.1	ADT command (EPR)	39
5.9	Shared trenches	40
5.9.1	ADT command (STR).....	40
5.10	Telstra PIT	40
5.10.1	Drawing requirements	40
5.10.2	ADT command (TPT)	40
5.11	Smart places non-premises locations (NPL)	41
5.11.1	ADT command (PIT)	41
5.11.2	ADT command (ADD)	43
5.12	Bill of materials (BOM).....	46
5.12.1	Drawing requirements	46
5.12.2	ADT command (BOM).....	47
5.13	Quality audit for pit and pipe design	48
5.13.1	ADT command (QA).....	49
6	Pathway drafting guidelines	51
6.1	Cadastre layer	51
6.2	Current development stage boundary	52
6.3	Development information	52



6.3.1	ADT command for the Development Block.....	53
6.4	Addresses.....	54
6.4.1	ADT command (ADD)	54
6.5	MDU ADT commands	56
6.5.1	Riser (Riser).....	57
6.5.2	Access panel (AP).....	57
6.5.3	Penetration (PET)	57
6.5.4	Optional Battery Backup PSU (OBBPSU)	57
6.5.5	NTD (NTD).....	57
6.5.6	Building distribution equipment (PDH, CTL, FDT, CET)	57
6.5.7	Cable tray (CTR).....	58
6.5.8	MDU truncation of pathway conduit (MDU_DCT).....	58
6.5.9	Duct update (DCTUPD).....	58
6.5.10	Lead-in (DCT)	58
6.6	Quality audit for MDU pathway design	59
6.6.1	ADT command (MDU_QA).....	60
7	Checklists	63
7.1	Pit and pipe.....	63
7.2	Pathways	63
8	Contact us.....	64
8.1	Design submission and queries	64
8.2	Support.....	64
9	Glossary.....	65

Figures

Figure 1.	Layers from the PIT&PIPE NEWDEVELOPMENT filter group.....	10
Figure 2.	Drawing units.....	11
Figure 3.	Map grid of Australia	13
Figure 4.	Correctly placed drawing	14
Figure 5.	Corrupt image in KMZ file	14
Figure 6.	Bad cadastre layer example.....	24
Figure 7.	Good cadastre layer example	25
Figure 8.	Current development stage boundary.....	26



Figure 9. Conduit	34
Figure 10. Matching multiple conduits	35
Figure 11. Distinct multiple conduits	36
Figure 12. Distinct multiple conduits (manhole)	36
Figure 13. Example of BOM in the drawing	47
Figure 14. Good cadastre layer example	51
Figure 15. Current development stage boundary	52

Tables

Table 1. Drawing unit set-up	11
Table 2. Font style set-up	12
Table 3. Required blocks	12
Table 4. Title block and view ports	13
Table 5. Development attributes	27
Table 6. Address block attributes	29
Table 7. Pit types	31
Table 8. NBN_PIT- block attributes	32
Table 9. Parts of conduit drawing	34
Table 10. XData attributes for DUCT	34
Table 11. NBN_CAP block attributes	36
Table 12. NBN_TPT block attribute	40
Table 13. NBN_BOM block attributes	46
Table 14. QA command	48
Table 15. NBN_FIX text description	49
Table 16. Development block attributes	52
Table 17. Address block attributes	54
Table 18. MDU ADT commands	56
Table 19. NBN_CAP block attributes	59
Table 20. MDU_QA command	59
Table 21. NBN_FIX text description	60



1 About this document

1.1 Purpose

The purpose of this document is to provide Developers with information on how to use the AutoCAD template and Assisted Drafting Tool (ADT) to create New Development pit and pipe and pathway designs for review by **nbn** in accordance with their applicable Developer Agreement.

1.2 Scope

1.2.1 In scope

Pit and pipe and pathways designs for New Development Single Dwelling Units (SDUs) and Multi-Dwelling Units (MDUs).

1.2.2 Out of scope

Activity not related to producing designs for pit and pipe or pathways, using the ADT, for submission to **nbn**.

1.3 Audience

This document is intended for Developers and consultants who are engaged in the design of New Estate Developments being built with **nbn**[®] New Developments.

1.4 Referenced documents

Document	Owner
[1] NBN-TE-CTO-194 New Developments – Deployment of the nbn Pit and Conduit Network	nbn

1.5 Related documents

Document no.	Title	Link
EDS-017, Attachment 1	Pre-Construct Handover Checklist	Upload designs nbn (nbnco.com.au)
EDS-017, Attachment 2	As-Built Handover Checklist	Upload designs nbn (nbnco.com.au)



1.6 Additional resources available

There are a number of resources available on the **nbn** website: [Download the ADT tool | nbn \(nbnco.com.au\)](https://nbnco.com.au):

1. SDU ADT tool zip files containing:
 - a. **ADT.VLX** (Assisted Drafting Tool – ADT - file)
 - b. Templates
 - **New_Development_Template_2023_v2.dwt** (AutoCAD template)
 - **New Developments SDU Pit & Pipe Sample.pdf**
2. MDU ADT tool zip files containing:
 - a. **ADT_2018_v2_0_1.VLX** (Assisted Drafting Tool – ADT - file)
 - b. Templates
 - **MDU New Development Sample Design 2018.dwf** (can be viewed with ‘Autodesk Design Review’, a free download software)
 - **MDU New Development Sample Design 2018.pdf**
 - **New_Development_Template_2018_v2_0_1.dwt** (AutoCAD template)

1.7 Changes in this revision

Changes in this document revision 10.0 dated 20 MAY 24 compared to the previous revision 9.0 dated 15 APR 24 are summarised below:

Section	Details
Cover page	<ul style="list-style-type: none">• Changed title from ‘nbn New Development Pit and Pipe Design Guidelines’ to ‘Assisted Drafting Tool (ADT) Guide for Designs in nbn® New Developments’.



2 Developer Agreement requirements

Note:



- The Developer Agreement refers to the Master Developer Agreement, Online Terms and conditions and/or any other relevant agreement made with **nbn** for the purposes of engaging **nbn**® New Developments for the supply of Network infrastructure, per that agreement.
- Where the words 'you' or 'your' appear in this document, they are referring to you as the Developer.

This document does not affect Developer's obligations under their Developer Agreement or other agreement with **nbn**.

The Developer must submit the design for comment by **nbn** and the design remains the responsibility of the Developer, regardless of any review or commenting by **nbn** on the design.

As part of its agreement with **nbn**, the Developer warrants that the design for each stage will:

- a. Comply with all **nbn** specifications as required by the Developer Agreement.
- b. Be fit for the purpose of constructing the Works and installing and housing the Network Infrastructure in that stage, as reasonably ascertainable from the **nbn** specifications.

nbn may make comments on, or have additional requirements for, a design even after it has been submitted and the Developer needs to take those comments into account (whether covered in this document or otherwise) to modify the design accordingly and resubmit it to **nbn**.

The Developer must not commence building until **nbn** has confirmed it has no additional comments on the design, or **nbn** has not provided any comments on the design within 20 business days of it being submitted (or if submitted before the Developer Agreement is signed, 20 business days from the Developer Agreement being signed).



3 AutoCAD template

3.1 AutoCAD software requirements

External plant drafting must be done using industry standard AutoCAD software and the fundamental 'Model Space' and 'Paper Space' CAD drafting approach.

It is assumed that users undertaking CAD drafting for **nbn** are conversant with use of 'Model Space' and 'Paper Space' in an AutoCAD environment.

The most recent version of AutoCAD to be used is AutoCAD 2013-R18.



Note: All submissions must be in **.DWG format** and saved in **version 2013** or earlier.

3.2 Design settings

The AutoCAD template includes layers, drawing units and blocks. Each design setting is explained in detail and is intended to assist you in adhering to **nbn**'s CAD standards. The sections below outline the drawing set-up required for each design setting.

3.2.1 Layers

There are many layers included within the template.

The names are specific to **nbn** systems and are to be used, as presented, to load data into **nbn**'s database.

To assist with the design of pit and pipe, a filter group called **PIT&PIPE-NEWDEVELOPMENT** has been created and all layers required must be added to this filter group.

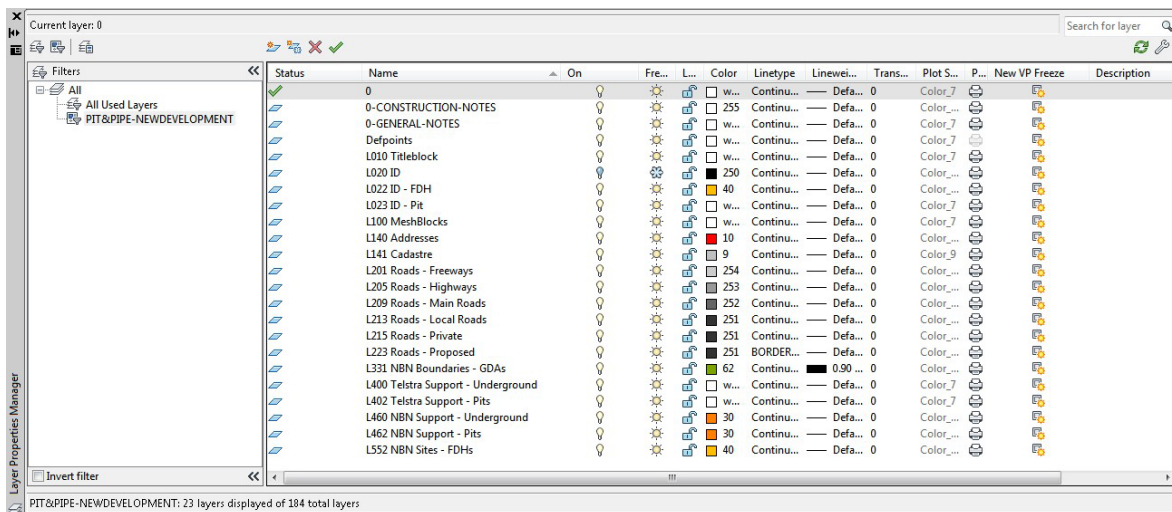

Figure 1. Layers from the PIT&PIPE NEWDEVELOPMENT filter group



Note: Developers must not add their own layers to this list, and the pit and pipe network must be captured on the specified layers.



3.2.2 Drawing units

Drawing units must be set up as per the table below:

Table 1. Drawing unit set-up

Drawing Unit	Field	Value
Length	Type	Decimal
	Precision	0.00
Angle	Type	Decimal Degrees
	Precision	0.00
	Clockwise	Unticked
Insertion scale	Units to scale inserted content	Unitless
Direction Control - Base Angle	East	0

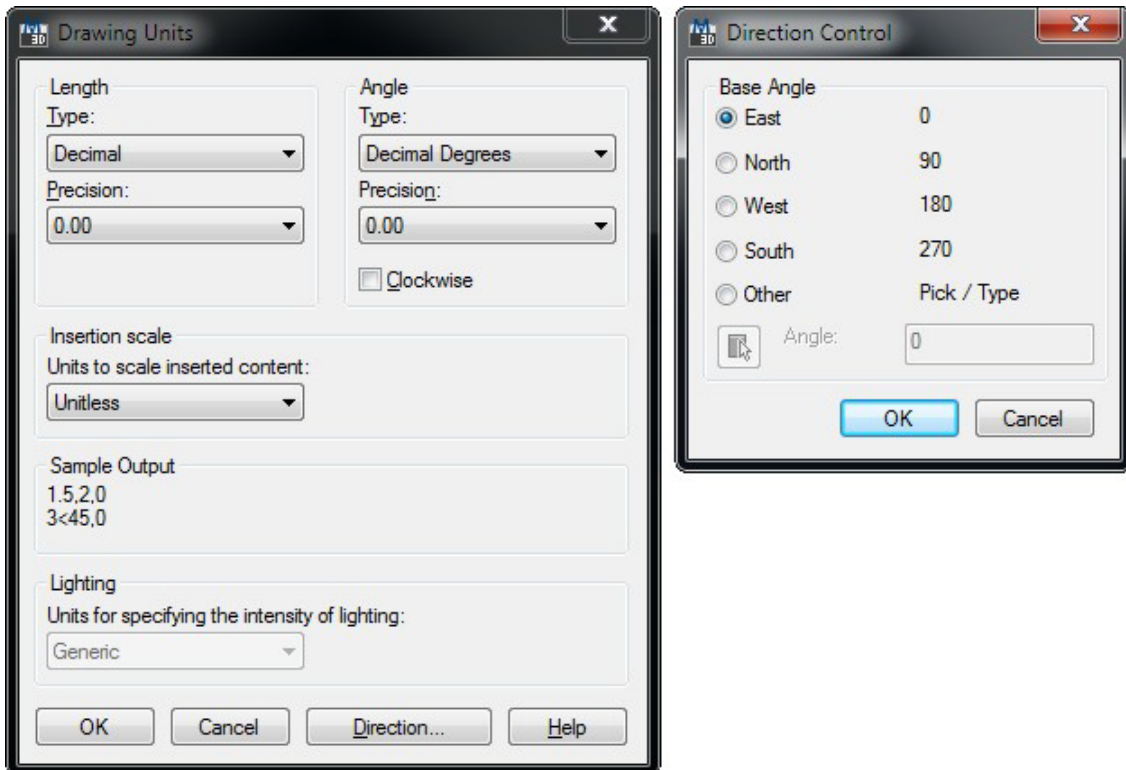

Figure 2. Drawing units



Font style must be set up as per the table below:

Table 2. Font style set-up

Unit	Value
Style in use	Standard
Font Style	Regular
Width Factor	0.8
Font name	ISOCPEUR
Height	2.0
Oblique Angle	0.0

3.2.3 Blocks

The table below shows the blocks from the template that must be present in your drawing for the ADT to function properly.

Table 3. Required blocks

Block	Description
NBN_PIT	nbn Pit
NBN_TRENCH_ANNO_TYPE	Duct Type Annotation (P100, P50, etc)
NBN_TRENCH_ANNO_LEN	Duct Length Annotation (in metres)
NBN_A1	Title Block
NBN_CAP	End Cap
NBN_TPT	Telstra Pit
NBN_FDH	FDH Cabinet
NBN_BOM_2017	Bill of Material
NBN_FIX	QA Issue Tracker (a tag which the QA command attaches to a wrongly designed Pit or Duct).
NBN_NDI	Development Information
NBN_ADDRESS_SDU	Lot Number

3.2.4 Scaling

Although the scale is set to **UNITLESS**, you must draw property boundary lines on a 1:1 scale using **METRES**. This ensures that segments of network are drawn accurately using the nominated blocks.



3.2.5 Base data

Property survey data must be placed in the **L141 Cadastre** layer of the drawing.

Street names must be placed in the **L140 Addresses** layer.

Street numbers inside the development boundary must be created with the **ADD** command and placed in the **L140 Addresses** layer.

Any other base data can be placed in the layers not designated for exclusive use by the ADT commands. The designated layers are mentioned throughout in this document.

3.2.6 Title block

When preparing a drawing, the **Title Block** and **View Ports** must be placed on the correct layer, as per the table below:

Table 4. Title block and view ports

Item	Layer
Title Block	L010 Titleblock
View Ports	DefPoints

3.2.7 Projection

All designs must be geographically oriented to the GDA 94 datum with the correct MGA projection for the area of the country you are working in. The country is divided into 8 zones for each 6 degrees of longitude.

For example, all towns East of Longitude 150 use MGA Zone 56 (GDA94).

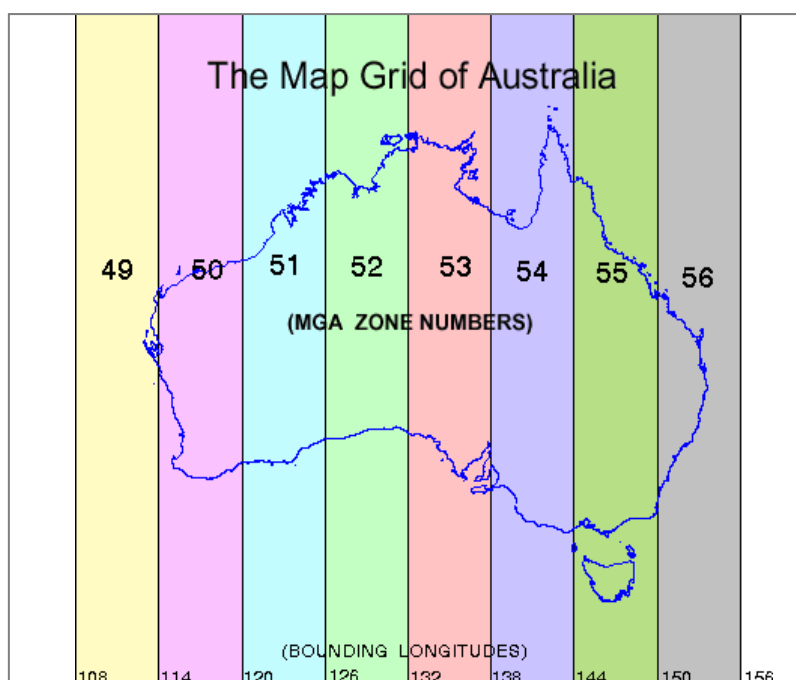

Figure 3. Map grid of Australia



Use the above map as a guide to determine the correct MGA Zone for the file you are preparing.

More information can be found at: <http://www.icsm.gov.au/datum/geocentric-datum-australia-1994-gda94>.

All surveyed data must have the correct geographical location (i.e. it must be 'geo-referenced') for your design to be commented on by **nbn**.

! **Note:** The first item checked on designs submitted to **nbn** is the MGA zone. If designs are submitted with **incorrect Projection** and/or **incorrect MGA Zone Easting's and Northings**, **nbn** will request that the design is corrected and resubmitted.

All drawings will be tested at **nbn** by producing a *Google Earth* KMZ file version of the cadastre layer. A drawing correctly referenced to its MGA zone will look correctly placed on the surface of the Globe.



Figure 4. Correctly placed drawing

A drawing which is not correctly referenced to its MGA, will look corrupt in the KMZ file:

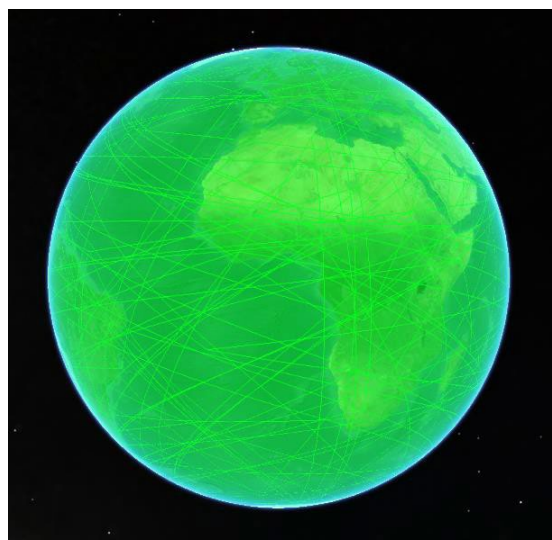

Figure 5. Corrupt image in KMZ file



Incorrectly geo-referenced drawings will be rejected, and a similar image screenshot sent back to you. In these cases you must go back to your surveyor and request them to provide you with the correct cadastre (property) layer.

If that option is not available, you can geo-reference your current design yourself in most cases. Refer to the section below for details on how to do this.

3.3 Geo-referencing

Google Earth, sometimes in combination with *Google Maps*, can be a good choice for solving geo-referencing problems with a completed, but misplaced - against Australian landmass - drawing.

Geo-referencing is about finding at least three points visible in both *Google Earth/Google Maps* and your drawing and then moving, scaling and rotating your drawing to make its three points (base points) match the points on the ground (reference points).

Rubber Sheet feature (ADERSHEET command) in AutoCAD Map 3D is very helpful with the latter. The steps below describe geo-referencing without the Rubber Sheet feature.

Just setting your drawing to the correct MGA zone number does not geo-reference the drawing automatically. The actual Eastings and Northings coordinates are important and must be correct. nbn's Internal Drawing Quality Audit/Conversion tool will apply those coordinates to the correct zone number. So this setting is for information purposes only.

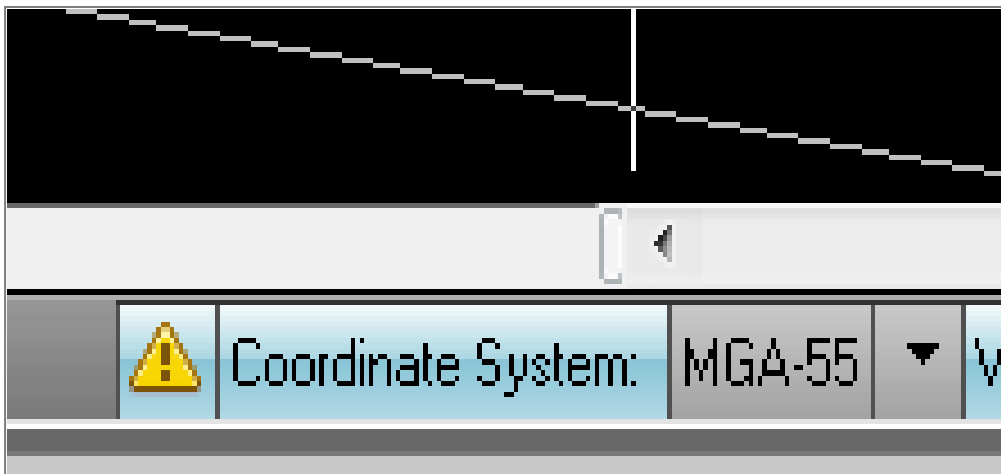

Figure 5. Coordinate system setting

3.3.1 Using Google Earth and Google Maps

The steps below describe how to use *Google Earth* in combination with *Google Maps*.

Note: Sometimes lot boundaries only can serve as a visual reference. You will need to pick the true coordinates from the lot boundaries visible in *Google Maps*.

1. From the **3D View** tab in *Google Earth Options*, select **Decimal Degrees**.

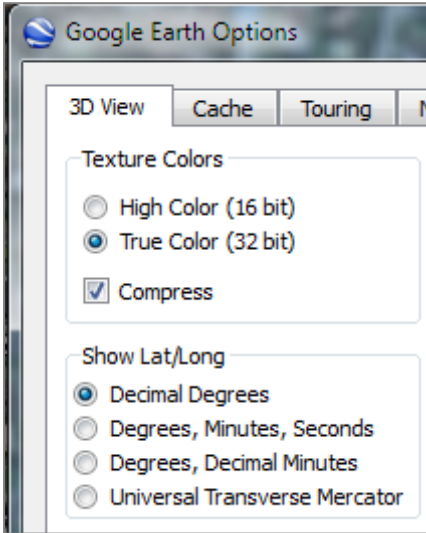

2. Create three place marks in *Google Earth*, approximately in the corners of the block.
3. Open *Google Maps* and move to the same location.

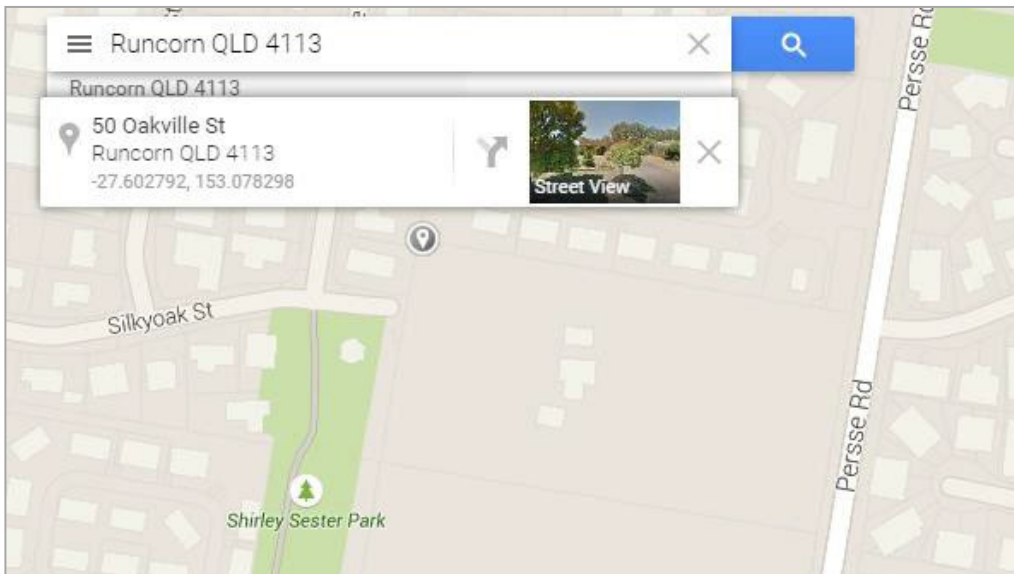



- Rectify each placemark's coordinates by clicking on exactly the block corners you can see in *Google Maps* and entering the displayed coordinate values into the relevant *Google Earth - Edit placemark* dialog box.

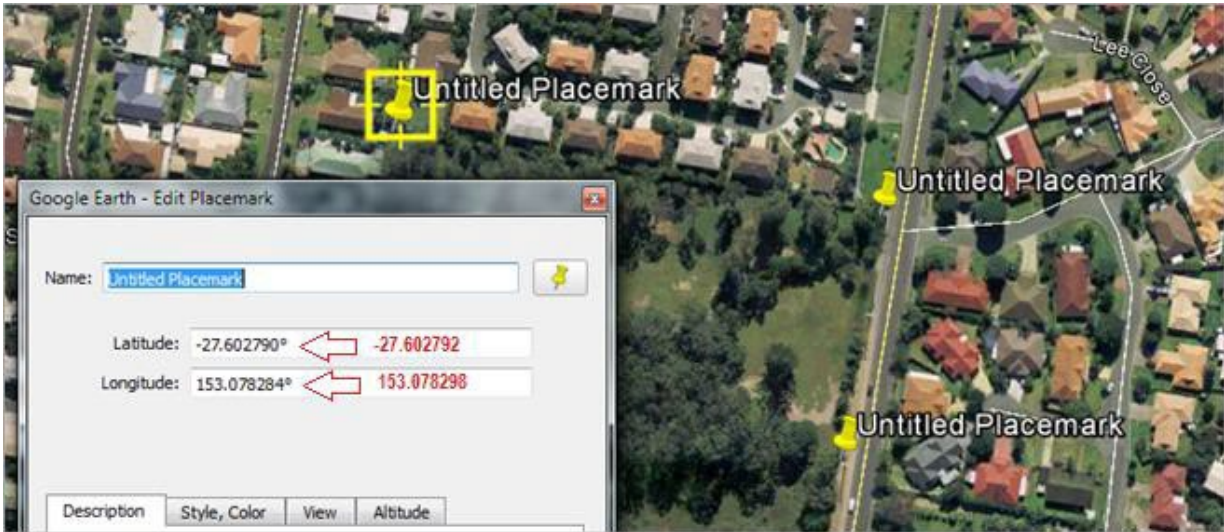

- From the **3D View** tab in the *Google Earth Options*, select **Universal Transverse Mercator (UTM)**.

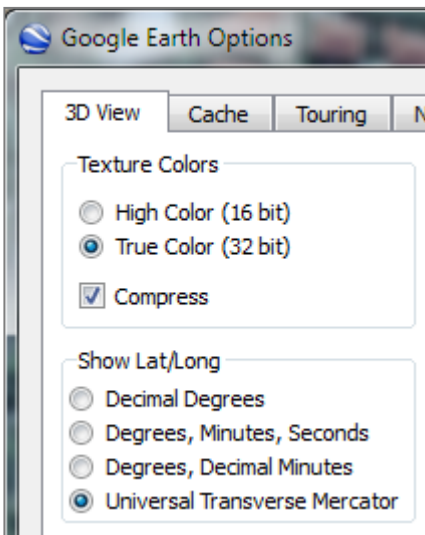

This gives you the zone and zone coordinates for each placemark.

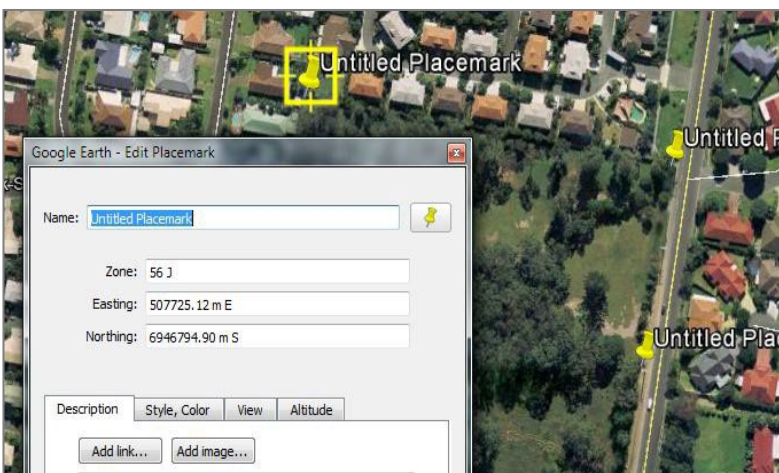



- 6. Draw lines connecting those UTM point coordinates in your design.
- 7. Copy the line angle from the properties window.

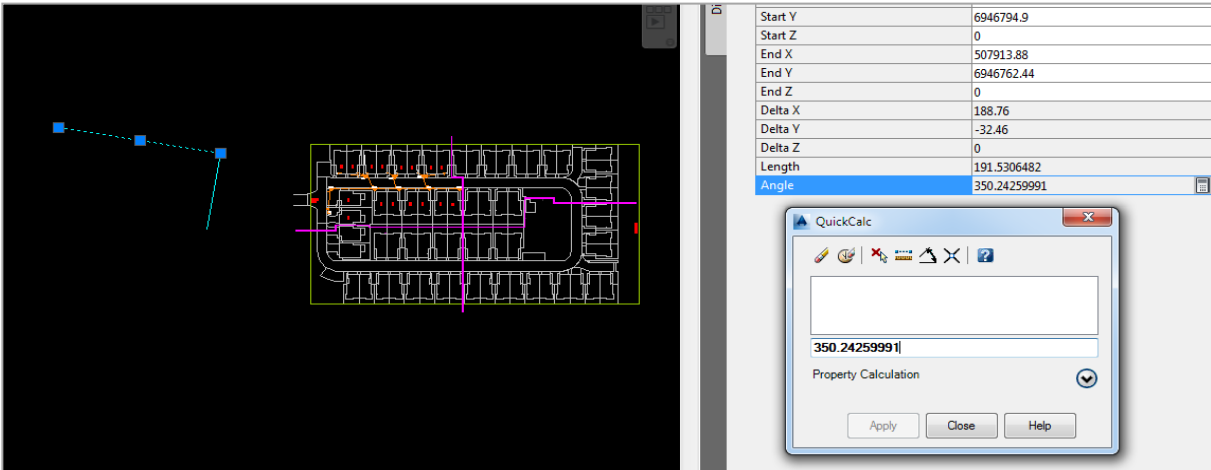

- 8. Rotate the drawing to match the angle.

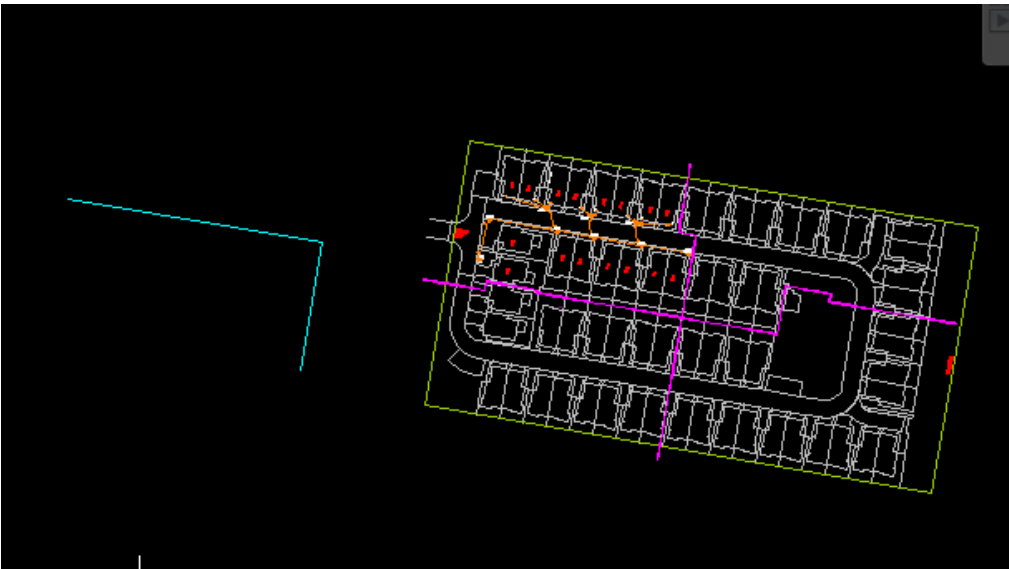

- 9. Scale the drawing up or down to make it occupy the expected footprint.

Note: The scale factor is roughly 0.5 in the example below.

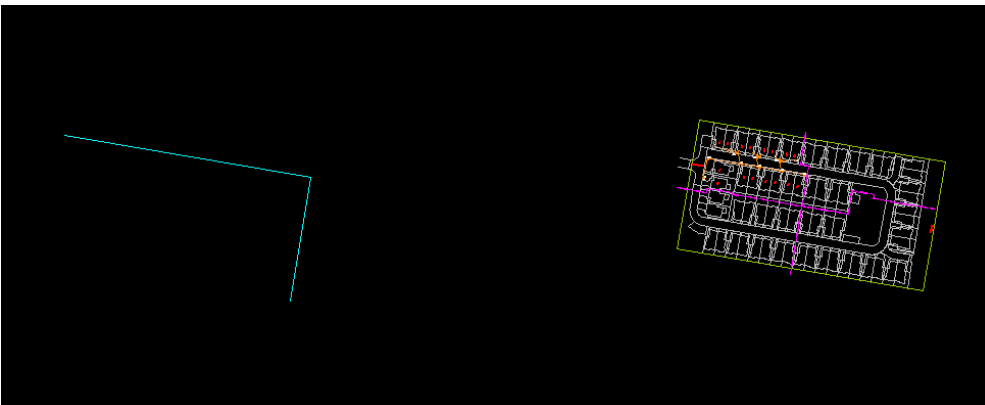



10. Move the drawing into place.

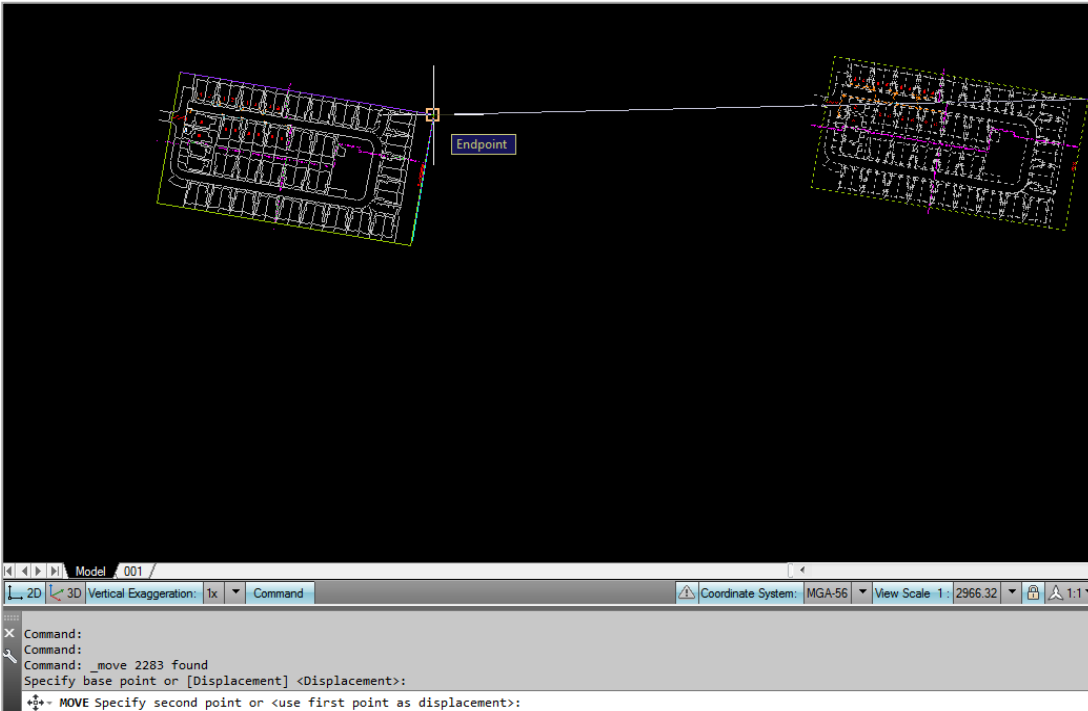

It should now be in the right location.





11. The **nbn** Internal Drawing Quality Audit/Conversion tool will produce a KMZ file image located correctly when opened in *Google Earth*.

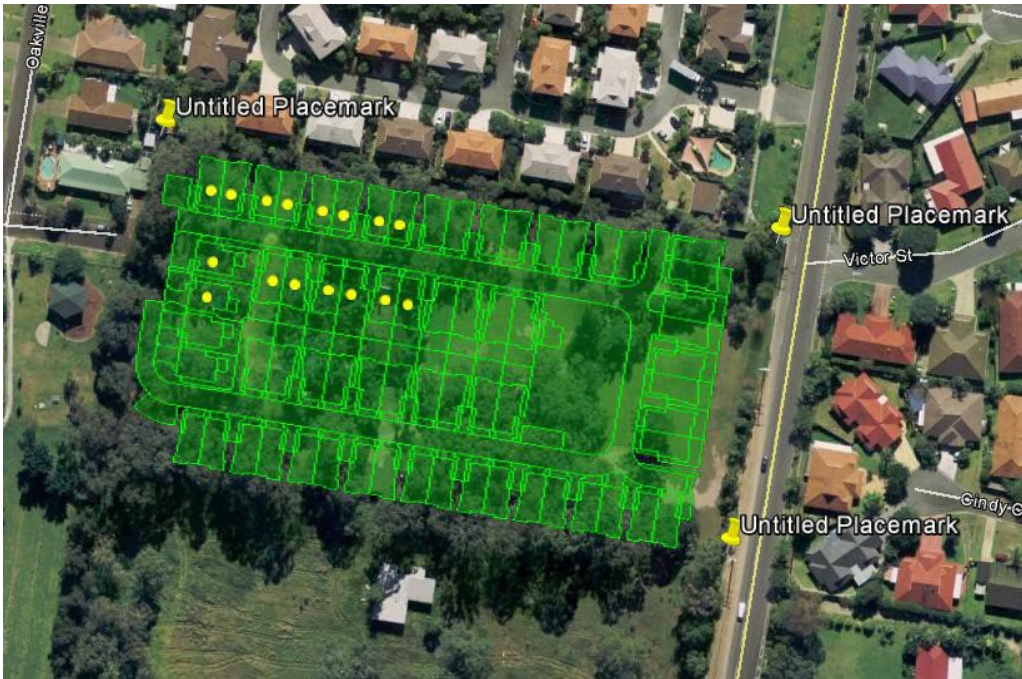

Note: Sometimes you have to zoom to 'Extents' to be able to see both your drawing and the reference points. Use the Clipboard to cut and paste the drawing closer to its reference points. Rotation, scaling and final moving to the position will be easier once this is done.

In the example below, the drawing is too far away from the correct location:





3.3.2 Using Google Earth only

In most cases it is easy to identify reference points in *Google Earth* directly. This process involves fewer steps as per the example below:

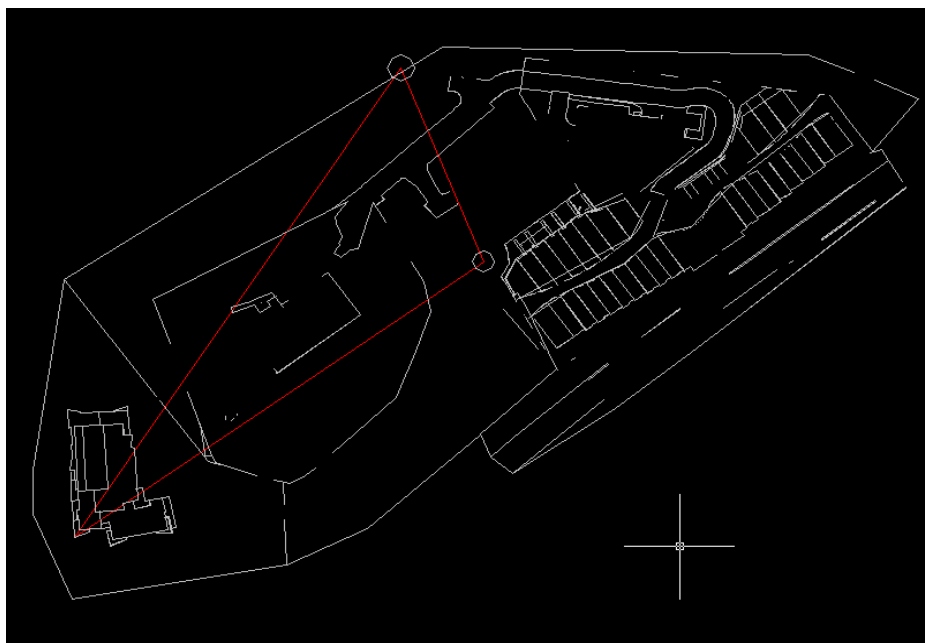

1. From the **3D View** tab in the *Google Earth Options*, select **Universal Transverse Mercator (UTM)**.

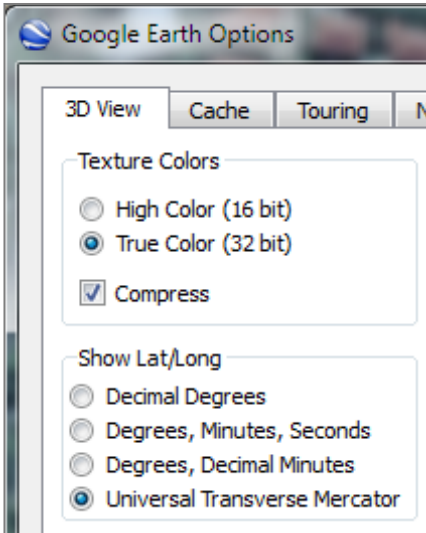

2. Create *Google Earth* placemarks at the reference points and use these coordinates in your drawing to create reference points.

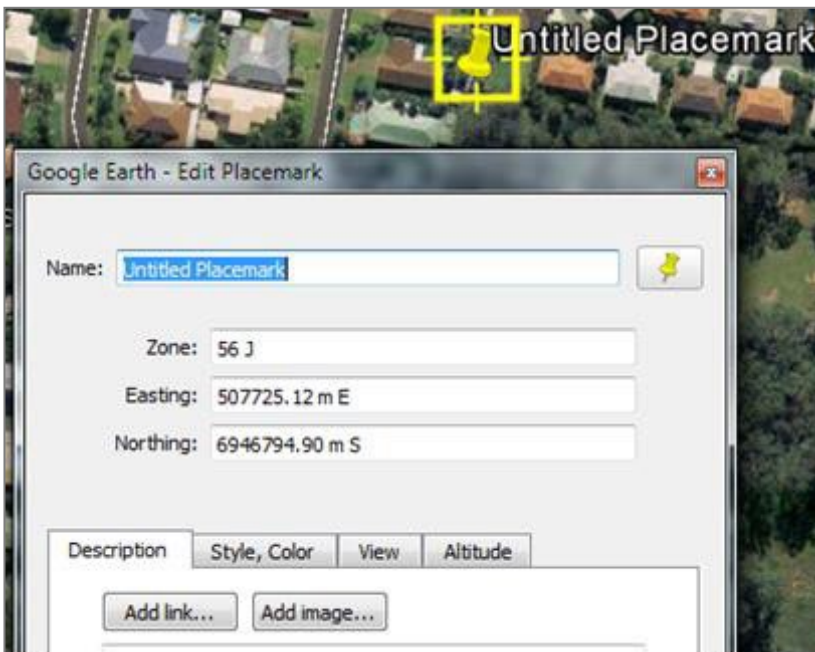

3. Move/scale/rotate the drawing to match the drawing's base points to reference points as already described.

3.4 Extended entity data (XData)

XData is attached to CAD entities as a necessary requirement for the translation of attribute data between the AutoCAD .dwg file and the **nbn** Physical Network Inventory (PNI) database.

This is in addition to the standard object data attributes that are used purely for visual representation.

The ADT creates XData where necessary during its use. XData should not be edited directly. Objects containing XData should not be copied or moved around, as XData reflects the topology of the network.



4 Assisted drafting tool (ADT)

The ADT is provided on the **nbn** website to assist in capturing the **nbn**[®] pit and pipe and pathway network and in auditing the design for compatibility with the **nbn** CAD requirements and database compatibility before submission.

Please note the following when using the ADT:

1. The tool is designed to automate the process of pit and pipe drafting and its use is **mandatory**.
2. To exit any command you **MUST** press **<Enter>**, NOT **<Esc>** (pressing **<Esc>** breaks the loop and breaks the program).

The **nbn** approved template has been provided to you to complete with the details of your design and to assist you in providing a design that is consistent with **nbn** CAD standards for pit and pipe network elements. The template includes all required Blocks, Layers and settings.

4.1 Installation instructions

Download the zip file containing the tool from the **nbn** website (refer to section 1.6 for details) and save all files to your computer.

Load the tool into the drawing as follows:

1. Open the **nbn** AutoCAD Template.
Note: The ADT does not work with other templates.
2. Type **APPLOAD** in the command line.

The *Load/Unload Applications* screen will display prompting you to browse for the file you want to load:

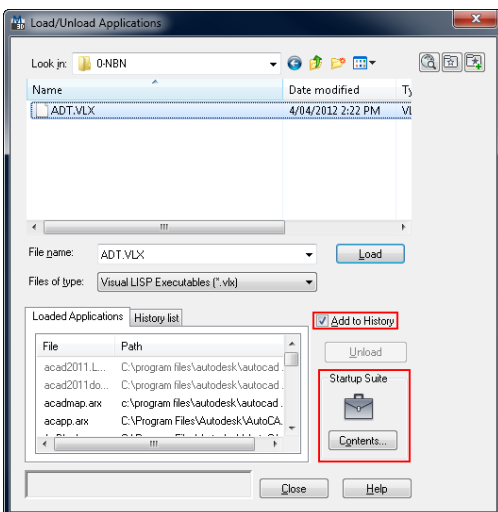

3. Select the **ADT.VLX** file (or its updated version) and click **Load**.



Note: If the file is not added to history and start-up suite, it will need to be loaded every time you open a drawing.



5 Pit and pipe drafting guidelines

This section describes the methods of data capture to assist you in complying with **nbn** CAD and database compatibility standards.

5.1 Cadastre layer insertion

Before you begin, ensure the cadastre (or property survey data) has been copied into the **L141 Cadastre** layer.



Note: The **PIT** command will not work if the cadastre layer is not set to **L141 Cadastre**.

Keep the cadastre layer as simple as possible.

The **nbn** Internal Drawing Quality Audit/Conversion tool creates a polygon out of any line work that looks like a polygon visually, because polygons are expected to be lot boundaries primarily.

Unnecessary cadastre layer imagery will slow the processing of your drawing considerably, causing a queue to form. This will result in a delay in the review of your and other people's drawings.

The Cadastre layer must contain only the line work helpful with pit placement when using the ADT PIT command and must also provide sufficient visual reference for easy drawing review by **nbn** (i.e. lot boundaries, roads, roundabouts, footpaths, driveways, road reserves and parking bays).



Figure 6. Bad cadastre layer example

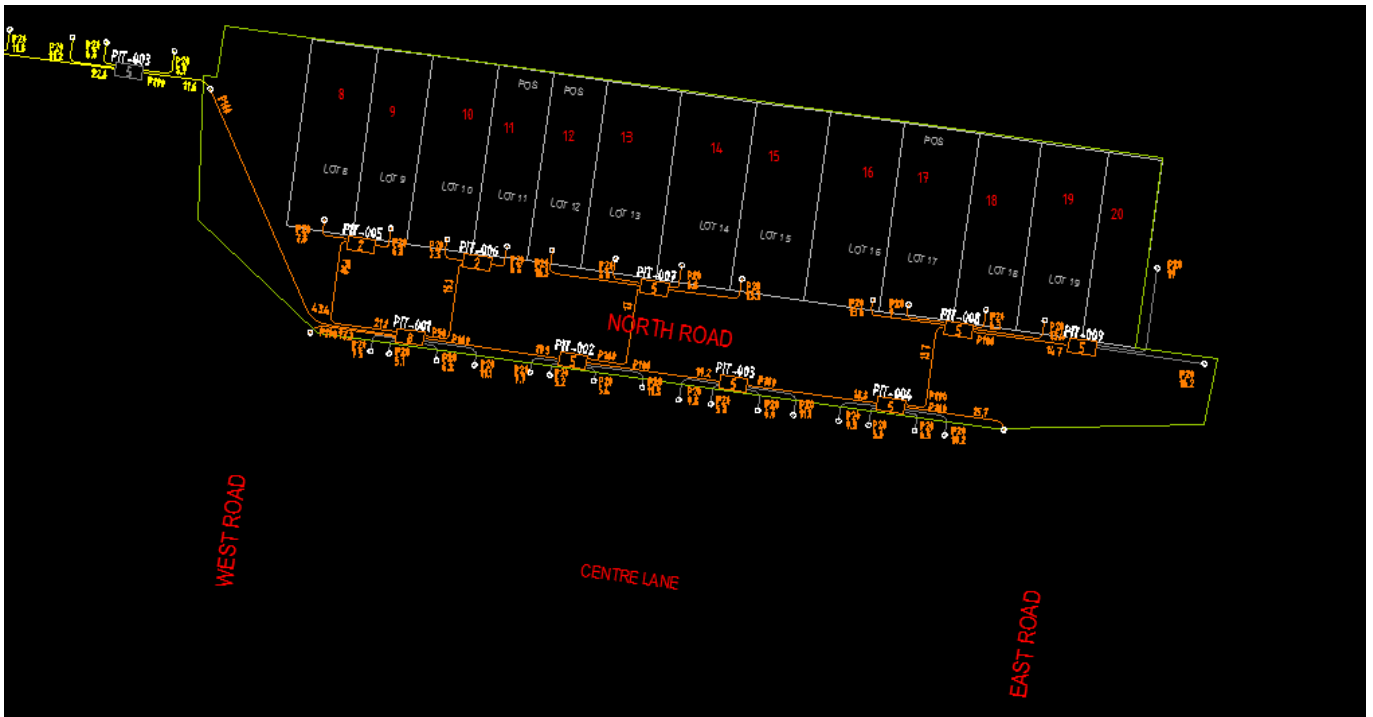

Figure 7. Good cadastre layer example

5.2 Standard colour format

To show previous stages, future submissions, other carrier networks etc. it is important to follow a standard colour format.

The use of a standard colour format enables **nbn** to review submissions quicker and with greater accuracy.

The table below details the standard colour format:

Colour	Description
Grey (8)	Future stages / Future submissions / Separate layer
Orange (30)	Current Development stage / Current development submission
Blue (5)	Other Carrier's networks (e.g. Telstra, Optus)
Red (1)	Current stage As-Built
Yellow (2)	Existing nbn [®] pit and pipe network. Note: Existing pits connected to the current stage must stay in the L462 NBN Support – Pits layer. All other existing network should be moved to a non-nbn layer.

5.3 Current development stage boundary

The Current Development Stage Boundary must go around the pit and pipe drafting area. For Horizontal Multi-Dwelling Units (HMDUs) the pit and pipe drafting area is inclusive of all street facing premises and pit and pipe connectivity of these premises must link to the internal pit and pipe of the development.

The ADT tool works inside the boundary. The boundary must consist of one closed polyline. It must be in the **L331 NBN Boundaries - GDAs** layer and the boundary colour must be **ByLayer**.

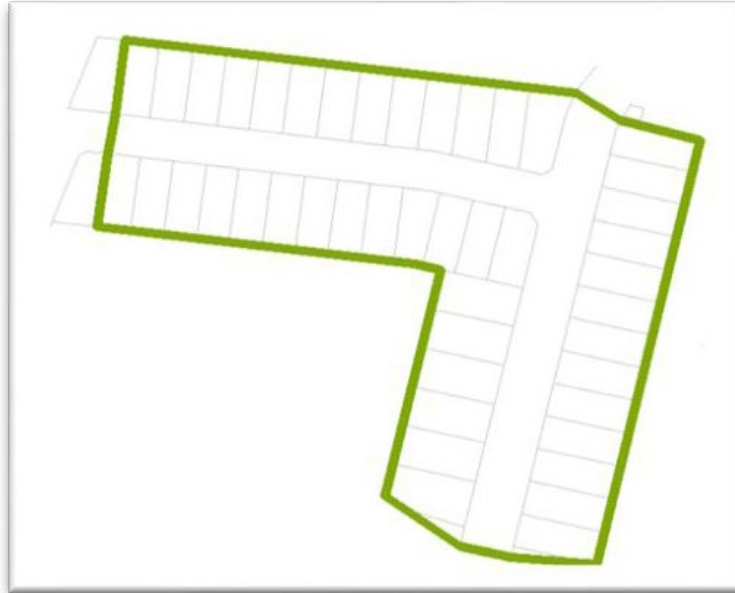

Figure 8. Current development stage boundary



5.4 Development information

Development information must be present in the drawing.

! **Note:** All fields in the development information block **NBN_NDI** should be populated. The **NBN_NDI** block should be in the **0-GENERAL-NOTES** layer.

Table 5. Development attributes

Attribute	Description
DEV_NAME	Development name
DEV_COMP	Development company
DEV_ADD	Development address
DEV_NBNREF	NBN Reference number for Development
DEV_STG	Development stage
DEV_REP	Development authorized representative
DEV_MOB	Authorized representative's phone number
DEV_EML	Authorized representative's email



Figure 9. Example of development information in the drawing



5.5 Addresses

5.5.1 Drawing requirements

Address/lot information must be captured in the drawing.

The BOM command (refer to section 5.12 Bill of materials) counts the total number of address blocks in the drawing, and must be in the **NO OF LOTS** section.

The ADT uses the **NBN_ADDRESS_SDU** block to present lot numbers in the drawing. Line type and line weight must be set to **ByLayer**.

Note: To display the street name and assist in automating the addressing process, address texts (either Text or MText) must be in the **L140 Addresses** layer. Street name and street type should be one Text/MText object. For example, creating **MARBLE** as one text object and **LANE** as another text object, in the case of **MARBLE LANE**, is incorrect.



Figure 10. Example of street name as one MText object



The ADT places the **NBN_ADDRESS_SDU** block in the **L140 Addresses** layer.

Refer to the table below for **NBN_ADDRESS_SDU** block attributes.

Table 6. Address block attributes

Attribute	Prompt	Explanation
STREET_NUMBER	Enter the street number for this building.	This is the lot number of the current stage.
ID	Enter the GNAF ID of this address.	This attribute is used for data translations and should be left empty.
STREET_NAME	Enter the street name.	This is the street name for the current stage. It contains both the street name and street type e.g. MARBLE LANE.

Important: The combination of the **STREET_NUMBER** and **STREET_NAME** attribute values must be unique i.e. each street address text has to be unique. You may use the street number prefix or suffix, such as 1A, if necessary.



The **nbn** Internal Drawing Quality Audit/Conversion tool counts multiple **NBN_ADDRESS_SDU** blocks with the same street address as just one lot, while the BOM command counts all instances of **NBN_ADDRESS_SDU** block within the current stage boundary.

Any discrepancy between the total count of blocks in the BOM and the Internal Tool's count of blocks, duplicated by street address, will be reported as an error.

5.5.2 ADT command (ADD)

After loading the ADT.VLX file into the drawing, complete the following steps to insert an address:

1. Enter **ADD** in the command line then follow the prompts.

The address command counts the existing addresses inside the development stage boundary and displays as the number of 'lots'.

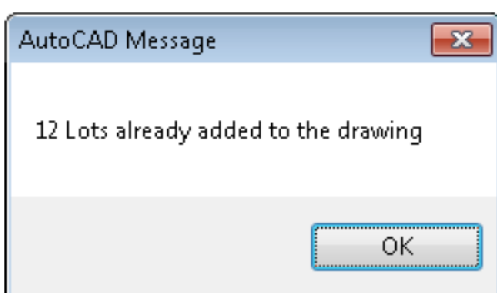



2. Click **OK** and follow the prompts below:

Prompt	Action/explanation
<p>Please pick an insertion point</p>	<p>Select the text representing the street name.</p> <p>Note: This prompt is asking you to pick an insertion point for the address block. However, your very first insertion point should always be the street name along which you are going to create addresses. You must select a street name from the L140 Addresses layer. The ADD command does not work with other layers' street name texts.</p> <div data-bbox="676 680 1098 1039" data-label="Image"> </div> <p>Above is an example of the message displayed when the street name is first selected or changed.</p>
<p>Please enter Premises</p>	<p>Enter Yes for standard premises.</p> <p>Note: for NPL premises, enter SPECIAL.</p>
<p>Please pick an insertion point</p> <p>Please enter lot number or press Enter for (x)</p>	<p>Pick the lot number location.</p> <p>Enter the lot number with the desired prefix or suffix.</p> <p>Note: You can enter the lot number or press <Enter> or <Space> to accept the default value (x) offered.</p> <p>If you choose to prefix or suffix lot numbers with letters (i.e. 1A, A1) the tool is capable of automatically assigning prefix and suffix letters for you.</p> <p>Neither suffix nor prefix get incremented automatically in alphabetic order when you click next insertion point. For example, instead of the 101A, 101B, 101C you might be expecting, the generated sequence will be 101A, 102A, 103A.</p>
<p>Please pick an insertion point</p>	<p>You are now in the loop of creating new addresses. From here on you can left-click at a new insertion point, then press <Enter> or <Space> to keep creating as many addresses as you need – if you are happy with the automatically generated lot number value.</p> <p>Other actions at this prompt:</p>



Prompt	Action/explanation
	<ul style="list-style-type: none"> Pick a different street name to start creating addresses along that street. Press <Enter> or <Space> to finish the ADD command.
Please enter lot number or press Enter for (xx):	Lot number (xx) offered as a default will be the previous value incremented by one. Accept by pressing <Enter> or <Space>. Alternatively, edit the lot number as described above.







5.6 Pits and manholes

5.6.1 Drawing requirements

The ADT uses the **NBN_PIT** block to present pits in your drawing. Line type and line weight must be set to **ByLayer**. The ADT puts **NBN_PIT** block in the **L462 NBN Support – Pits** layer.

Refer to the table below for allowed pit types.

Table 7. Pit types

Type	Symbol	Description
P2		Service Drop Access/Demarcation Pit (650mmX280mmX565mm)
P5		Network Boundary/Local Network Pit (Single Lid) (700mmX450mmX650mm)
P6		Distribution/Local Network Connection Pit (Dual Lid) (1360mmX555mmX650mm)
P8		Distribution/Local Network Connection Pit (Dual Lid) (1360mmX555mmX860mm)
P9		Fibre Distribution Hub (FDH) Pit (2000mmX555mmX900mm)
Manhole		Distribution Network manhole (2600mmX1240mmX1490mm)



Refer to the table below for **NBN_PIT** block attributes.

Table 8. NBN_PIT- block attributes

Attribute	Prompt	Explanation
NAME	Enter the nbn (or 3rd Party) Pit Name	This is nbn 's identifier for the PIT.
TYPE	Enter the Pit Size	This attribute shows the pit type or size. Note: Pit sizes allowed are 2, 5, 6, 8 or 9.

Note:

- The **PIT** command will automatically align the pit to the nearest cadastre layer polyline (e.g. property border). For example, if the line is vertical, the pit will be aligned vertically. It will also optimise the distance to the line. It will not allow you to create an active pit outside the current development stage boundary.
- There is no XData attached to the pit. Pit size can be updated by updating the **Pit Type** attribute.
- Design pits are to be offset from the boundary, so they don't interfere with any driveways or proposed driveways.
- Document NBN-TE-CTO-194 New Developments – Deployment of the **nbn** Pit and Conduit Network, section 5.2.2, describes a laneway rear load deployment solution where pits do cross the property boundary.

5.6.2 ADT command (PIT)

After loading the ADT.VLX file into the drawing, complete the following steps to insert a pit:

1. Enter **PIT** at the command line then follow the prompts below:

Prompt	Action/explanation
Please Pick an Insertion point or press enter to finish.	Left click where you want the pit to be placed. Note: Your choice of insertion point will be adjusted by the ADT to ensure the pit is parallel to the nearest cadastre layer line and is at an optimal distance from that line.
PLEASE SPECIFY WHETHER THE PIT IS A DEMARCATION PIT OR NOT.	Enter No for a standard pit or YES for an NPL pit.
Please enter the pit size or press Enter for (5):	Enter pit size. Note: Pit sizes allowed are 2, 5, 6, 8 or 9.



Note:



- The ADT automatically assigns the next sequential pit number to each new pit placed in the **L462 NBN Support – Pits** layer.
- The **PIT** command creates a pit insertion loop. To exit the loop press **<Enter>**. Do not press **<Esc>**.

5.6.3 ADT command (Manhole)

After loading the ADT.VLX file into the drawing, complete the following steps to insert a manhole:

1. Enter **MHL** at command line, then follow the prompts below:

Prompt	Action/explanation
PLEASE PICK AN INSERTION POINT OR PRESS ENTER TO FINISH	Left click where you want the manhole to be placed. Note: Your choice of insertion point will be adjusted by the ADT to ensure the manhole is parallel to the nearest cadastre layer line and is at an optimal distance from that line.

Notes:



- The ACT automatically assigns the next sequential manhole number to each new manhole in the **L462 NBN Support – Pits** layer.
- The manhole command creates a manhole insertion loop. To exist the loop press **<Enter>**. Do not press **<Esc>**.



5.7 Conduits

5.7.1 Drawing requirements

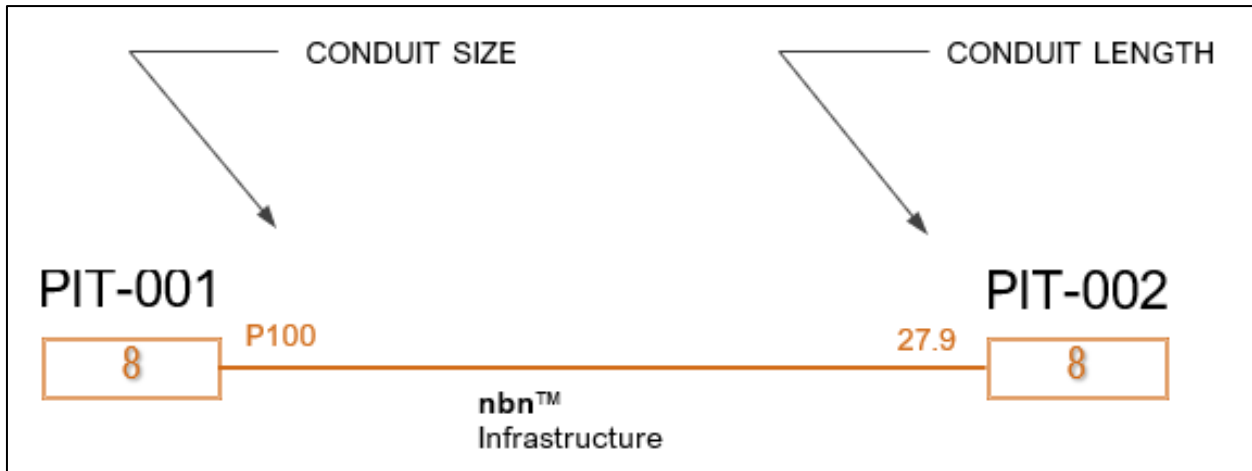

Figure 9. Conduit

Conduit is captured in the **L460 NBN Support – Underground** layer with both line type and line weight properties set to **ByLayer**.

Conduits in the drawing consist of the following:

Table 9. Parts of conduit drawing

Part	Definition
Duct Polyline	A Polyline representing a Duct
NBN_TRENCH_ANNO_TYPE	Block representing Duct Type annotation
NBN_TRENCH_ANNO_LEN	Block representing Duct Length annotation

XData attributes for DUCT – for data attribute translation:

Table 10. XData attributes for DUCT

Attribute	Definition
TYPE	DUCT (denotes the Polyline type)
ID	Duct ID (i.e. DCT-001, DCT-002)
SIZE	Duct size (P100, P50, P20)
LENGTH	Calculated length



Note: XData reflects the actual topology of the network and is populated by the **DCT** command. Ducts should not be moved or copied after being created with the **DCT** command. XData must not be changed directly either.



5.7.2 ADT command (DCT)

After loading the ADT.VLX file into the drawing, complete the following steps to insert the conduit:

1. Enter **DCT** at the command line.

The program will ask you to pick a start point of conduit and continue your conduit line to the next pit.

Note: Do not press <Esc> as this will cancel the command.

2. Press <Enter> when you finish drawing the conduit. The program draws a Polyline representing a duct.
3. **PLEASE ENTER THE CONDUIT TYPE OR PRESS Enter FOR (P100).**
4. **PLEASE ENTER CONDUIT LENGTH OR PRESS ENTER FOR (x).**

Notes:



- You have the option of entering conduit length or using the calculated length.
- The **DCT** command can capture road crossings, multiple ducts and lead-in conduits.

5.7.2.1 Multiple conduits



Note: Use the **DCT** command for multiple conduits irrespective of their type.

There are two types of multiple conduits:

- matching multiple conduits
- distinct multiple conduits

Matching multiple conduits

Conduit start and end pits are the same and the lengths of the conduits are the same. In this case two lines representing the conduits are stacked on top of each other (refer to Figure 10 below).

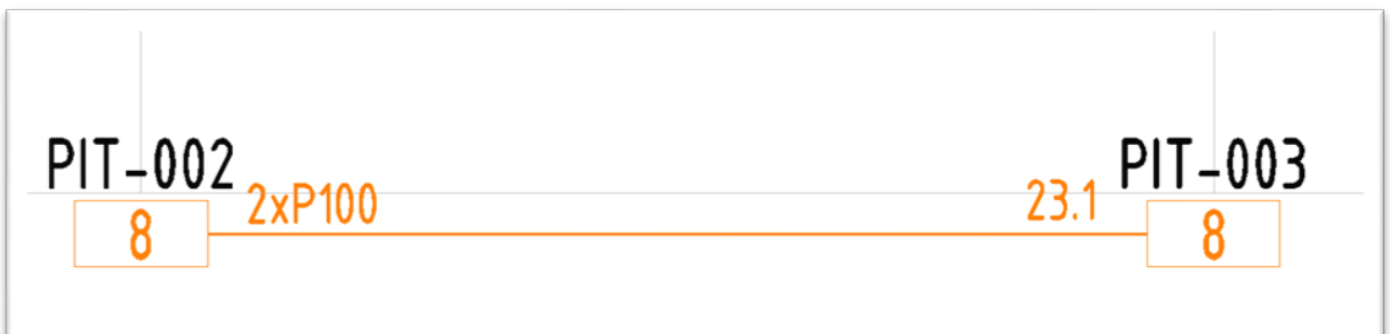

Figure 10. Matching multiple conduits



Distinct multiple conduits

Conduits are going in the same direction, but their start or end pits are not the same (refer to Figure 11 below). Separate lines must be drawn. Express conduits are an example of this type of installation. nbn may advise if express conduits are required within a Developments stage(s).

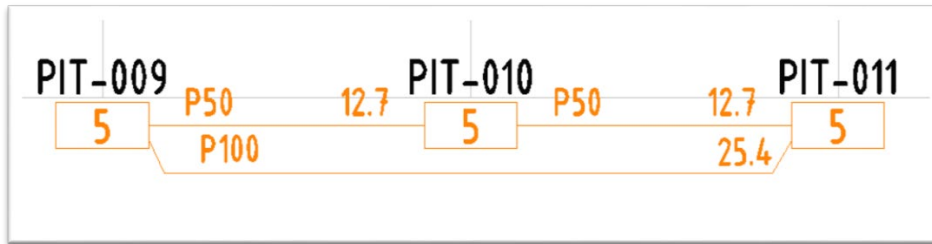

Figure 11. Distinct multiple conduits

5.7.2.2 Manhole and conduit configuration

Conduits linking between manholes from any one end can be either 6 x P100 or 4 x P100 and 2 x P50.

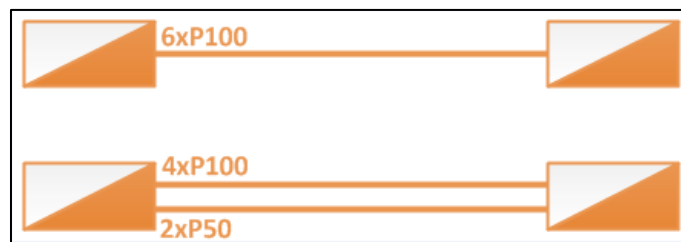

Figure 12. Distinct multiple conduits (manhole)

5.7.2.3 Lead-ins

When no **NBN_PIT** is chosen as the duct end, the **DCT** command will create a lead-in with **NBN_CAP** block as its endpoint. The **NBN_CAP** will be placed in the duct layer **L460 NBN Support – Underground**.

Refer to the table below for **NBN_CAP** attributes.

Table 11. **NBN_CAP** block attributes

Attribute	M/O	Prompt	Action/explanation
ID	M	Enter a Unique ID within this drawing for this null node.	This is the nbn identifier for the end cap and has the format NEC-XXX where XXX is a 3 digit number starting from 001 and incrementing sequentially.
TYPE	M	Enter the type for this null node.	Enter ENDCAP .



Note: The **DCT** command will place **NBN_CAP** at an end of a conduit (road crossing, or a conduit going beyond the current development stage boundary).



5.7.3 ADT command (DCTUPD)

After loading the ADT.VLX file into the drawing, complete the following steps to edit a conduit (duct update) without rebuilding it completely:

1. Enter **DCTUPD** at the command line.

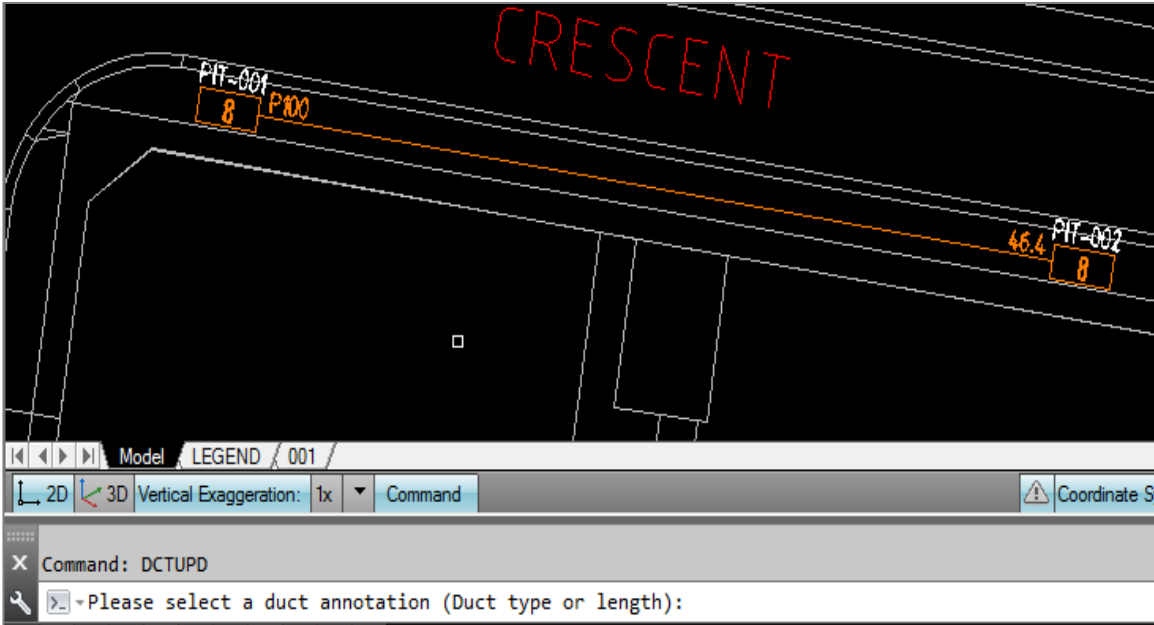

2. Select duct type annotation to edit duct type.

The program will ask you to select the line the annotation is related to.

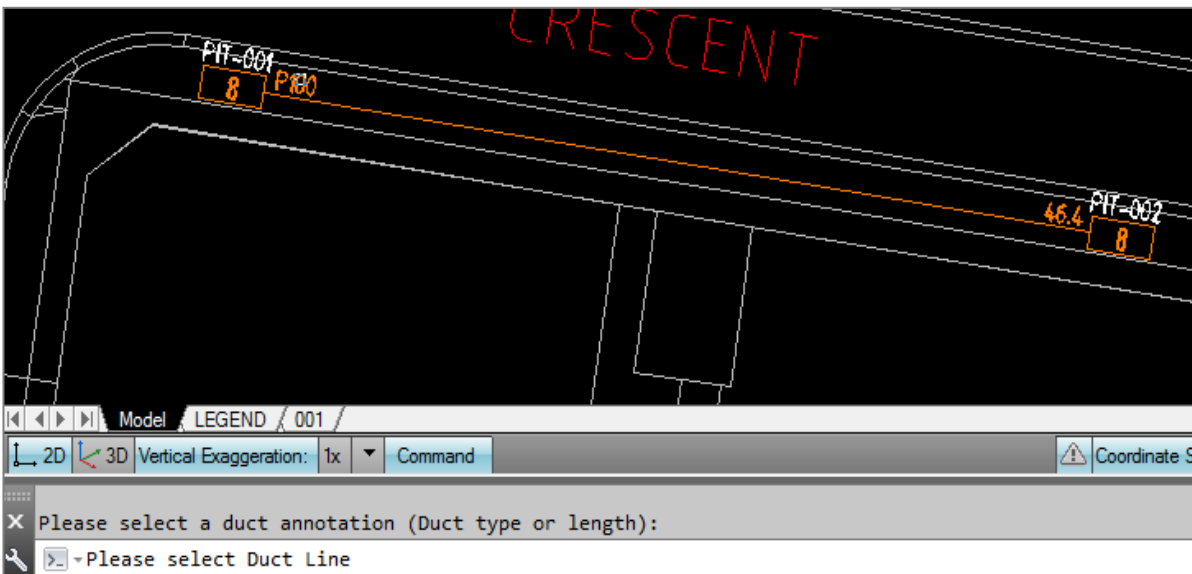



The program will ask you to enter the desired type.

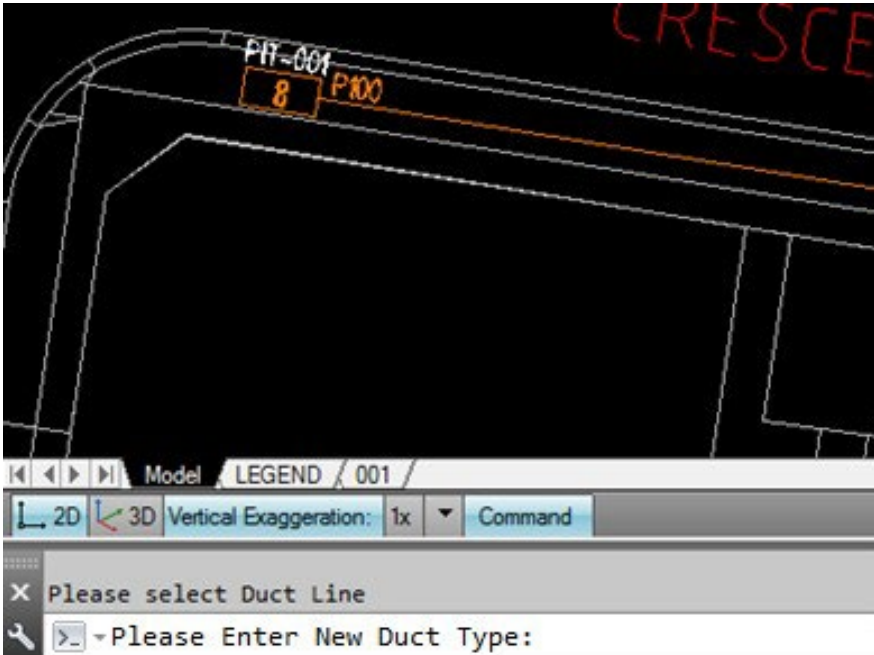

3. Enter the duct type (P50 in this example).

Note: The conduit type will be updated in both the annotation and the line XData.

Similar steps are applicable if you choose to update duct length.

In the example below, the duct length was updated to 47m and the BOM automatically reflects the changes. It would not have happened if the annotations were edited manually. **DCTUPD** changes the line's XData (BOM uses XData for its summaries).

BILL OF MATERIAL				
NO OF LOTS: 21				
PITS		DUCTS		
SIZE	QTY	SIZE	QTY	MTRS
2	0	P100	0	0
5	0	P50	1	47
6	0	P20	0	0
8	2			
9	0			
TOTAL NUMBER OF PITS:			2	
TOTAL NUMBER OF MANHOLES:			0	
TOTAL NUMBER OF CONDUITS:			1	
TOTAL LENGTH OF CONDUITS:			47	



5.8 Earth Potential Rise (EPR)

EPR Zones must be reflected in the design(s). Refer to [1] NBN-TE-CTO-194 New Developments – Deployment of the **nbn** Pit and Conduit Network, for **nbn**'s requirements in relation to pit location in respect of an EPR zone.

5.8.1 ADT command (EPR)

After loading the ADT.VLX file into the drawing, complete the following steps to insert an EPR Zone:

1. Enter **EPR** in the command line then follow the prompt below:

Prompt	Action/Explanation
PLEASE PICK AN INSERTION POINT OR PRESS ENTER TO FINISH	Left click where you want the EPR Zone to be placed.

Note:

- The EPR zone is placed in the **EPR** layer.
- The **EPR** command creates an EPR insertion loop. To exit the loop press **<Enter>**. Do not press **<Esc>**.

2. Insert EPR symbol.

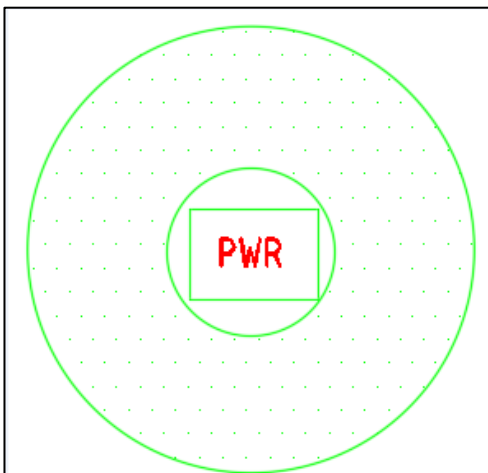



5.9 Shared trenches

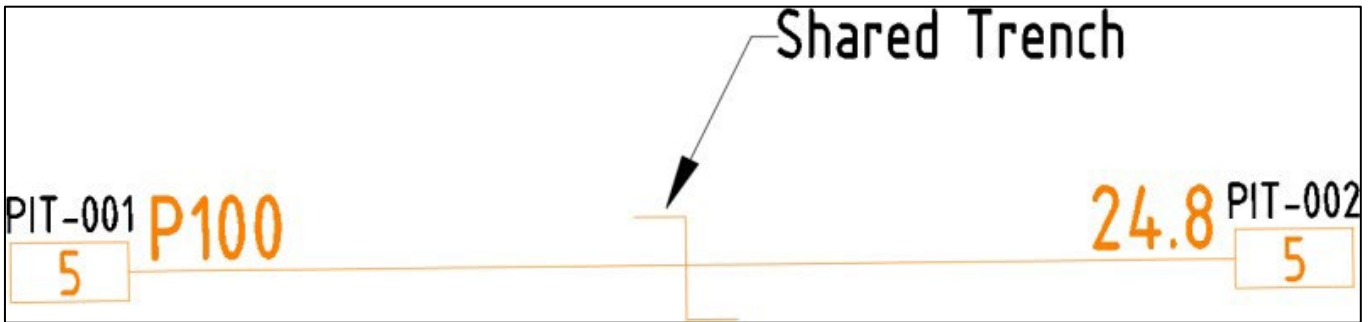

5.9.1 ADT command (STR)

After loading the ADT.VLX file into the drawing, complete the following steps to insert a Shared Trench Symbol:

1. Enter **STR** at the command line then follow the prompt below:

Prompt	Action/explanation
PLEASE PICK AN INSERTION POINT OR PRESS ENTER TO FINISH	Left click where you want the Shared Trench to be placed.

Note:

- The **Shared Trench** symbol is placed in the **Shared Trench** layer.
- The **Shared Trench** command creates a Shared Trench insertion loop. to exit the loop press **<Enter>**. Do not press **<Esc>**.

5.10 Telstra PIT

5.10.1 Drawing requirements

To capture Telstra pits, use the **TPT** command. This will place an **NBN_TPT** block in the **L402 Telstra Support – Pits** layer. Line type and Line weight properties are set to **ByLayer**. Refer to Table 12 below for **NBN_TPT** block attribute description:

Table 12. **NBN_TPT** block attribute

Attribute	M/O	Prompt	Explanation
SIZE	M	Size	The size of the Telstra Pit

5.10.2 ADT command (TPT)

After loading the ADT.VLX file into the drawing, complete the following steps to insert a Telstra Pit:

1. Enter **TPT** in the command line then follow the prompts below:



Prompt	Action/explanation
PLEASE PICK AN INSERTION POINT OR PRESS Enter TO FINISH	Select the location for the Telstra pit.
PLEASE ENTER TELSTRA PIT TYPE, (M) for MANHOLE, Enter FOR (5)	Press <Enter> to accept 5 , enter a different number, or enter M and press <Enter>.

Note: To exit the loop of Telstra Pit creation, press <Enter> when asked to pick an insertion point again.

5.11 Smart places non-premises locations (NPL)

Smart place products enable connection to locations that are not classified as premises. These locations include:

- Traffic Light Controller Cabinets (TUC)
- CCTV Cameras
- Utility Sensors
- Electronic Signs
- Public WiFi

Where a smart place is required within an estate, a P50 link conduit is required to connect to the customer demarcation pit. The demarcation pit must be a type 2 pit. An additional P20 will be required to link to the NPL. Refer to section 6. Smart places, in [1] NBN-TE-CTO-194 New Developments – Deployment of the nbn Pit and Conduit Network, for specific design and construction details.

5.11.1 ADT command (PIT)

After loading the ADT.VLX file into the drawing, complete the following steps to insert a demarcation pit.

1. Enter **PIT** in the command line, then follow the prompts below:

Prompt	Action/explanation
Please Pick an insertion point or press Enter to Finish.	Left click where you want the pit to be placed. Your choice of insertion point will be adjusted by the ADT to ensure the pit is parallel to the nearest cadastre layer line and is at an optimal distance from that line. Note: Demarcation pits can be installed inside Public Owner Space (POS) or reserves.

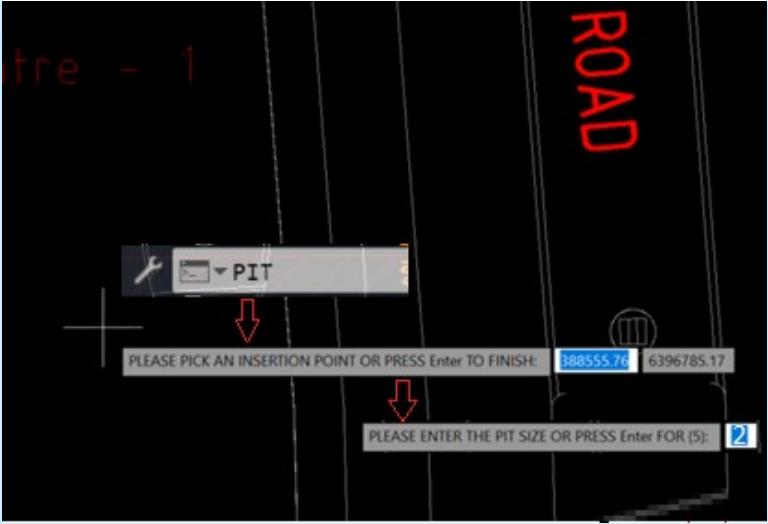
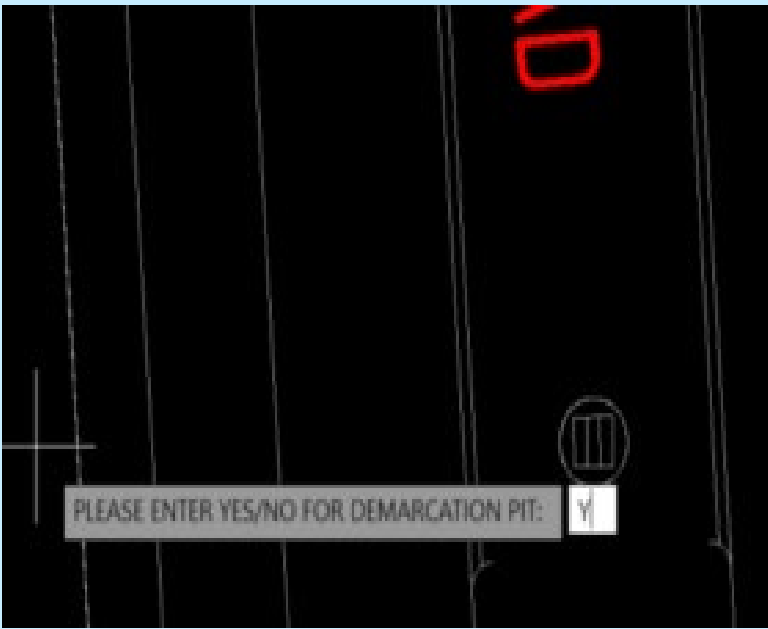

Prompt	Action/explanation
	
<p>Please enter the pit size, (2), Press Enter:</p>	<p>Acceptable Pit Size for demarcation pit is a type 2 pit, as per Table 7. Pit types.</p>
<p>Please Specify whether the pit is a Demarcation pit or not:</p>	<p>Enter Y for Demarcation pit.</p>  <p>Note: for a standard pit, enter NO.</p>

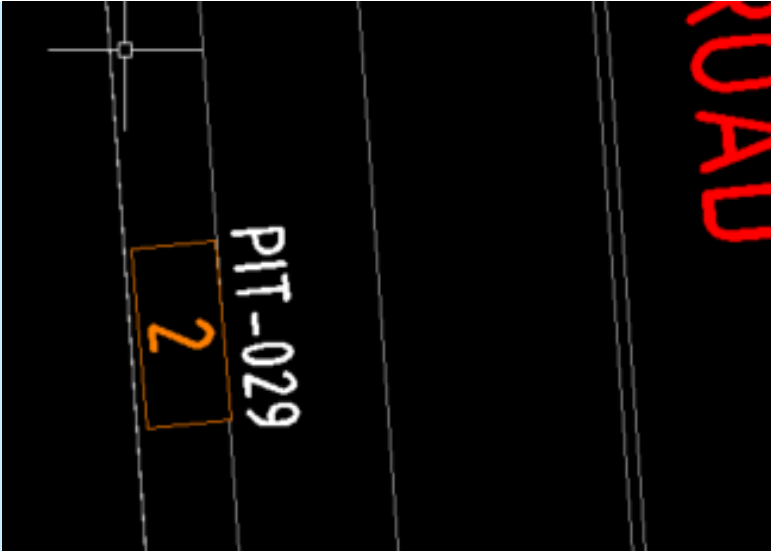

Prompt	Action/explanation
	

Check Pit attributes

Double-click on the pit to check pit attributes to confirm whether the pit is a demarcation pit or not.

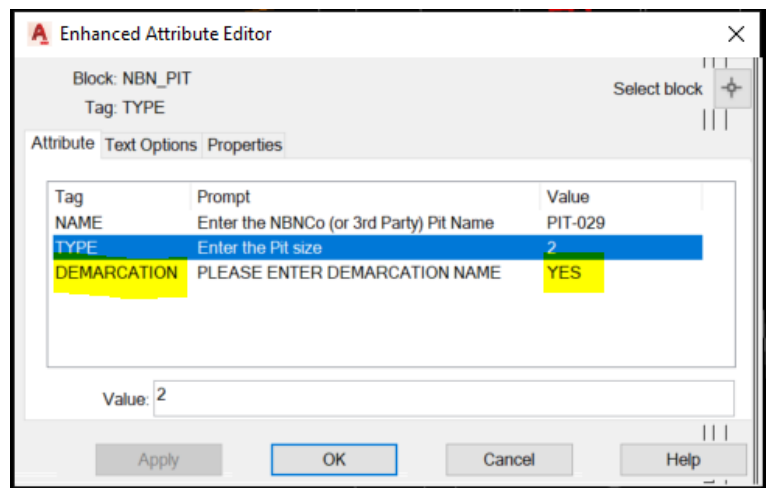

Please Use DCT command to Join infrastructure.

Use the standard **DCT** command to make the P50 connection between the standard **nbn**[®] network to the Demarcation pit, and from the Demarcation pit to the NPL location P20 lead-in Duct.

5.11.2 ADT command (ADD)

After loading the ADT.VLX file into the drawing, complete the following steps to insert an address:

1. Enter **ADD** at command line then follow the prompts.

The address command counts the existing addresses inside the development stage boundary



2. Click **OK** and follow the prompts below:

Prompt	Explanation/Action
<p>Please pick an insertion point:</p>	<p>Select the text representing the street name.</p> <p>Note: This prompt is asking you to pick an insertion point for the address block. Yet, your very first insertion point should always be the street name closest to the Cabinet or pole. If NPL is on a corner of a road, then select the major highway/road over the minor road which you are going to create addresses. You must select a street name from the L140 Addresses layer. The ADD command does not work with other layers' street name texts.</p> <div data-bbox="619 795 1094 1198" data-label="Image"> </div> <p>Above is an example of the message displayed when the street name is first selected or changed.</p>

<p>Please pick an insertion point:</p>	<p>Select the NPL location .</p>
<p>Please enter Premise</p>	<p>Enter SPECIAL for NPL.</p> <div data-bbox="619 1429 1305 1720" data-label="Image"> </div> <p>Note: For a standard address enter YES.</p> <p>Press Enter for blank entry or enter lot number if street number is known.</p> <p>Note: Optional entry and is typically left blank for NPL. Press <Enter> to accept the default Blank value. If you choose to enter a number, the tool will accept the assigned number but can also be changed in attribute by double clicking on the address/ building name.</p>



Prompt	Explanation/Action
Please Enter Building Name then press Enter	Enter free text description e.g: <ul style="list-style-type: none"> • Traffic Light Controller Cabinet (TUC) • CCTV Cameras • Utility Sensors • Electronic Signs • Public WiFi

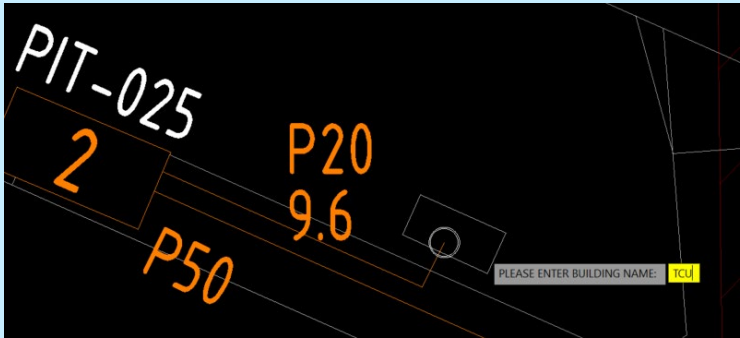

3. Double click on Building type to check attributes:

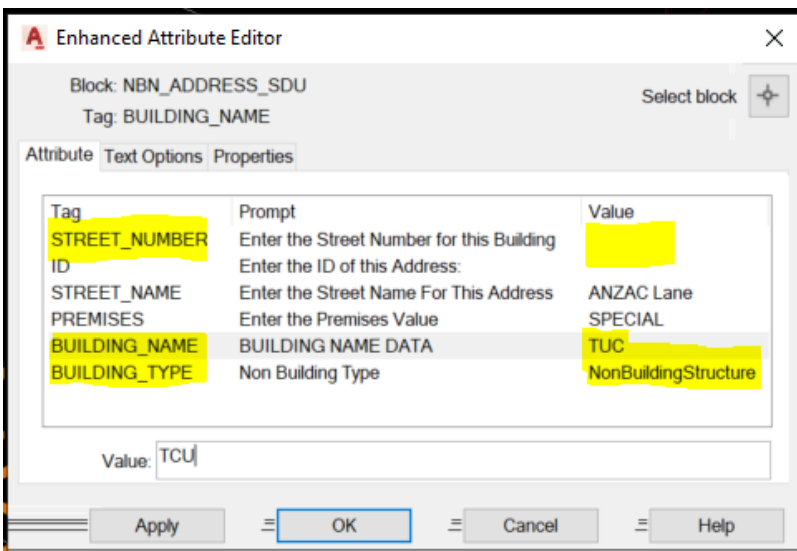
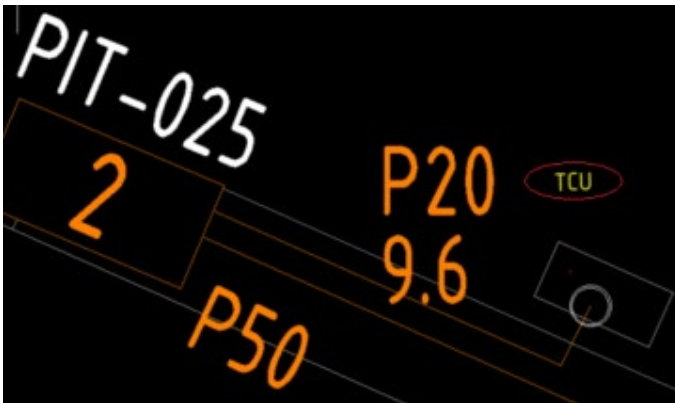



5.12 Bill of materials (BOM)

5.12.1 Drawing requirements

It is important to include a BOM (Bill of Materials) in your drawing.

The ATD will place the BOM on model view using the **NBN_BOM** in **0-GENERAL-NOTES** layer. Refer to the table below for **NBN_BOM** block attributes.

Table 13. NBN_BOM block attributes

Attribute	Explanation
PIT2	Total number of Pit 2
PIT5	Total number of Pit 5
PIT6	Total number of Pit 6
PIT8	Total number of Pit 8
PIT9	Total number of Pit 9
P100	Total number of P100 Conduits
LP100	Total length of P100 Conduits
P50	Total number of P50 Conduits
LP50	Total length of P50 Conduits
P20	Total number of P20 Conduits
LP20	Total length of P20 Conduits
PIT	Total number of pits (all sizes)
MHL	Total number of Manholes
CONDUIT	Total number of conduits (all sizes)
LENGTH	Total length of conduits (all sizes)
LOTS	Total number of lots



BILL OF MATERIAL				
NO OF LOTS:87				
PITS		DUCTS		
SIZE	QTY	SIZE	QTY	MTRS
2	13	P100	38	1322
5	16	P50	15	311.4
6	3	P20	87	1148.8
8	6			
9	0			
TOTAL NUMBER OF PITS:		38		
TOTAL NUMBER OF MANHOLES:		1		
TOTAL NUMBER OF CONDUITS:		140		
TOTAL LENGTH OF CONDUITS:		2782.2		

Figure 13. Example of BOM in the drawing

Note:



- A BOM must only be created after a successful run of the QA command.
- The BOM summary is done for pits, ducts and lots inside the current development stage boundary only.
- You must insert the BOM on the model view.
- You can scale the block up or down if necessary.

5.12.2 ADT command (BOM)

After loading the ADT.VLX file into the drawing, complete the following steps to capture the BOM:

1. Enter **BOM** in the command line.
2. At the prompt **PLEASE PICK AN INSERTION POINT FOR BOM**, pick a point. The snap point is at the top left corner of the block.



5.13 Quality audit for pit and pipe design

The **QA** command helps you audit your design before submitting to **nbn**. Refer to the table below for the QA tests:

Table 14. QA command

Item	Description
Development Information	Checks if: <ul style="list-style-type: none"> • Development Information block is inserted. • All fields are populated.
Boundary Check	Checks if: <ul style="list-style-type: none"> • One (and only one) current development stage boundary, drawn with AutoCAD polyline, is present in the L331 NBN Boundaries – GDAs layer. • There are no AutoCAD lines in the L331 NBN Boundaries – GDAs layer.
Special cases (QA run against an unfinished design by mistake)	Checks if: <ul style="list-style-type: none"> • The only ducts present in the drawing are road crossings. • There are no ducts inside the development stage boundary. • There are any pits not connected to any duct.
Pit Check	Checks if: <ul style="list-style-type: none"> • All nbn[®] pits and manholes are set to the right layer and right colour. • All nbn[®] pits are the right type (2, 5, 6, 8 or 9). • No active pits are outside the development boundary. <p>Note: Previous stage pits connected to the current stage must be coloured Yellow (2). The new tool drags pits back into L462 automatically.</p> Performs the following correction: <ul style="list-style-type: none"> • Renumbers pits sequentially starting from one.
Duct check	Checks if: <ul style="list-style-type: none"> • All ducts have XData attached. • All ducts have correctly snapped start and end points (to pits/endcaps).



5.13.1 ADT command (QA)

Use the following steps to run the Quality Audit:

1. Enter **QA** in the command line.

The QA command will run, and you must fix any faulty items that are found.

If the QA command finds faulty items that need manual correction, it inserts an **NBN_FIX** block with commentary text.

Note: The QA command works in steps. Upon the completion of one step it moves to the next step, so it is extremely important to follow through with the QA command and fix all issues.

Refer to the table below for an explanation of **NBN_FIX** errors.

Note: Errors will be tagged with an **NBN_FIX** block (yellow circle with a short error message).

Table 15. NBN_FIX text description

Error text	Explanation	Required action
TYPE	Pit type is not 2, 5, 6, 8 or 9 or MHL.	Correct the pit type attribute NBN_PIT block.
NO XDATA	Duct Polyline with no XData attached. This error usually means that a problem with one of the ducts was found, like a polyline not created with the DCT command.	Delete the Duct and re-build with the DCT command.
NO CONNECTION	Orphan pit, or a pit not properly snapped to the duct end, or a duct without a pit/end cap at its start or end.	Make sure there are no orphan pits or unattached duct ends.
SHORT DUCT	Duct polyline length is 2.5 m or less.	You are allowed to draw ducts longer than you need, but the desired length can be entered at the DCT command prompt. That value will be shown in the annotation and used in the BOM summaries.



If the Quality Audit is successful, the following message will display:

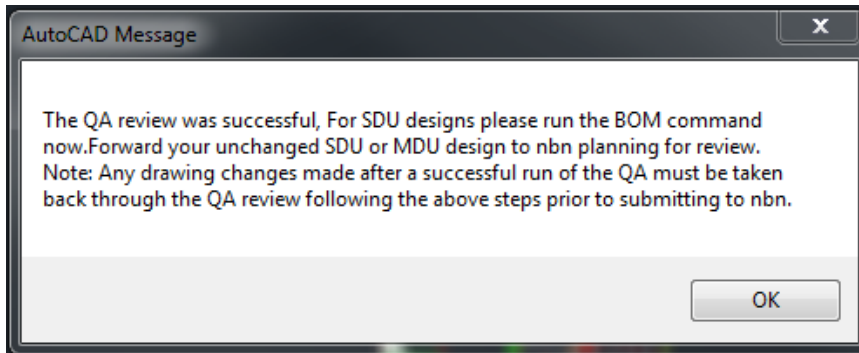

Note:

- This message also advises you to never make changes (apart from running the BOM command) between the last successful run of the QA command and actual emailing of your drawing to **nbn** for review.
- As-Built designs must be converted to Red after the BOM command has been run and then submitted to **nbn** for review.
- You should not simply rely on the ADT QA to check your design and you must independently ensure that your design complies with all of the requirements of the document [1] NBN-TE-CTO-194 New Developments – Deployment of the **nbn** Pit and Conduit Network and any other applicable specifications or requirements under your agreement with nbn.





6 Pathway drafting guidelines

This section describes the methods of data capture to assist you in complying with **nbn** CAD and database compatibility standards.

6.1 Cadastre layer

Before you begin, ensure the cadastre (or property survey data) has been copied into the **L141 Cadastre** layer.



Note: The PIT command will not work if the cadastre layer is not set to **L141 Cadastre**.

Keep the cadastre layer as simple as possible.

The **nbn** Internal Drawing Quality Audit/Conversion tool creates a polygon out of any line work that looks like a polygon visually, because polygons are expected to be lot boundaries primarily.

Unnecessary cadastre layer imagery (i.e. other utilities and services, excessive detail) will slow the processing of your drawing considerably, causing a queue to form. This will result in a delay in the review of your and other people's drawings.

The Cadastre layer must contain only the line work helpful with pathways and equipment placement when using the ADT commands and must also provide sufficient visual reference for easy drawing review by **nbn** (i.e. Address, Street name(s), unit or apartment numbers, equipment location(s), like floors, risers, communications room or cupboard).



Figure 14. Good cadastre layer example



6.2 Current development stage boundary

The Current Development Boundary must go around the MDU development drafting area. The drafting area is inclusive of all street facing premises and pit and pipe connectivity of these premises must link to the internal pit and pipe of the development.

The ADT tool works inside the boundary. The boundary must consist of one closed polyline. It must be in the **L331 NBN Boundaries - GDAs** layer and the boundary colour must be **ByLayer**.



Figure 15. Current development stage boundary

6.3 Development information

Development information must be present in the drawing.



Note: All fields in the development information block **NBN_MDU_NDI** should be populated. The **NBN_MDU_NDI** block should be in the **0-GENERAL-NOTES** layer.

Table 16. Development block attributes

Attribute	Description
DEV_NAME	Development name
DEV_COMP	Development company
DEV_ADD	Development address
DEV_NBNREF	nbn Reference number for development
DEV_STG	Development stage



Attribute	Description
DEV_REP	Development authorised representative
DEV_MOB	Authorised representative's phone number
DEV_EML	Authorised representative's email
DEV_LEVEL	Number of levels
DEV_PREM	Number of premises
DEV_FLOOR	Number of like floor layouts
DEV_REV	Design revision

6.3.1 ADT command for the Development Block

1. Enter **NBN_MDU_NDI** in the command line.

The program will ask you to pick an insertion point.

The program will then ask you to populate the following criteria, press **<Enter>** to move to the next item:

- Development name
- Development company
- Development address
- **nbn** Reference number for development (This is the ID provided by **nbn** to the Developer)
- Development stage
- Development authorised representative
- Authorised representative phone number
- Authorised representative email
- Number of levels
- Number of premises
- Number of like floor layouts
- Design revision

Note: Do not press **<Esc>** as it cancels the command.



6.4 Addresses

Refer to the table below for **NBN_ADDRESS** block attributes.

Table 17. Address block attributes

Attribute	Prompt	Explanation
STREET_NUMBER	Enter the street number for this building.	This is the lot number of the current stage.
ID	Enter the GNAF ID of this address.	This attribute is used for data translations and should be left empty.
STREET_NAME	Enter the street name.	This is the street name for the current stage. It contains both the street name and street type e.g. MARBLE LANE.



Note: The combination of the **STREET_NUMBER** and **STREET_NAME** attribute values must be unique i.e. each street address text has to be unique. You may use the street number prefix or suffix, such as 1A, if necessary.

6.4.1 ADT command (ADD)

After loading the ADT.VLX file into the drawing, complete the following steps to insert an address:

1. Enter **ADD** in the command line then follow the prompts.

The address command counts the existing addresses inside the development stage boundary and displays as the number of 'lots'.

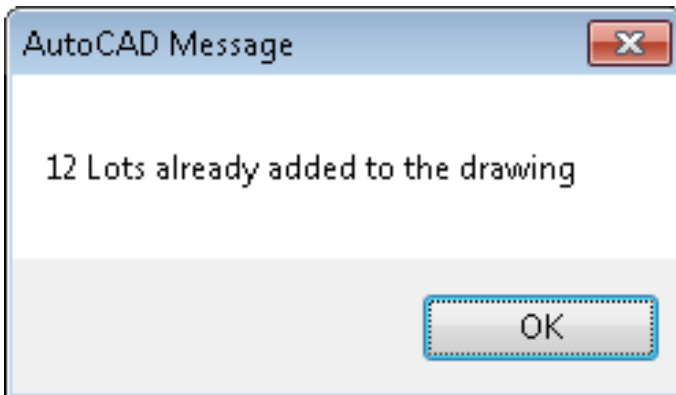

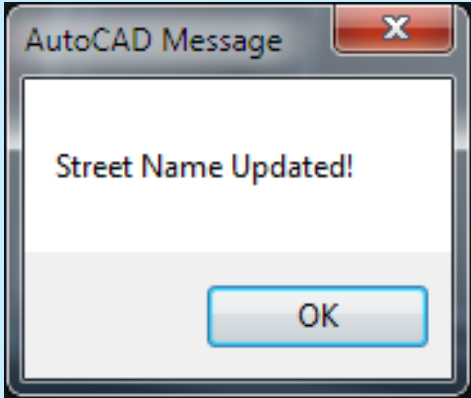

2. Click **OK** and follow the prompts below:

Prompt	Action/explanation
Please pick an insertion point	<p>Select the text representing the street name.</p> <p>Note: This prompt is asking you to pick an insertion point for the address block. Yet, your very first insertion point should always be the street name along which you are going to create addresses. You must select a street name from the L140 Addresses layer. The ADD command does not work with other layers' street name texts.</p>  <p>Above is an example of the message displayed when the street name is first selected or changed.</p>
Please pick an insertion point:	Pick the lot number location.
Please enter lot number or press Enter for (x):	<p>Enter the lot number with the desired prefix or suffix.</p> <p>Note: You can enter the lot number or press <Enter> or <Space> to accept the default value (x) offered.</p> <p>If you choose to prefix or suffix lot numbers with letters (i.e. 1A, A1) the tool is capable of automatically assigning prefix and suffix letters for you.</p> <p>Neither suffix nor prefix get incremented automatically in alphabetic order when you click next insertion point. For example, instead of the 101A, 101B, 101C you might be expecting, the generated sequence will be 101A, 102A, 103A.</p>
Please pick an insertion point:	<p>You are now in the loop of creating new addresses. From here on you can left-click at a new insertion point, then press <Enter> or <Space> to keep creating as many addresses as you need - if you are happy with the automatically generated lot number value.</p> <p>Other actions at this prompt:</p>



Prompt	Action/explanation
	<ul style="list-style-type: none"> Pick a different street name to start creating addresses along that street. Press <Enter> or <Space> to finish the ADD command.
Please enter lot number or press Enter for (xx):	Lot number (xx) offered as a default will be the previous value incremented by one. Accept by pressing <Enter> or <Space>. Alternatively, edit the lot number as described above.

6.5 MDU ADT commands

Table 18. MDU ADT commands

MDU commands	Description
CTR	Cable Tray: Allows a cable tray to be inserted into the design cadastre layout.
COMM	Communication equipment: Allows different types of nbn communication equipment (PDH, CTL, FDT, CET) to be selected.
MDU_DCT	Duct: Allows difference types of conduit (P100, P50, P20) to be selected. Note: P50 can only be used for the truncation conduit on any level between risers and access panels.
NTD	Network Termination Device: Allows different types of NTD [NTD, FIP, LIFT, SEC] to be selected.
OBBU	Optional Battery Backup Unit: Allows OBBUs to be inserted. Note: These are mandatory for essential service NTDs i.e. FIP, LIFT, SEC; and optional for premises NTDs.
PET	Penetration: Reflects the size (inside diameter) of a penetration provided between floors.
RISER	Riser: Represents the riser cupboard on each level of the development.
MDU_QA	Quality Audit: Performs a Quality Audit of the MDU pathway design.
AP	Access Panel: Represents an access panel. Note: Where a combination of cable tray and conduit is used for cabling from the telecommunications riser/closet to the living unit, access panels must be provided.



6.5.1 Riser (Riser)

1. Enter **Riser** in the command line.
The program will ask you to pick an insertion point.
Note: Do not press <Esc> as it cancels the command.
2. Press <Enter> to finish.

6.5.2 Access panel (AP)

1. Enter **AP** in the command line.
The program will ask you to pick an insertion point.
Note: Do not press <Esc> as it cancels the command.
2. Press <Enter> to finish.

6.5.3 Penetration (PET)

3. Enter **PET** in the command line.
The program will ask you to pick an insertion point.
Note: Do not press <Esc> as it cancels the command.
4. Press <Enter> to finish.

6.5.4 Optional Battery Backup PSU (OBBPSU)

1. Enter **OBBU** in the command line.
The program will ask you to pick an insertion point.
Note: Do not press <Esc> as it cancels the command.
2. Press <Enter> to finish.

6.5.5 NTD (NTD)

1. Enter **NTD** in the command line.
The program will ask you to pick an insertion point.
The program will then ask you to select the **nbn** NTD type (NTD, FIP, LIFT, SEC).
Note: Do not press <Esc> as it cancels the command.
2. Press <Enter> to finish.

6.5.6 Building distribution equipment (PDH, CTL, FDT, CET)

1. Enter **COMM** in the command line.
The program will ask you to pick an insertion point.
2. Choose **nbn COMM Type** and select the COMM type (PDH, CTL, FDT, CET).
Note: Do not press <Esc> as it cancels the command.



3. Press <Enter> to finish.

6.5.7 Cable tray (CTR)

1. Enter **CTR** in the command line.

The program will ask you to specify the start point of the cable tray and continue your cable tray line to the next riser, access panel or penetration.

Note: Do not press <Esc> as it cancels the command.

2. Press <Enter> when you finish drawing the cable tray.

The program will draw a Polyline representing a cable tray.

3. Enter the cable tray length or press <Enter> for the calculated length.

6.5.8 MDU truncation of pathway conduit (MDU_DCT)

1. Enter **MDU_DCT** in the command line.

The program will ask you to specify the start point of the duct.

2. Draw the duct and press <Enter> to finish.

Note: Do not press <Esc> as it cancels the command.

3. Enter the conduit type or press <Enter> to accept the default (P100)

4. Enter conduit length or press <Enter> for the calculated length.

5. Select an insertion point for the duct attributes.

6. Enter the cable tray length or press <Enter> for the calculated length.

6.5.9 Duct update (DCTUPD)

1. Enter **DCTUPD** in the command line.

2. Select duct type annotation to edit the duct type.

The program will ask you to select the line the annotation is related to.

The program will ask you to enter the desired type.

3. Enter the duct type (P50).

Note: The conduit type will be updated in both the annotation and the line XData.

Similar steps are applicable if you choose to update the duct length.

6.5.10 Lead-in (DCT)

When no **NBN_PIT** is chosen as the duct end, the **DCT** command will create a Lead-In with **NBN_CAP** block as its endpoint. The **NBN_CAP** will be placed in the duct layer **L460 NBN Support – Underground**.



Note: The **nbn** preferred lead-in location at the property boundary should be confirmed with the **nbn** deployment specialist.



Refer to the table below for **NBN_CAP** attributes.

Table 19. NBN_CAP block attributes

Attribute	M/O	Prompt	Explanation
ID	M	Enter a Unique ID within this drawing for this null node.	This is the nbn identifier for the end cap and has the format NEC-XXX where XXX is a 3 digit number starting from 001 and incrementing sequentially.
TYPE	M	Enter the type for this null node.	ENDCAP

6.6 Quality audit for MDU pathway design

The **MDU_QA** command helps you audit your design before submitting to **nbn**

Refer to the table below for the QA tests.

Table 20. MDU_QA command

Item	Description
Development Information	Checks if: <ul style="list-style-type: none"> • Development Information block is inserted. • All fields are populated.
Boundary Check	Checks if: <ul style="list-style-type: none"> • One (and only one) current development stage boundary, drawn with AutoCAD polyline, is present in the L331 NBN Boundaries – GDAs layer. • There are no AutoCAD lines in the L331 NBN Boundaries – GDAs layer.
Special cases (QA run against an unfinished design by mistake)	Checks if: <ul style="list-style-type: none"> • There are no duct or cable trays inside the development stage boundary. • There are any risers, penetrations, access panels, NTDs etc. not connected to any duct or cable tray.
Pit Check	Checks if: <ul style="list-style-type: none"> • All nbn pits and manholes are set to the right layer and right colour. • All nbn pits are the right type (2, 5, 6, 8, Manhole). • No active pits are outside the development boundary.



Item	Description
	<p>Note: previous stage pits connected to the current stage must be coloured Yellow (2). The new tool drags pits back into L462 automatically.</p> <p>Performs the following correction:</p> <ul style="list-style-type: none"> • Renumbers pits sequentially starting from one.
Duct check	<p>Checks if:</p> <ul style="list-style-type: none"> • All ducts have XData attached. • All ducts have correctly snapped start and end points (to pits/endcaps).

6.6.1 ADT command (MDU_QA)

Use the following steps to run the Quality Audit:

1. Enter **MDU_QA** in the command line.

The **MDU_QA** command will run, and you must fix any faulty items that are found.

If the **MDU_QA** command finds faulty items that need manual correction, it inserts an **NBN_FIX** block with commentary text.

 **Note:** The **MDU_QA** command works in steps. Upon the completion of one step it moves to the next step, so it is extremely important to follow through with the **MDU_QA** command and fix all issues.

Refer to the table below for an explanation of **NBN_FIX** errors.

Note: Errors will be tagged with an **NBN_FIX** block (yellow circle with a short error message).

Table 21. NBN_FIX text description

Error text/message	Explanation	Required action
TYPE	Pit type is not 2, 5, 6, 8 or MHL.	Correct the pit type attribute of NBN_PIT block.
NO XDATA	<p>Duct Polyline with no XData attached.</p> <p>This error usually means that a problem with one of the ducts was found, like a polyline not created with the MDU_DCT command.</p>	Delete the Duct and re-build with the MDU_DCT command.
NO CONNECTION	Orphan pit, or a pit not properly snapped to the duct end, or a duct without a pit/end cap at its start or end.	Make sure there are no orphan pits, risers, access panels, NTDs etc or unattached duct ends.



Error text/message	Explanation	Required action
SHORT DUCT	Duct polyline length is 2.5 m or less.	You are allowed to draw ducts longer than you need, but the desired length can be entered at the MDU_DCT command prompt. That value will be shown in the annotation.
Layer	NTD/RISER/OBBU/AP/COMM	Incorrect Layer, move the item to the correct layer.
COLOUR	NTD/RISER/OBBU/AP/COMM	Incorrect Colour, change the item to the correct colour.
Risers should have both ends snapped to P50.	Where a P50 is required to connect offset risers the P50 should have its ends snapped to risers.	Draw the P50 snapping one end to a riser and the other to the offset riser.
P20 should its ends snapped to AP/Riser or NTD	A P20 should only be drawn snapping the ends to a Riser, Access Panel or NTD. Or a Cable Tray where there is a suspended accessible ceiling for commercial or retail tenancies	Draw a P20 snapped to an AP, Riser, NTD or Cable Tray.
P50 should have its one end snapped to AP/Riser	A P50 truncation duct is drawn snapping between a Riser to Riser: Riser to Access panel: Access Panel to Access Panel. A P50 should not be used to connect between any nbn equipment.	Draw the P50 truncation duct snapping to Riser, Access Panel.
P20 should not snapped between ENDCAPS	A P20 should not be drawn snapping one end to an endcap, it must be snapped between two points: Access Panel, Riser, NTD or Cable Tray	Draw a P20 snapping to an AP, Riser, NTD, or Cable Tray
Overlapping ducts are not allowed	This error occurs when two or more ducts touch or cross each other.	Draw ducts maintaining separation.
No section of conduit shall be longer than 50m between pull/draw points.	A continuous duct should not exceed 50m between pull / draw points.	Draw the duct reflecting the correct distance.
CTR length between access points should not be greater than 15m.	A Cable Tray should be drawn no further than 15m between draw points i.e. Access Panel to Access Panel.	Draw the CTR reflecting the correct distance.



Error text/message	Explanation	Required action
Duct length between Access Panels should not be greater than 15m.	A duct length should not exceed 15m between Access Panels.	Draw the duct reflecting the correct distance.
Start point is not selected.	MDU_DCT was entered in the command and has not been drawn from a start point i.e. Riser, Access Panel.	Enter MDU_DCT in the command line, select the start point, and draw the duct to the end point.

If the Quality Audit is successful, the following message will display:

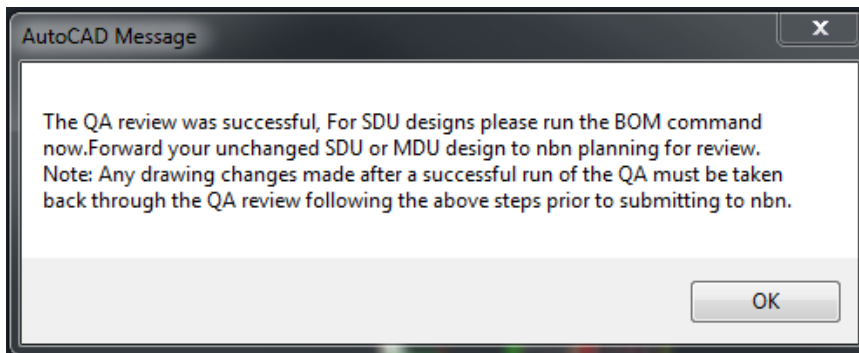

Note:

- The BOM command is for SDU designs only.
- This message also advises you to never make changes between the last successful run of the QA command and actual emailing of your drawing to **nbn** for review.
- You should not simply rely on the ADT QA to check your design and you must independently ensure that your design complies with all of the requirements of the document [1]NBN-TE-CTO-194 New Developments – Deployment of the **nbn** Pit and Conduit Network and any other applicable -specifications or requirements under your agreement with **nbn**.



7 Checklists

7.1 Pit and pipe

The following two checklists have been created to assist you in meeting **nbn**'s system and database compatibility requirements:

1. Pre-Construct Handover Checklist
2. As-Built Handover Checklist

A completed *Pre-Construct Handover Checklist* must be included with any stage design submitted for **nbn**'s comment, as evidence of having met all the required checks and data collection activities.

A completed *As-Built Handover Checklist* must be submitted with your notice of practical completion and As-Builts.

Both checklists are available from the **nbn** website from the [Upload designs | nbn \(nbnco.com.au\)](https://nbnco.com.au) page.

7.2 Pathways

The *MDU Design Checklist* has been created to assist you in meeting **nbn**'s system and database compatibility requirements.

The checklist is available from the **nbn** website from the [Upload designs | nbn \(nbnco.com.au\)](https://nbnco.com.au) page.



8 Contact us

8.1 Design submission and queries

All pit and pipe design submissions are done via the **nbn** New Developments portal.

All design review and corrective actions queries should be actioned through the **nbn** New Developments portal.

8.2 Support

For ADT or design submission support, contact your Deployment Specialist or **nbn** contact in the first instance.

For any additional ADT enquiries relating to technical support or issues email:

NBNADTQuestions@nbnco.com.au.

Hours: 9:30am – 4:30pm AEST Monday to Friday.



9 Glossary

Term	Description
AEST	Australian Eastern Standard Time
AP	Access Panel
ATD	AutoCAD Architectural Desktop
BOM	Bill of Materials
CAD	Computer Aided Design
CAP	End Cap
CCTV	Closed Circuit Television
CET	Communications Earth Terminal
COMM	Communications Equipment
COMP	Company
CTL	Cable Transition Location
CTR	Cable Tray
DCT	Duct
DCTUPD	Duct Update
DWG	Drawing file format in AutoCAD
EML	Email
EPR	Earth Potential Rise
FDH	Fibre Distribution Hub
FDT	Fibre Distribution Terminal
FIP	Fire Indicator Panel
GDA	Geocentric Datum
GNAF	Geo-coded National Address File
MDU	Multi Dwelling Unit
MGA	Map Grid of Australia
MHL	Manhole
NDI	NBN Development Information
NPL	Non-Premises Location



Term	Description
NTD	Network Termination Device
OBBPSU	Optional Battery Backup Power Supply Unit
OBBU	Optional Battery Backup
PDF	Portable Document Format
PDH	Premises Distribution Hub
PET	Penetration
PNI	Physical Network Inventory
POS	Public Owner Space
PSU	Power Supply Unit
QA	Quality Audit
REP	Representative
REV	Revision
SDU	Single Dwelling Unit
SEC	Security
STG	Stage
STR	Shared Trench
TBA	To Be Assigned
TO	Telecommunications Outlet
TPT	Telstra Pit
TUC	Traffic light Controller Unit
UTM	Universal Transverse Mercator
VLX	AutoCAD Visual List Processing Command File
XD	Extended Entity Data
XDATA	Extended Entity Data